



Is Now Part of



**ON Semiconductor®**

To learn more about ON Semiconductor, please visit our website at  
[www.onsemi.com](http://www.onsemi.com)

Please note: As part of the Fairchild Semiconductor integration, some of the Fairchild orderable part numbers will need to change in order to meet ON Semiconductor's system requirements. Since the ON Semiconductor product management systems do not have the ability to manage part nomenclature that utilizes an underscore (\_), the underscore (\_) in the Fairchild part numbers will be changed to a dash (-). This document may contain device numbers with an underscore (\_). Please check the ON Semiconductor website to verify the updated device numbers. The most current and up-to-date ordering information can be found at [www.onsemi.com](http://www.onsemi.com). Please email any questions regarding the system integration to [Fairchild\\_questions@onsemi.com](mailto:Fairchild_questions@onsemi.com).

ON Semiconductor and the ON Semiconductor logo are trademarks of Semiconductor Components Industries, LLC dba ON Semiconductor or its subsidiaries in the United States and/or other countries. ON Semiconductor owns the rights to a number of patents, trademarks, copyrights, trade secrets, and other intellectual property. A listing of ON Semiconductor's product/patent coverage may be accessed at [www.onsemi.com/site/pdf/Patent-Marking.pdf](http://www.onsemi.com/site/pdf/Patent-Marking.pdf). ON Semiconductor reserves the right to make changes without further notice to any products herein. ON Semiconductor makes no warranty, representation or guarantee regarding the suitability of its products for any particular purpose, nor does ON Semiconductor assume any liability arising out of the application or use of any product or circuit, and specifically disclaims any and all liability, including without limitation special, consequential or incidental damages. Buyer is responsible for its products and applications using ON Semiconductor products, including compliance with all laws, regulations and safety requirements or standards, regardless of any support or applications information provided by ON Semiconductor. "Typical" parameters which may be provided in ON Semiconductor data sheets and/or specifications can and do vary in different applications and actual performance may vary over time. All operating parameters, including "Typicals" must be validated for each customer application by customer's technical experts. ON Semiconductor does not convey any license under its patent rights nor the rights of others. ON Semiconductor products are not designed, intended, or authorized for use as a critical component in life support systems or any FDA Class 3 medical devices or medical devices with a same or similar classification in a foreign jurisdiction or any devices intended for implantation in the human body. Should Buyer purchase or use ON Semiconductor products for any such unintended or unauthorized application, Buyer shall indemnify and hold ON Semiconductor and its officers, employees, subsidiaries, affiliates, and distributors harmless against all claims, costs, damages, and expenses, and reasonable attorney fees arising out of, directly or indirectly, any claim of personal injury or death associated with such unintended or unauthorized use, even if such claim alleges that ON Semiconductor was negligent regarding the design or manufacture of the part. ON Semiconductor is an Equal Opportunity/Affirmative Action Employer. This literature is subject to all applicable copyright laws and is not for resale in any manner.

# FDS6982AS

## Dual Notebook Power Supply N-Channel PowerTrench® SyncFET™ General Description

The FDS6982AS is designed to replace two single SO-8 MOSFETs and Schottky diode in synchronous DC:DC power supplies that provide various peripheral voltages for notebook computers and other battery powered electronic devices. FDS6982AS contains two unique 30V, N-channel, logic level, PowerTrench MOSFETs designed to maximize power conversion efficiency. The high-side switch (Q1) is designed with specific emphasis on reducing switching losses while the low-side switch (Q2) is optimized to reduce conduction losses. Q2 also includes an integrated Schottky diode using Fairchild's monolithic SyncFET technology.

### Features

- **Q2:** Optimized to minimize conduction losses  
Includes SyncFET Schottky body diode  
8.6A, 30V  $R_{DS(on)} \text{ max} = 13.5\text{m}\Omega @ V_{GS} = 10\text{V}$   
 $R_{DS(on)} \text{ max} = 16.5\text{m}\Omega @ V_{GS} = 4.5\text{V}$
- Low gate charge (21nC typical)
- **Q1:** Optimized for low switching losses  
6.3A, 30V  $R_{DS(on)} \text{ max} = 28.0\text{m}\Omega @ V_{GS} = 10\text{V}$   
 $R_{DS(on)} \text{ max} = 35.0\text{m}\Omega @ V_{GS} = 4.5\text{V}$
- Low gate charge (11nC typical)

### Applications

- Notebook

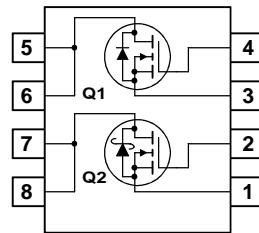
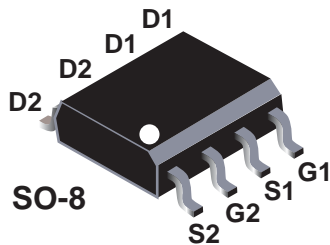

### Absolute Maximum Ratings $T_A = 25^\circ\text{C}$ unless otherwise noted

| Symbol         | Parameter  | Q2          | Q1       | Units            |
|----------------|--|-------------|----------|------------------|
| $V_{DSS}$      | Drain-Source Voltage                             | 30          | 30       | V                |
| $V_{GSS}$      | Gate-Source Voltage                              | $\pm 20$    | $\pm 20$ | V                |
| $I_D$          | Drain Current - Continuous (Note 1a)             | 8.6         | 6.3      | A                |
|                | - Pulsed   | 30          | 20       |                  |
| $P_D$          | Power Dissipation for Dual Operation             | 2           |          | W                |
|                | Power Dissipation for Single Operation (Note 1a) | 1.6         |          |                  |
|                | (Note 1b)  | 1           |          |                  |
|                | (Note 1c)  | 0.9         |          |                  |
| $T_J, T_{STG}$ | Operating and Storage Junction Temperature Range | -55 to +150 |          | $^\circ\text{C}$ |

### Thermal Characteristics

|                 |   |    |                    |
|-----------------|---|----|--------------------|
| $R_{\theta JA}$ | Thermal Resistance, Junction-to-Ambient (Note 1a) | 78 | $^\circ\text{C/W}$ |
| $R_{\theta JC}$ | Thermal Resistance, Junction-to-Case (Note 1)     | 40 | $^\circ\text{C/W}$ |

### Package Marking and Ordering Information

| Device Marking | Device    | Reel Size | Tape width | Quantity   |
|----------------|-----------|-----------|------------|------------|
| FDS6982AS      | FDS6982AS | 13"       | 12mm       | 2500 units |

**Electrical Characteristics** $T_A = 25^\circ\text{C}$  unless otherwise noted

| Symbol                               | Parameter                                 | Test Conditions   | Type     | Min      | Typ      | Max       | Units                |
|--------------------------------------|---|---|----------|----------|----------|-----------|----------------------|
| <b>Off Characteristics</b>           |   |   |          |          |          |           |                      |
| $BV_{DSS}$                           | Drain-Source Breakdown Voltage            | $V_{GS} = 0\text{ V}, I_D = 1\text{ mA}$<br>$V_{GS} = 0\text{ V}, I_D = 250\text{ }\mu\text{A}$                             | Q2<br>Q1 | 30<br>30 |          |           | V                    |
| $\frac{\Delta BV_{DSS}}{\Delta T_J}$ | Breakdown Voltage Temperature Coefficient | $I_D = 1\text{ mA}$ , Referenced to $25^\circ\text{C}$<br>$I_D = 250\text{ }\mu\text{A}$ , Referenced to $25^\circ\text{C}$ | Q2<br>Q1 |          | 28<br>24 |           | mV/ $^\circ\text{C}$ |
| $I_{DSS}$                            | Zero Gate Voltage Drain Current           | $V_{DS} = 24\text{ V}, V_{GS} = 0\text{ V}$   | Q2<br>Q1 |          |          | 500<br>1  | $\mu\text{A}$        |
| $I_{GSS}$                            | Gate-Body Leakage                         | $V_{GS} = \pm 20\text{ V}, V_{DS} = 0\text{ V}$   | Q2<br>Q1 |          |          | $\pm 100$ | nA                   |

**On Characteristics** (Note 2)

|  |  |  |              |          |                                  |  |                      |
|--|--|--|--------------|----------|----------------------------------|--|----------------------|
| $V_{GS(th)}$                           | Gate Threshold Voltage                         | $V_{DS} = V_{GS}, I_D = 1\text{ mA}$<br>$V_{DS} = V_{GS}, I_D = 250\text{ }\mu\text{A}$  | Q2<br>Q1     | 1<br>1   | 1.4<br>1.9                       | 3<br>3                                 | V                    |
| $\frac{\Delta V_{GS(th)}}{\Delta T_J}$ | Gate Threshold Voltage Temperature Coefficient | $I_D = 1\text{ mA}$ , Referenced to $25^\circ\text{C}$<br>$I_D = 250\text{ }\mu\text{A}$ , Referenced to $25^\circ\text{C}$  | Q2<br>Q1     |          | -3.1<br>-4.3                     |  | mV/ $^\circ\text{C}$ |
| $R_{DS(on)}$                           | Static Drain-Source On-Resistance              | $V_{GS} = 10\text{ V}, I_D = 8.6\text{ A}$<br>$V_{GS} = 10\text{ V}, I_D = 8.6\text{ A}, T_J = 125^\circ\text{C}$<br>$V_{GS} = 4.5\text{ V}, I_D = 7.5\text{ A}$<br>$V_{GS} = 10\text{ V}, I_D = 6.3\text{ A}$<br>$V_{GS} = 10\text{ V}, I_D = 6.3\text{ A}, T_J = 125^\circ\text{C}$<br>$V_{GS} = 4.5\text{ V}, I_D = 5.6\text{ A}$ | Q2<br><br>Q1 |          | 11<br>16<br>13<br>20<br>26<br>25 | 13.5<br>20.0<br>16.5<br>28<br>33<br>35 | m $\Omega$           |
| $I_{D(on)}$                            | On-State Drain Current                         | $V_{GS} = 10\text{ V}, V_{DS} = 5\text{ V}$  | Q2<br>Q1     | 30<br>20 |                                  |  | A                    |
| $g_{FS}$                               | Forward Transconductance                       | $V_{DS} = 5\text{ V}, I_D = 8.6\text{ A}$<br>$V_{DS} = 5\text{ V}, I_D = 6.3\text{ A}$   | Q2<br>Q1     |          | 32<br>19                         |  | S                    |

**Dynamic Characteristics**

|           |                              |  |          |  |             |  |          |
|-----------|------------------------------|--|----------|--|-------------|--|----------|
| $C_{iss}$ | Input Capacitance            | $V_{DS} = 10\text{ V}, V_{GS} = 0\text{ V},$<br>$f = 1.0\text{ MHz}$ | Q2<br>Q1 |  | 1250<br>610 |  | pF       |
| $C_{oss}$ | Output Capacitance           |  | Q2<br>Q1 |  | 410<br>180  |  | pF       |
| $C_{rss}$ | Reverse Transfer Capacitance |  | Q2<br>Q1 |  | 130<br>85   |  | pF       |
| $R_G$     | Gate Resistance              | $V_{GS} = 15\text{ mV}, f = 1.0\text{ MHz}$                          | Q2<br>Q1 |  | 1.4<br>2.2  |  | $\Omega$ |

**Switching Characteristics** (Note 2)

|              |                     |   |          |  |          |          |    |
|--------------|---------------------|---|----------|--|----------|----------|----|
| $t_{d(on)}$  | Turn-On Delay Time  | $V_{DD} = 15\text{ V}, I_D = 1\text{ A},$<br>$V_{GS} = 10\text{ V}, R_{GEN} = 6\text{ }\Omega$  | Q2<br>Q1 |  | 9<br>10  | 18<br>20 | ns |
| $t_r$        | Turn-On Rise Time   |   | Q2<br>Q1 |  | 6<br>7   | 12<br>14 | ns |
| $t_{d(off)}$ | Turn-Off Delay Time |   | Q2<br>Q1 |  | 27<br>24 | 44<br>39 | ns |
| $t_f$        | Turn-Off Fall Time  |   | Q2<br>Q1 |  | 11<br>3  | 20<br>6  | ns |
| $t_{d(on)}$  | Turn-On Delay Time  | $V_{DD} = 15\text{ V}, I_D = 1\text{ A},$<br>$V_{GS} = 4.5\text{ V}, R_{GEN} = 6\text{ }\Omega$ | Q2<br>Q1 |  | 12<br>12 | 22<br>22 | ns |
| $t_r$        | Turn-On Rise Time   |   | Q2<br>Q1 |  | 13<br>14 | 23<br>25 | ns |
| $t_{d(off)}$ | Turn-Off Delay Time |   | Q2<br>Q1 |  | 19<br>15 | 34<br>27 | ns |
| $t_f$        | Turn-Off Fall Time  |   | Q2<br>Q1 |  | 10<br>5  | 20<br>10 | ns |

**Electrical Characteristics** (continued)  $T_A = 25^\circ\text{C}$  unless otherwise noted

| Symbol | Parameter | Test Conditions | Type | Min | Typ | Max | Units |
|--------|-----------|-----------------|------|-----|-----|-----|-------|
|--------|-----------|-----------------|------|-----|-----|-----|-------|

**Switching Characteristics** (Note 2)

|              |  |   |    |  |     |    |    |
|--------------|--|---|----|--|-----|----|----|
| $Q_{g(TOT)}$ | Total Gate Charge at $V_{gs}=10\text{V}$ | $V_{DS} = 15\text{ V}, I_D = 11.5\text{ A}$<br>$V_{DS} = 15\text{ V}, I_D = 6.3\text{ A}$ | Q2 |  | 21  | 30 | nC |
|              |  |   | Q1 |  | 11  | 15 |    |
| $Q_g$        | Total Gate Charge at $V_{gs}=5\text{V}$  |   | Q2 |  | 12  | 16 | nC |
|              |  |   | Q1 |  | 6   | 9  |    |
| $Q_{gs}$     | Gate–Source Charge                       |   | Q2 |  | 3.1 |    | nC |
|              |  |   | Q1 |  | 1.8 |    |    |
| $Q_{gd}$     | Gate–Drain Charge                        |   | Q2 |  | 3.6 |    | nC |
|              |  |   | Q1 |  | 2.4 |    |    |

**Drain–Source Diode Characteristics and Maximum Ratings**

|          |   |   |    |  |     |     |    |
|----------|---|---|----|--|-----|-----|----|
| $I_S$    | Maximum Continuous Drain-Source Diode Forward Current |   | Q2 |  |     | 3.0 | A  |
|          |   |   | Q1 |  |     | 1.3 |    |
| $T_{rr}$ | Reverse Recovery Time                                 | $I_F = 11.5\text{ A},$<br>$d_{IF}/d_t = 300\text{ A}/\mu\text{s}$ | Q2 |  | 19  |     | ns |
| $Q_{rr}$ | Reverse Recovery Charge                               | (Note 3)  |    |  | 12  |     | nC |
| $T_{rr}$ | Reverse Recovery Time                                 | $I_F = 6.3\text{ A},$<br>$d_{IF}/d_t = 100\text{ A}/\mu\text{s}$  | Q1 |  | 20  |     | ns |
| $Q_{rr}$ | Reverse Recovery Charge                               | (Note 3)  |    |  | 9   |     | nC |
| $V_{SD}$ | Drain-Source Diode Forward Voltage                    | $V_{GS} = 0\text{ V}, I_S = 3\text{ A}$ (Note 2)                  | Q2 |  | 0.5 | 0.7 | V  |
|          |   | $V_{GS} = 0\text{ V}, I_S = 6\text{ A}$ (Note 2)                  | Q2 |  | 0.6 | 1.0 |    |
|          |   | $V_{GS} = 0\text{ V}, I_S = 1.3\text{ A}$ (Note 2)                | Q1 |  | 0.8 | 1.2 |    |

**Notes:**

1.  $R_{\theta JA}$  is the sum of the junction-to-case and case-to-ambient thermal resistance where the case thermal reference is defined as the solder mounting surface of the drain pins.  $R_{\theta JC}$  is guaranteed by design while  $R_{\theta CA}$  is determined by the user's board design.

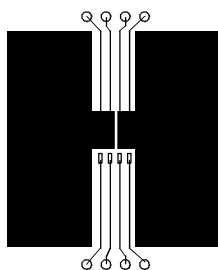

a)  $78^\circ\text{C/W}$  when mounted on a  $0.5\text{ in}^2$  pad of 2 oz copper

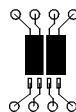

b)  $125^\circ\text{C/W}$  when mounted on a  $0.02\text{ in}^2$  pad of 2 oz copper

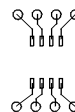

c)  $135^\circ\text{C/W}$  when mounted on a minimum pad.

Scale 1 : 1 on letter size paper

2. Pulse Test: Pulse Width <  $300\mu\text{s}$ , Duty Cycle < 2.0%

3. See "SyncFET Schottky body diode characteristics" below.

## Typical Characteristics: Q2

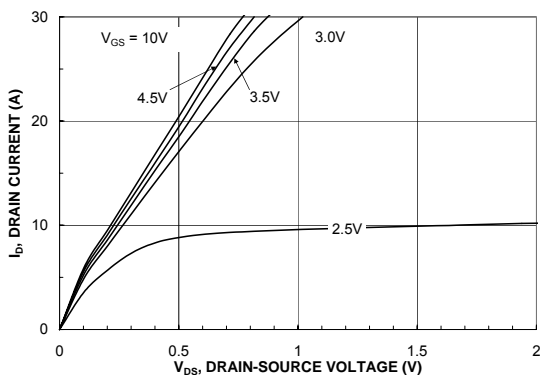

Figure 1. On-Region Characteristics.

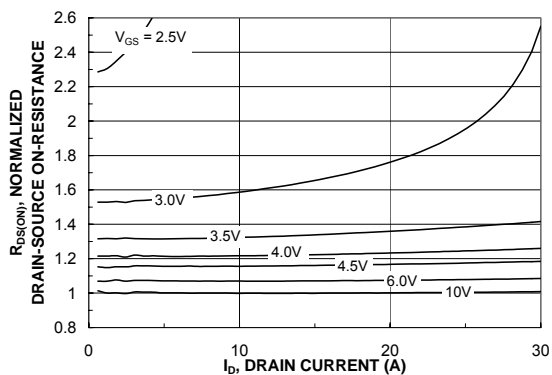

Figure 2. On-Resistance Variation with Drain Current and Gate Voltage.

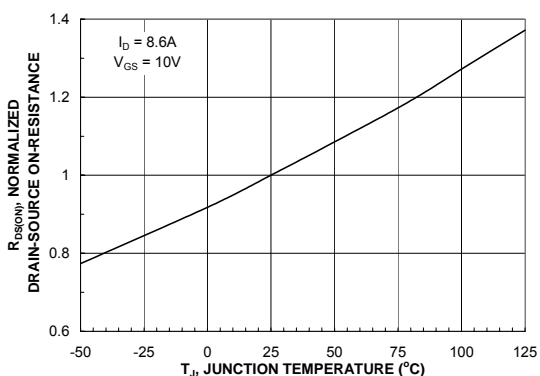

Figure 3. On-Resistance Variation with Temperature.

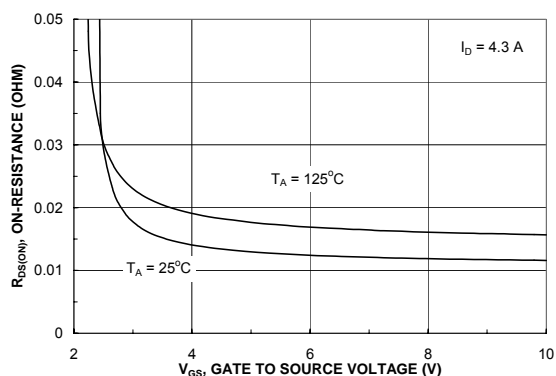

Figure 4. On-Resistance Variation with Gate-to-Source Voltage.

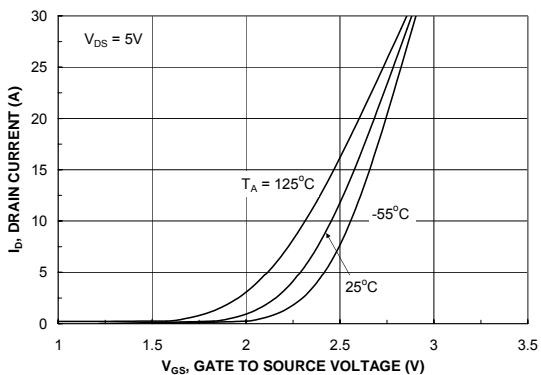

Figure 5. Transfer Characteristics.

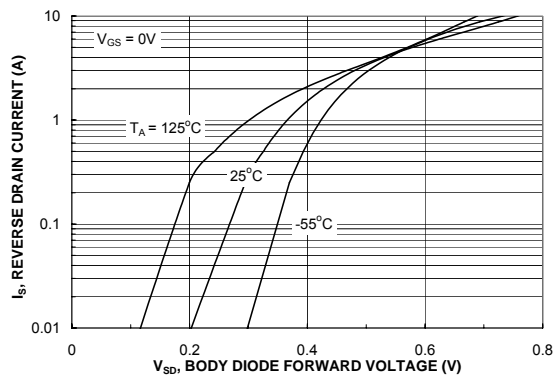

Figure 6. Body Diode Forward Voltage Variation with Source Current and Temperature.

### Typical Characteristics: Q2

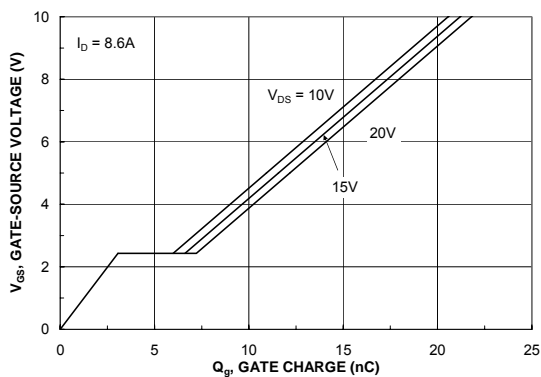

Figure 7. Gate Charge Characteristics.

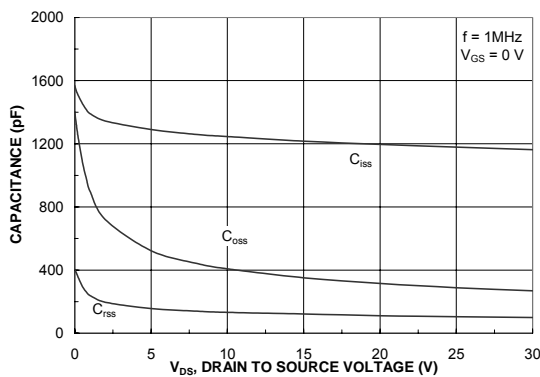

Figure 8. Capacitance Characteristics.

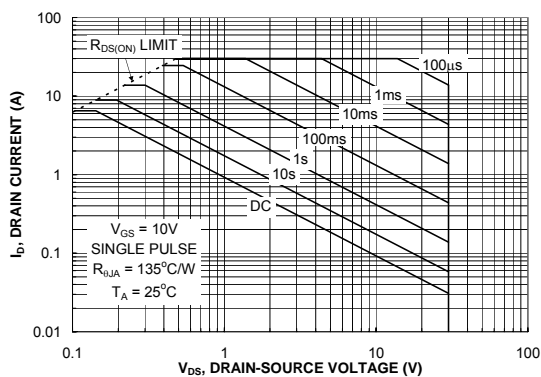

Figure 9. Maximum Safe Operating Area.

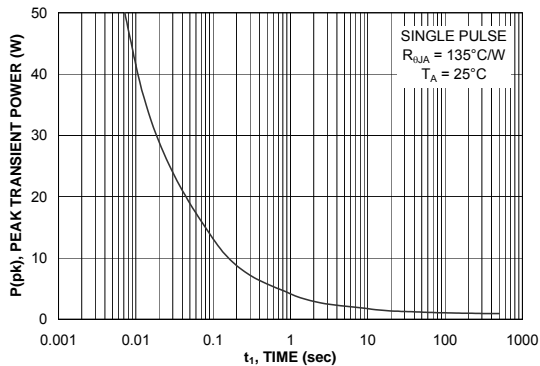

Figure 10. Single Pulse Maximum Power Dissipation.

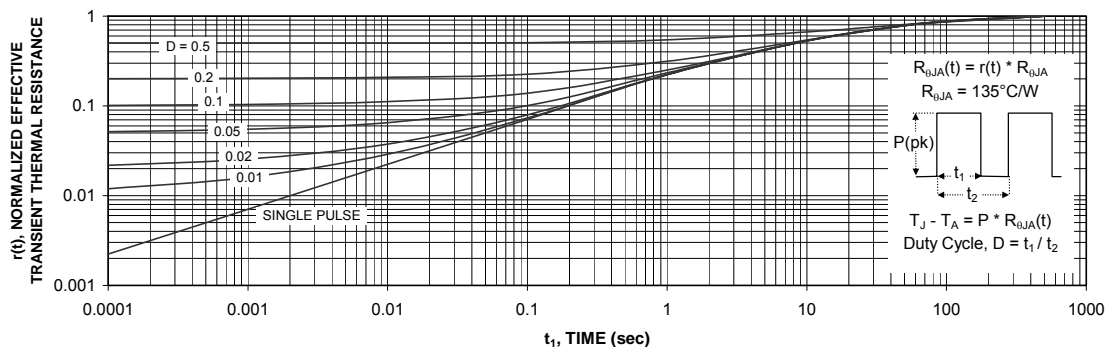

Figure 11. Transient Thermal Response Curve.

Thermal characterization performed using the conditions described in Note 1c.  
Transient thermal response will change depending on the circuit board design.

### Typical Characteristics Q1

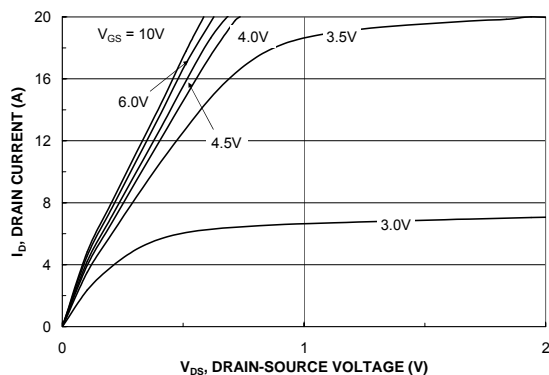

Figure 12. On-Region Characteristics.

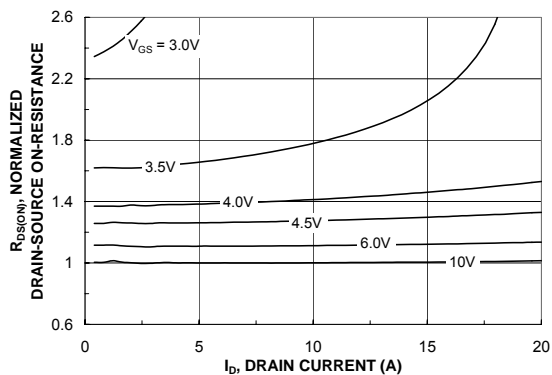

Figure 13. On-Resistance Variation with Drain Current and Gate Voltage.

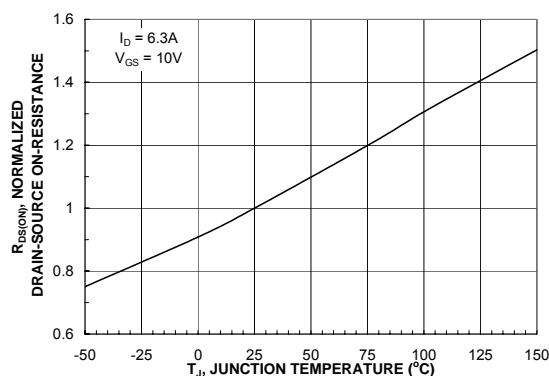

Figure 14. On-Resistance Variation with Temperature.

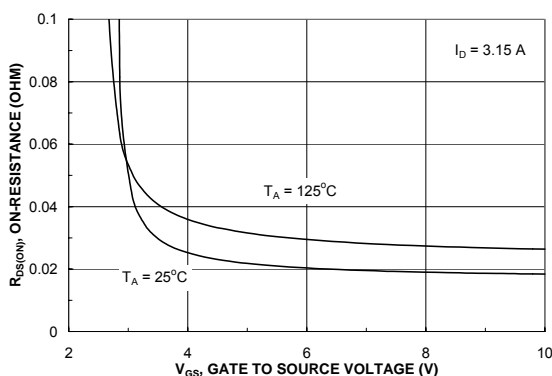

Figure 15. On-Resistance Variation with Gate-to-Source Voltage.

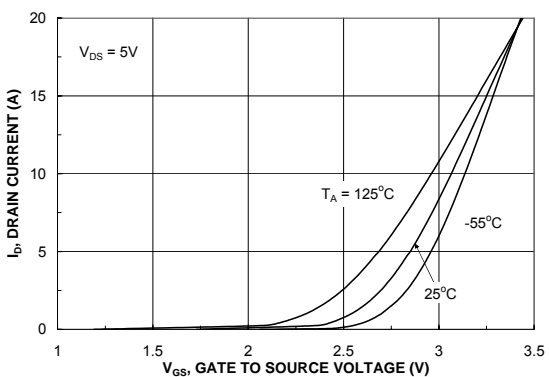

Figure 16. Transfer Characteristics.

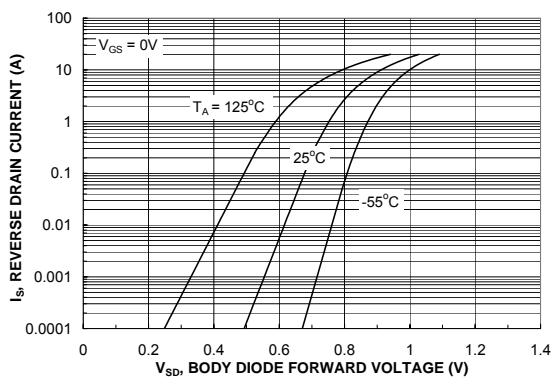

Figure 17. Body Diode Forward Voltage Variation with Source Current and Temperature.

Typical Characteristics Q1

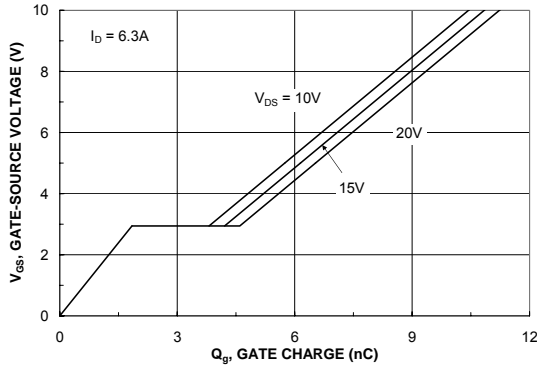

Figure 18. Gate Charge Characteristics.

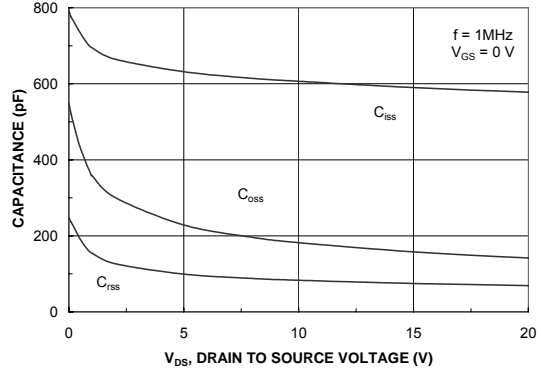

Figure 19. Capacitance Characteristics.

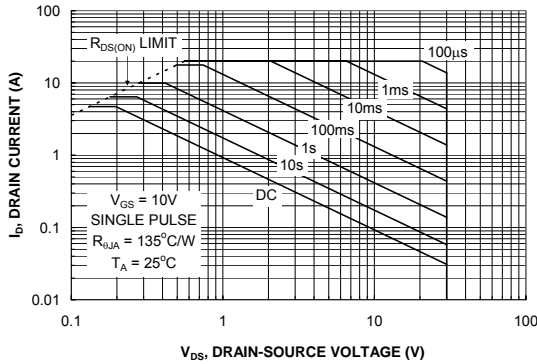

Figure 20. Maximum Safe Operating Area.

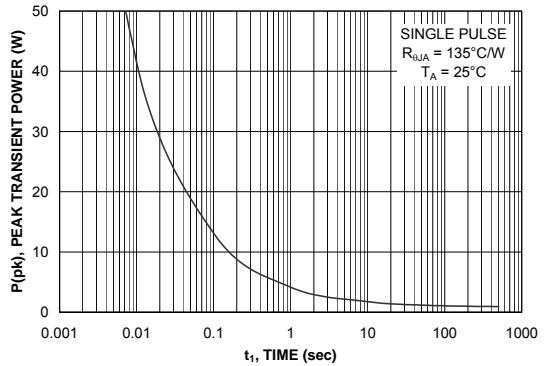

Figure 21. Single Pulse Maximum Power Dissipation.

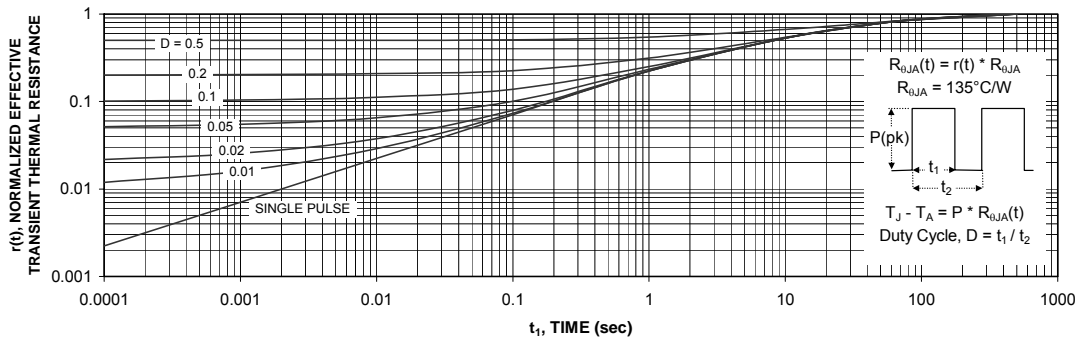

Figure 22. Transient Thermal Response Curve.

Thermal characterization performed using the conditions described in Note 1c. Transient thermal response will change depending on the circuit board design.



## Typical Characteristics (continued)

### SyncFET Schottky Body Diode Characteristics

Fairchild's SyncFET process embeds a Schottky diode in parallel with PowerTrench MOSFET. This diode exhibits similar characteristics to a discrete external Schottky diode in parallel with a MOSFET. **Figure 23** shows the reverse recovery characteristic of the FDS6982AS.

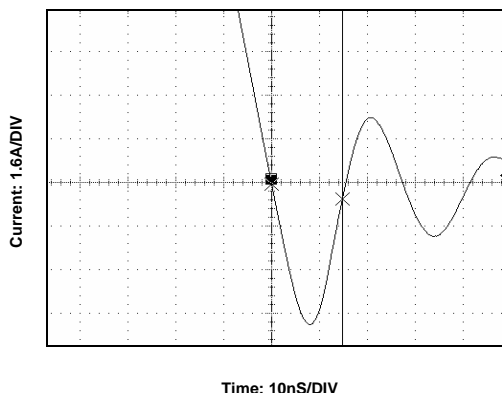

**Figure 23. FDS6982AS SyncFET body diode reverse recovery characteristic.**

For comparison purposes, **Figure 24** shows the reverse recovery characteristics of the body diode of an equivalent size MOSFET produced without SyncFET (FDS6982).

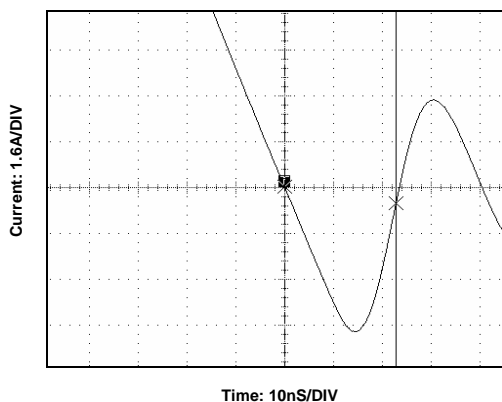

**Figure 24. Non-SyncFET (FDS6982) body diode reverse recovery characteristic.**

Schottky barrier diodes exhibit significant leakage at high temperature and high reverse voltage. This will increase the power in the device.

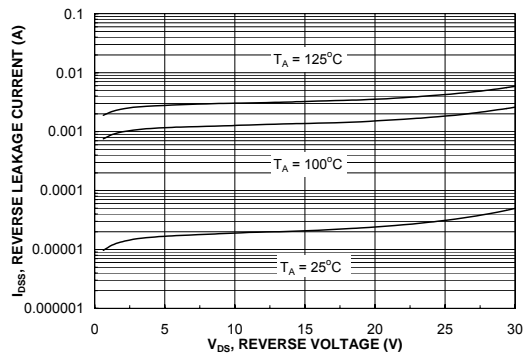

**Figure 25. SyncFET body diode reverse leakage versus drain-source voltage and temperature**

Typical Characteristics

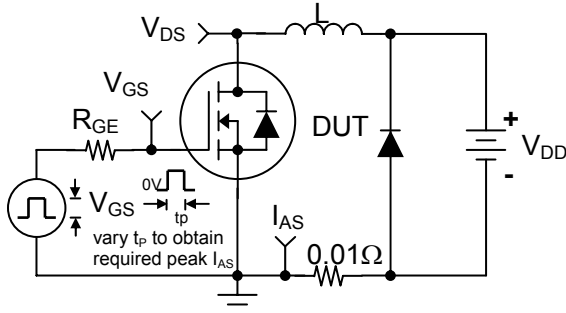

Figure 26. Unclamped Inductive Load Test Circuit

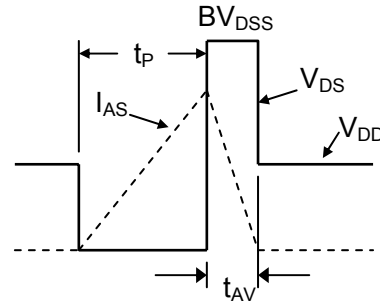

Figure 27. Unclamped Inductive Waveforms

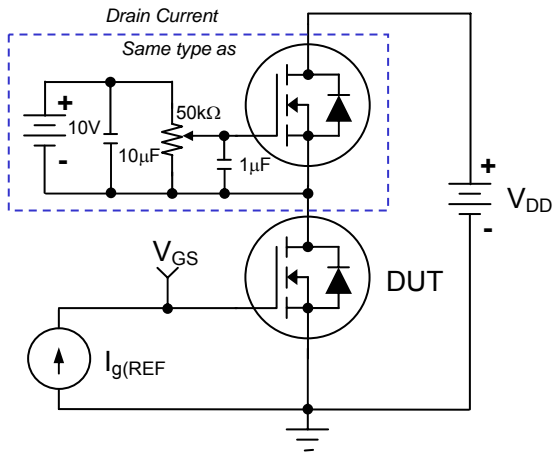

Figure 28. Gate Charge Test Circuit

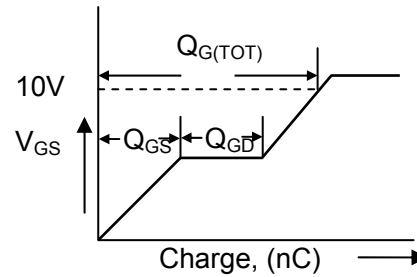

Figure 29. Gate Charge Waveform

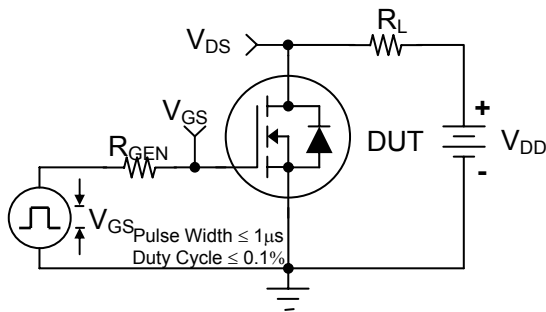

Figure 30. Switching Time Test Circuit

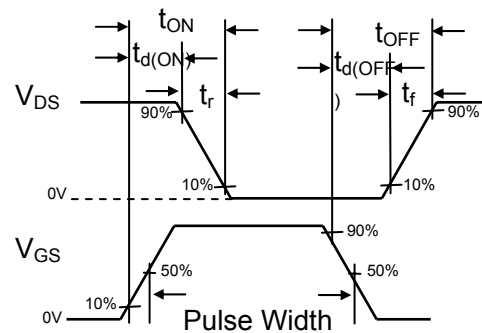





Figure 31. Switching Time Waveforms



**TRADEMARKS**

The following includes registered and unregistered trademarks and service marks, owned by Fairchild Semiconductor and/or its global subsidiaries, and is not intended to be an exhaustive list of all such trademarks.

- |   |   |   |   |
|---|---|---|---|
| ACEx®   | FPS™  | PDP-SPM™  | The Power Franchise®  |
| Build it Now™   | F-PFS™  | Power-SPM™  | <b>power</b><br>the franchise   |
| CorePLUS™   | FRFET®  | PowerTrench®  | TinyBoost™  |
| CorePOWER™  | Global Power ResourceSM   | Programmable Active Droop™  | TinyBuck™   |
| CROSSVOLT™  | Green FPS™  | QFET®   | TinyLogic®  |
| CTL™  | Green FPS™ e-Series™  | QS™   | TINYOPTO™   |
| Current Transfer Logic™   | GTO™  | Quiet Series™   | TinyPower™  |
| EcoSPARK®   | IntelliMAX™   | RapidConfigure™   | TinyPWM™  |
| EfficientMax™   | ISOPLANAR™  | Saving our world 1mW at a time™   | TinyWire™   |
| EZSWITCH™ *   | MegaBuck™   | SmartMax™   | µSerDes™  |
|  | MICROCOUPLER™   | SMART START™  |  |
|  | MicroFET™   | SPM®  | UHC®  |
| Fairchild®  | MicroPak™   | STEALTH™  | Ultra FRFET™  |
| Fairchild Semiconductor®  | MillerDrive™  | SuperFET™   | UniFET™   |
| FACT Quiet Series™  | MotionMax™  | SuperSOT™-3   | VCX™  |
| FACT®   | Motion-SPM™   | SuperSOT™-6   | VisualMax™  |
| FAST®   | OPTOLOGIC®  | SuperSOT™-8   |   |
| FastvCore™  | OPTOPLANAR®   | SuperMOS™   |   |
| FlashWriter® *  |  |  |   |

\* EZSWITCH™ and FlashWriter® are trademarks of System General Corporation, used under license by Fairchild Semiconductor.

**DISCLAIMER**

FAIRCHILD SEMICONDUCTOR RESERVES THE RIGHT TO MAKE CHANGES WITHOUT FURTHER NOTICE TO ANY PRODUCTS HEREIN TO IMPROVE RELIABILITY, FUNCTION, OR DESIGN. FAIRCHILD DOES NOT ASSUME ANY LIABILITY ARISING OUT OF THE APPLICATION OR USE OF ANY PRODUCT OR CIRCUIT DESCRIBED HEREIN; NEITHER DOES IT CONVEY ANY LICENSE UNDER ITS PATENT RIGHTS, NOR THE RIGHTS OF OTHERS. THESE SPECIFICATIONS DO NOT EXPAND THE TERMS OF FAIRCHILD'S WORLDWIDE TERMS AND CONDITIONS, SPECIFICALLY THE WARRANTY THEREIN, WHICH COVERS THESE PRODUCTS.

**LIFE SUPPORT POLICY**

FAIRCHILD'S PRODUCTS ARE NOT AUTHORIZED FOR USE AS CRITICAL COMPONENTS IN LIFE SUPPORT DEVICES OR SYSTEMS WITHOUT THE EXPRESS WRITTEN APPROVAL OF FAIRCHILD SEMICONDUCTOR CORPORATION.

As used herein:

- Life support devices or systems are devices or systems which, (a) are intended for surgical implant into the body or (b) support or sustain life, and (c) whose failure to perform when properly used in accordance with instructions for use provided in the labeling, can be reasonably expected to result in a significant injury of the user.
- A critical component in any component of a life support, device, or system whose failure to perform can be reasonably expected to cause the failure of the life support device or system, or to affect its safety or effectiveness.

**PRODUCT STATUS DEFINITIONS**

**Definition of Terms**

| Datasheet Identification | Product Status         | Definition   |
|--------------------------|------------------------|--|
| Advance Information      | Formative or In Design | This datasheet contains the design specifications for product development. Specifications may change in any manner without notice.   |
| Preliminary              | First Production       | This datasheet contains preliminary data; supplementary data will be published at a later date. Fairchild Semiconductor reserves the right to make changes at any time without notice to improve design. |
| No Identification Needed | Full Production        | This datasheet contains final specifications. Fairchild Semiconductor reserves the right to make changes at any time without notice to improve the design.   |
| Obsolete                 | Not In Production      | This datasheet contains specifications on a product that is discontinued by Fairchild Semiconductor. The datasheet is for reference information only.  |

ON Semiconductor and  are trademarks of Semiconductor Components Industries, LLC dba ON Semiconductor or its subsidiaries in the United States and/or other countries. ON Semiconductor owns the rights to a number of patents, trademarks, copyrights, trade secrets, and other intellectual property. A listing of ON Semiconductor's product/patent coverage may be accessed at [www.onsemi.com/site/pdf/Patent-Marking.pdf](http://www.onsemi.com/site/pdf/Patent-Marking.pdf). ON Semiconductor reserves the right to make changes without further notice to any products herein. ON Semiconductor makes no warranty, representation or guarantee regarding the suitability of its products for any particular purpose, nor does ON Semiconductor assume any liability arising out of the application or use of any product or circuit, and specifically disclaims any and all liability, including without limitation special, consequential or incidental damages. Buyer is responsible for its products and applications using ON Semiconductor products, including compliance with all laws, regulations and safety requirements or standards, regardless of any support or applications information provided by ON Semiconductor. "Typical" parameters which may be provided in ON Semiconductor data sheets and/or specifications can and do vary in different applications and actual performance may vary over time. All operating parameters, including "Typicals" must be validated for each customer application by customer's technical experts. ON Semiconductor does not convey any license under its patent rights nor the rights of others. ON Semiconductor products are not designed, intended, or authorized for use as a critical component in life support systems or any FDA Class 3 medical devices or medical devices with a same or similar classification in a foreign jurisdiction or any devices intended for implantation in the human body. Should Buyer purchase or use ON Semiconductor products for any such unintended or unauthorized application, Buyer shall indemnify and hold ON Semiconductor and its officers, employees, subsidiaries, affiliates, and distributors harmless against all claims, costs, damages, and expenses, and reasonable attorney fees arising out of, directly or indirectly, any claim of personal injury or death associated with such unintended or unauthorized use, even if such claim alleges that ON Semiconductor was negligent regarding the design or manufacture of the part. ON Semiconductor is an Equal Opportunity/Affirmative Action Employer. This literature is subject to all applicable copyright laws and is not for resale in any manner.

## PUBLICATION ORDERING INFORMATION

### LITERATURE FULFILLMENT:

Literature Distribution Center for ON Semiconductor  
19521 E. 32nd Pkwy, Aurora, Colorado 80011 USA  
**Phone:** 303-675-2175 or 800-344-3860 Toll Free USA/Canada  
**Fax:** 303-675-2176 or 800-344-3867 Toll Free USA/Canada  
**Email:** [orderlit@onsemi.com](mailto:orderlit@onsemi.com)

**N. American Technical Support:** 800-282-9855 Toll Free  
USA/Canada  
**Europe, Middle East and Africa Technical Support:**  
Phone: 421 33 790 2910  
**Japan Customer Focus Center**  
Phone: 81-3-5817-1050

**ON Semiconductor Website:** [www.onsemi.com](http://www.onsemi.com)  
**Order Literature:** <http://www.onsemi.com/orderlit>  
For additional information, please contact your local  
Sales Representative