

High Voltage High Side & Low Side Gate Drive IC

General description

The IR2110S is a high voltage, high speed power MOSFET and IGBT driver with independent high and low side referenced output channels based on P_SUB P_EPI process. The floating channel can be used to drive an N-channel power MOSFET or IGBT in the high side configuration which operates up to 600 V. Logic inputs are compatible with standard CMOS or LSTTL output, down to 3V logic. The output drivers feature a high pulse current buffer stage designed for minimum driver cross-conduction. Propagation delays are matched to simplify use in high frequency applications.

Application

- DC/DC Converter
- Power MOSFET or IGBT driver
- DC/AC Converter

Features

- Fully operational to +600 V
- 3.3 V / 5 V / 15 V logic compatible
- Floating channel designed for bootstrap operation
- Gate drive supply range from 10 V to 20 V
- UVLO for both channels
- 2.5A Output Current Capability
- Matched propagation delay for both channels

Package/Order Information

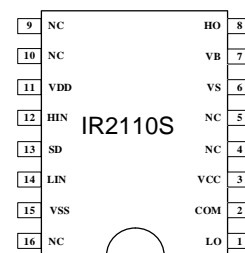

Order code	Package
IR2110STRPBF	SOW16

Typical Application Circuit

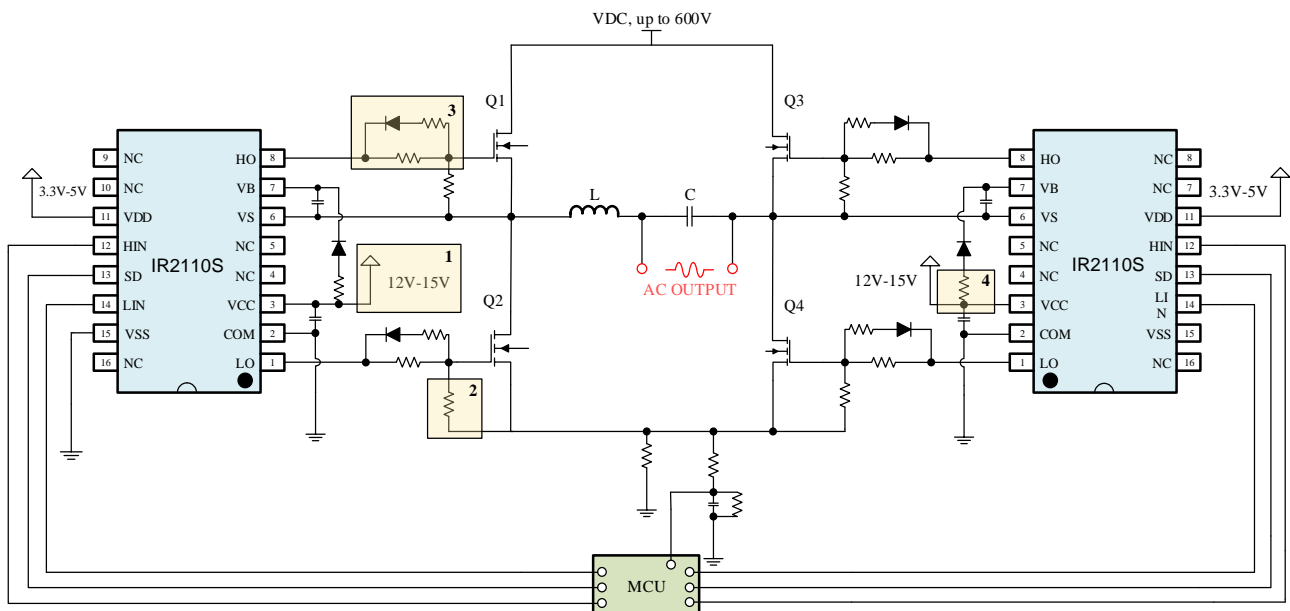

Note:

1. Vcc supply voltage, for IGBTs, should be 15V, for MOSFETs, should be 12V-15V.
2. Pull down resistor between Gate and Source of power device, the value is 10k ohms.
3. Driver circuit, turn on and turn off channel should be independently, the resistors value according to power device.
4. The resistor between Vcc and bootstrap diode, to avoid VBS dv/dt.

Pin Definitions

Pin Number	Pin Name	Pin Function Description
1	LO	Low side gate drive output, in phase with LIN
2	COM	Low side return
3	V _{CC}	Low side supply
6	V _S	High side floating supply return
7	V _B	High side floating supply
8	HO	High side gate drive output, in phase with HIN
11	V _{DD}	Logic supply
12	HIN	Logic input for high side gate driver output (HO) , in phase
13	SD	Logic input for shutdown
14	LIN	Logic input for low side gate driver output (LO), in phase
15	V _{SS}	Logic ground
16	NC	Not Connected

Functional Block Diagram

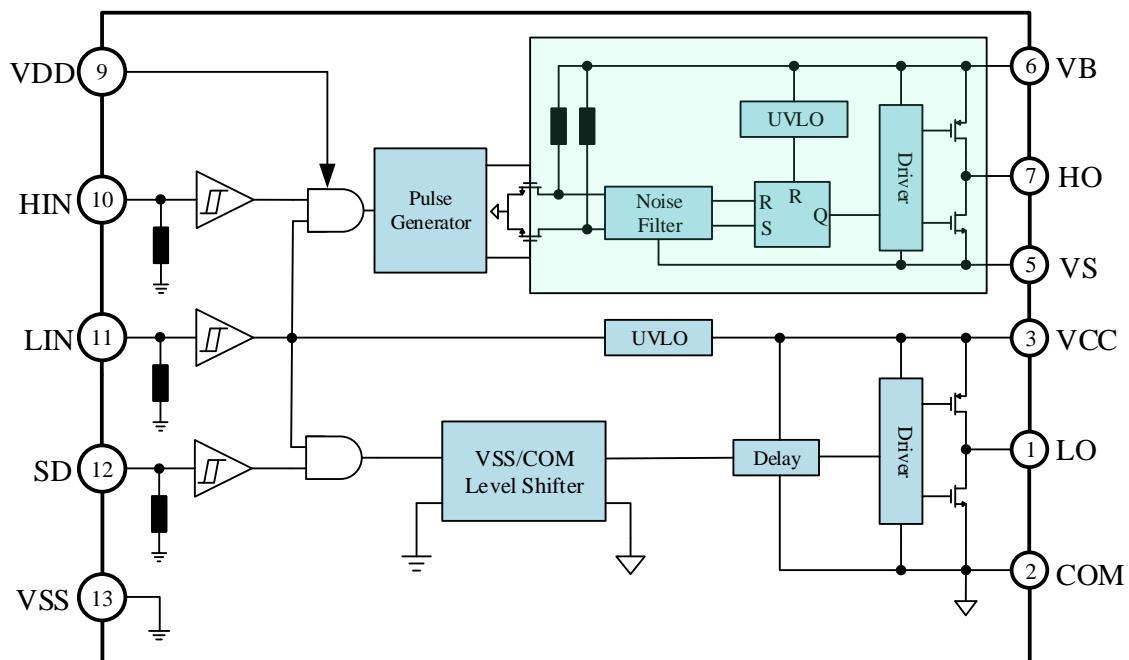

Absolute Maximum Ratings

Exceeding these ratings may damage the device.

The absolute maximum ratings are stress ratings only at $T_A=25\text{ }^\circ\text{C}$, unless otherwise specified.

Symbol	Definition	MIN.	MAX.	Units
V_B	High side floating supply	-0.3	625	V
V_S	High side floating supply return	$V_B - 25$	$V_B + 0.3$	
V_{HO}	High side gate drive output	$V_S - 0.3$	$V_B + 0.3$	
V_{CC}	Low side supply	-0.3	25	
V_{LO}	Low side gate drive output	-0.3	$V_{CC} + 0.3$	
V_{DD}	Logic supply	-0.3	$V_{CC} + 0.3$	
V_{SS}	Logic ground	$V_{CC} - 25$	$V_{CC} + 0.3$	
V_{IN}	Logic input	$V_{SS} - 0.3$	$V_{DD} + 0.3$	
dVs/dt	Allowable Offset Supply Voltage Transient	--	50	V/ns
ESD	HBM Model	2.5	--	kV
	Machine Model	200	--	V
PD	Package Power Dissipation @ $T_A \leq 25^\circ\text{C}$ (14 Lead DIP)	--	1.6	W
	Package Power Dissipation @ $T_A \leq 25^\circ\text{C}$ (16 Lead SOW)	--	1.25	
R_{thJA}	Thermal Resistance Junction to Ambient (14 Lead DIP)	--	75	$^\circ\text{C}/\text{W}$
	Thermal Resistance Junction to Ambient (16 Lead SOW)	--	100	
T_J	Junction Temperature	--	150	$^\circ\text{C}$
T_S	Storage Temperature	-55	150	
T_L	Lead Temperature (Soldering, 10 seconds)	--	300	

Recommended Operating Conditions

Symbol	Definition	Min.	Max.	Units
V_B	High side floating supply	$V_S + 10$	$V_S + 20$	V
V_S	High side floating supply return	COM - 8	600	
V_{HO}	High side gate drive output voltage	V_S	V_B	
V_{CC}	Low side supply	10	20	
V_{LO}	Low side gate drive output voltage	0	V_{CC}	
V_{DD}	Logic supply	$V_{SS} + 3$	$V_{SS} + 20$	
V_{SS}	Logic ground	-5	5	
V_{IN}	Logic input voltage (HIN & LIN & SD)	0	V_{DD}	
T_A	Ambient temperature	-40	125	$^\circ\text{C}$

Dynamic Electrical Characteristics

(V_{BIAS} (V_{CC} , V_{BS}) = 15V, C_L = 1000 pF and T_A = 25 °C unless otherwise specified.)

Symbol	Definition	TYP.	MAX.	Units
t_{on}	Turn-on propagation delay	135	220	ns
t_{off}	Turn-off propagation delay	135	220	
t_{sd}	Shutdown propagation delay	135	220	
MT	Delay matching	-	30	
t_r	Turn-on rise time	20	30	
t_f	Turn-off fall time	15	25	

Static Electrical Characteristics

(V_{BIAS} (V_{CC} , V_{BS} , V_{DD}) = 15V, C_L = 1000 pF, T_A = 25 °C and V_{SS} =COM unless otherwise specified.)

Symbol	Definition	MIN.	TYP.	MAX.	Units
V_{IH}	Logic "1" (HIN & LIN) input voltage	9.5	-	-	V
V_{IL}	Logic "0" (HIN & LIN) input voltage	-	-	5	
V_{OH}	High level output voltage, $V_{BIAS} - V_O$	-	-	1.4	
V_{OL}	Low level output voltage, V_O	-	-	0.15	
I_{QDD}	Quiescent V_{DD} supply current	-	-	30	μ A
I_{QCC}	Quiescent V_{CC} supply current	-	120	240	
I_{QBS}	Quiescent V_B supply current	-	75	150	
I_{LK}	Leakage current from $V_S(600V)$ to GND	-	-	10	
I_{IN+}	Logic "1" input bias current	-	20	40	
I_{IN-}	Logic "0" input bias current	-	-	5	
V_{BSU+}	V_{BS} supply UVLO threshold	7.5	8.4	9.7	V
V_{BSU-}		7	8	9.4	
V_{CCU+}	V_{CC} supply UVLO threshold	7.5	8.4	9.6	
V_{CCU-}		7	8	9.4	
I_{O+}	Output high short circuit pulsed current	-	2.5	-	A
I_{O-}	Output low short circuit pulsed current	-	2.5	-	

Function Timing Diagram

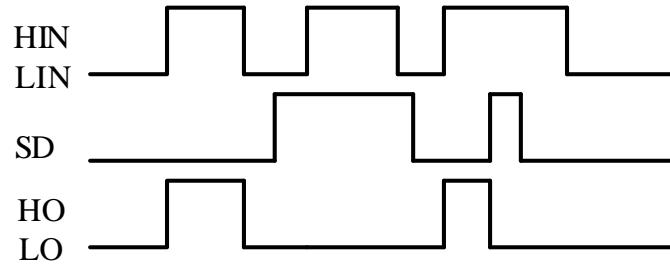

Fig.1 Input & Output

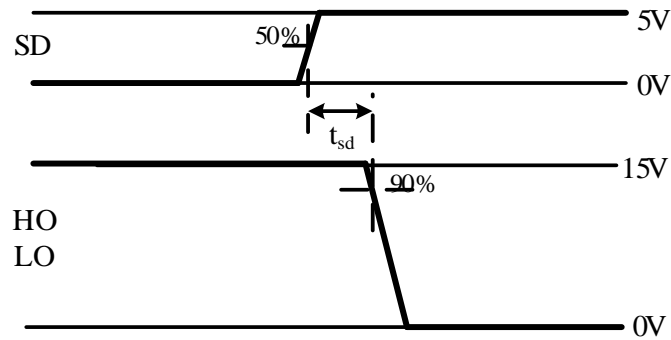

Fig.2 SD Delay Time

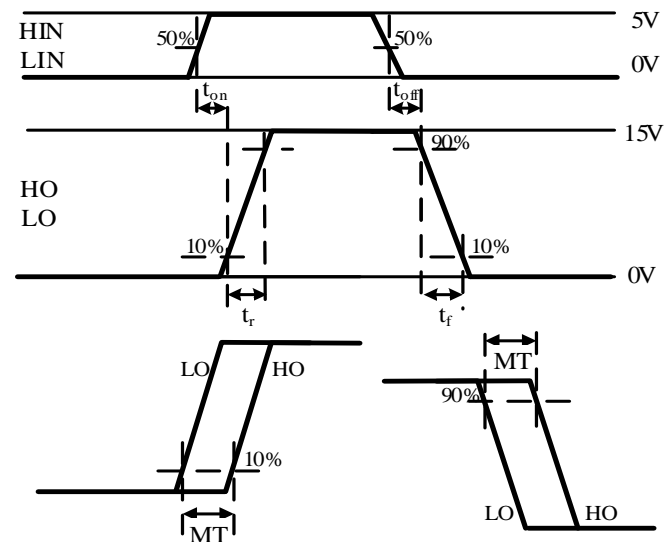
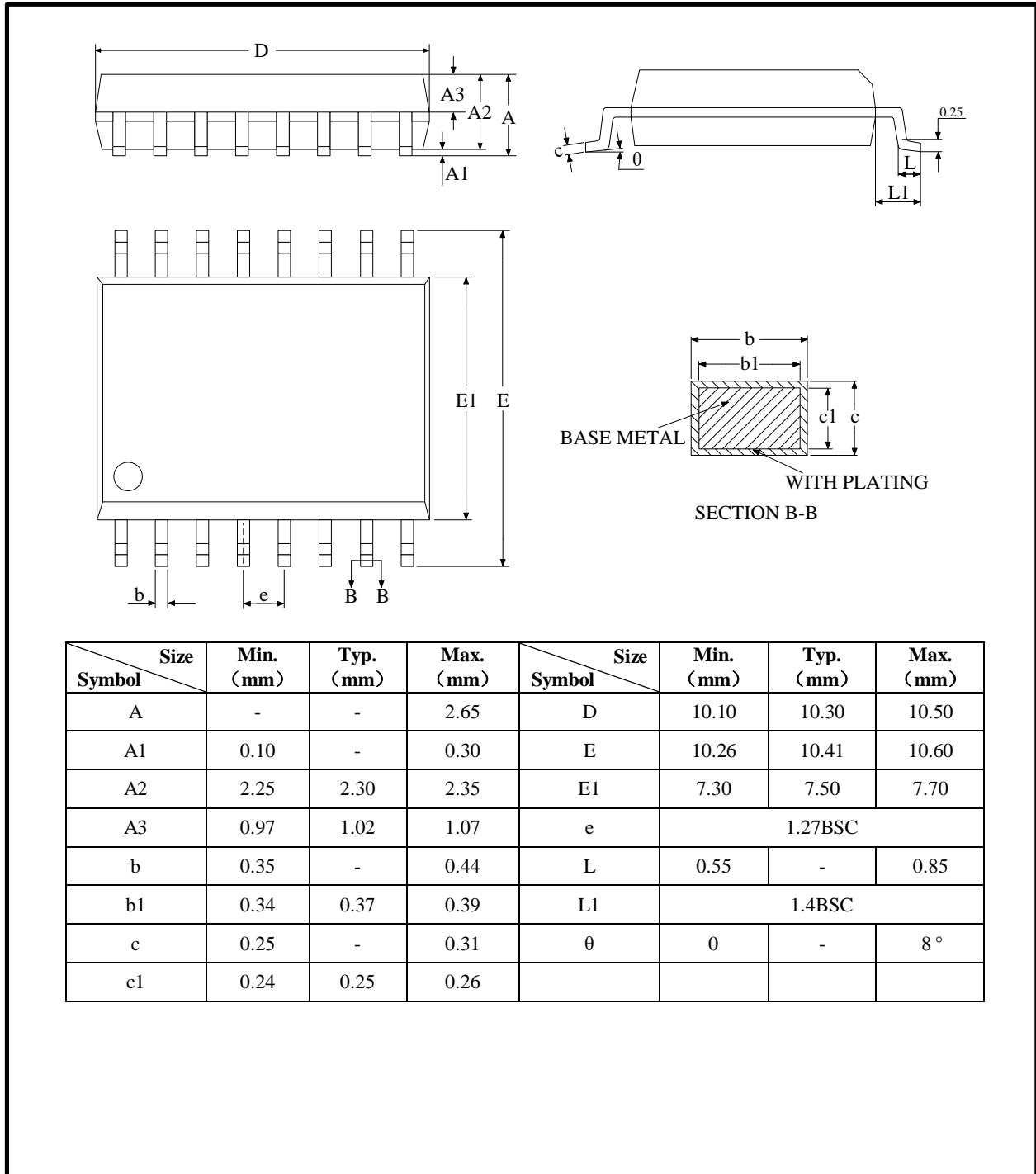

Fig.3 Turn on and Turn off Delay

Package Information

Package Information SOW16



Notes:

1. This drawing is subjected to change without notice.
2. Body dimensions do not include mold flash or protrusion.