



FEATURES

Enhanced product features

- Supports defense and aerospace applications (AQEC)
- Military temperature range (-55°C to $+125^{\circ}\text{C}$)
- Controlled manufacturing baseline
- One assembly/test site
- One fabrication site
- Enhanced product change notification
- Qualification data available on request

4 buffered 12-Bit DACs in 10-lead MSOP

- S Version: ± 10 LSB INL
- Low power operation: 500 μA @ 3 V, 600 μA @ 5 V
- 2.5 V to 5.5 V power supply
- Guaranteed monotonic by design over all codes
- Power-down to 80 nA @ 3 V, 200 nA @ 5 V
- Double-buffered input logic
- Output range: 0 V to V_{REF}
- Power-on reset to 0 V
- Simultaneous update of outputs (LDAC function)
- On-chip, rail-to-rail output buffer amplifiers
- Temperature range -55°C to $+125^{\circ}\text{C}$

APPLICATIONS

- Portable battery-powered instruments
- Digital gain and offset adjustment
- Programmable voltage and current sources
- Programmable attenuators
- Industrial process control

GENERAL DESCRIPTION

The AD5324-EP¹ is a quad 12-bit buffered voltage output DAC in a 10-lead MSOP package that operates from a single 2.5 V to 5.5 V supply, consuming 500 μA at 3 V. Its on-chip output amplifiers allows rail-to-rail output swing to be achieved with a slew rate of 0.7 V/ μs . A 3-wire serial interface is used; it operates at clock rates up to 30 MHz and is compatible with standard SPI, QSPI™, MICROWIRE™, and DSP interface standards.

The references for the four DACs are derived from one reference pin. The outputs of all DACs can be updated simultaneously using the software LDAC function. The part incorporates a power-on reset circuit, and ensures that the DAC outputs power up to 0 V and remains there until a valid write takes place to the device. The part contains a power-down feature that reduces the current consumption of the device to 200 nA at 5 V (80 nA at 3 V).

The low power consumption of this part in normal operation makes it ideally suited to portable battery-operated equipment. The power consumption is 3 mW at 5 V, and 1.5 mW at 3 V, reducing to 1 μW in power-down mode.

Full details about this enhanced product are available in the [AD5324](#) data sheet, which should be consulted in conjunction with this data sheet.

¹ Protected by U.S. Patent No. 5,969,657; other patents pending.

FUNCTIONAL BLOCK DIAGRAM

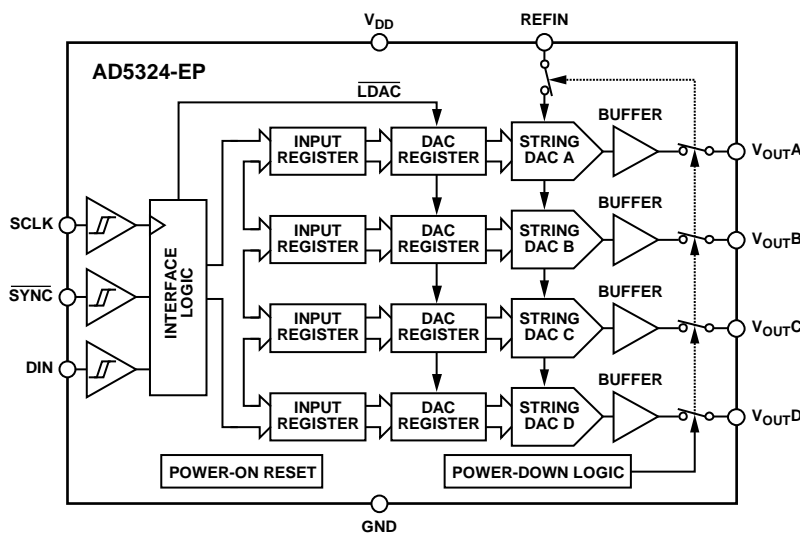

Figure 1.

Rev. 0

Information furnished by Analog Devices is believed to be accurate and reliable. However, no responsibility is assumed by Analog Devices for its use, nor for any infringements of patents or other rights of third parties that may result from its use. Specifications subject to change without notice. No license is granted by implication or otherwise under any patent or patent rights of Analog Devices. Trademarks and registered trademarks are the property of their respective owners.

TABLE OF CONTENTS

Features	1	Timing Characteristics	5
Applications.....	1	Absolute Maximum Ratings	6
General Description	1	ESD Caution.....	6
Functional Block Diagram	1	Pin Configuration and Function Descriptions.....	7
Revision History	2	Typical Performance Characteristics	8
Specifications.....	3	Outline Dimensions	11
AC Characteristics.....	4	Ordering Guide	11

REVISION HISTORY

4/10—Revision 0: Initial Version

SPECIFICATIONS

$V_{DD} = 2.5\text{ V to }5.5\text{ V}$; $V_{REF} = 2\text{ V}$; $R_L = 2\text{ k}\Omega$ to GND; $C_L = 200\text{ pF}$ to GND; all specifications T_{MIN} to T_{MAX} , unless otherwise noted.

Table 1.

Parameter	S Version			Unit	Conditions/Comments
	Min	Typ	Max		
DC PERFORMANCE¹					
Resolution		12		Bits	
Relative Accuracy		± 2	± 10	LSB	
Differential Nonlinearity ²		± 0.2	± 1	LSB	Guaranteed monotonic by design over all codes
Offset Error		± 0.4	± 3	% of FSR	See Figure 2
Gain Error		± 0.15	± 1	% of FSR	See Figure 2
Lower Dead Band		20	60	mV	Lower dead band exists only if offset error is negative
Offset Error Drift ³		-12		ppm of FSR/ $^{\circ}\text{C}$	
Gain Error Drift ³		-5		ppm of FSR/ $^{\circ}\text{C}$	
DC Power Supply Rejection Ratio ³		-60		dB	$\Delta V_{DD} = \pm 10\%$
DC Crosstalk ³		200		μV	$R_L = 2\text{ k}\Omega$ to GND or V_{DD}
DAC REFERENCE INPUTS³					
V_{REF} Input Range	0.25		V_{DD}	V	
V_{REF} Input Impedance	37	45		k Ω	Normal operation
		>10		M Ω	Power-down mode
Reference Feedthrough		-90		dB	Frequency = 10 kHz
OUTPUT CHARACTERISTICS³					
Minimum Output Voltage ⁴		0.001		V	Measurement of the minimum and maximum
Maximum Output Voltage ⁴		$V_{DD} - 0.001$			V drive capability of the output amplifier
DC Output Impedance		0.5		Ω	
Short Circuit Current		25		mA	$V_{DD} = 5\text{ V}$
		16		mA	$V_{DD} = 3\text{ V}$
Power-Up Time		2.5		μs	Coming out of power-down mode $V_{DD} = 5\text{ V}$
		5		μs	Coming out of power-down mode $V_{DD} = 3\text{ V}$
LOGIC INPUTS³					
Input Current			± 1	μA	
V_{IL} Input Low Voltage			0.8	V	$V_{DD} = 5\text{ V} \pm 10\%$
			0.6	V	$V_{DD} = 3\text{ V} \pm 10\%$
			0.5	V	$V_{DD} = 2.5\text{ V}$
V_{IH} Input High Voltage	2.4			V	$V_{DD} = 5\text{ V} \pm 10\%$
	2.1			V	$V_{DD} = 3\text{ V} \pm 10\%$
	2.0			V	$V_{DD} = 2.5\text{ V}$
Pin Capacitance		3		pF	
POWER REQUIREMENTS					
V_{DD}	2.5		5.5	V	
I_{DD} (Normal Mode) ⁵		600	900	μA	$V_{IH} = V_{DD}$ and $V_{IL} = \text{GND}$
		500	700	μA	$V_{IH} = V_{DD}$ and $V_{IL} = \text{GND}$
I_{DD} (Power-Down Mode)		0.2	1	μA	$V_{IH} = V_{DD}$ and $V_{IL} = \text{GND}$
		0.08	1	μA	$V_{IH} = V_{DD}$ and $V_{IL} = \text{GND}$

¹ DC specifications tested with the outputs unloaded.

² Linearity is tested using a reduced code range: Code 115 to Code 3981.

³ Guaranteed by design and characterization, not production tested.

⁴ For the amplifier output to reach its minimum voltage, offset error must be negative. For the amplifier output to reach its maximum voltage, $V_{REF} = V_{DD}$ and offset plus gain error must be positive.

⁵ I_{DD} specification is valid for all DAC codes; interface inactive; all DACs active; load currents excluded.

AD5324-EP

AC CHARACTERISTICS

$V_{DD} = 2.5\text{ V to }5.5\text{ V}$; $R_L = 2\text{ k}\Omega\text{ to GND}$; $C_L = 200\text{ pF to GND}$; all specifications T_{MIN} to T_{MAX} , unless otherwise noted.

Table 2.

Parameter ¹	S Version ²			Unit	Conditions/Comments
	Min	Typ	Max		
Output Voltage Settling Time		8	10	μs	$V_{REF} = V_{DD} = 5\text{ V}$ $\frac{1}{4}$ scale to $\frac{3}{4}$ scale change (0x400 to 0xC00)
Slew Rate		0.7		$\text{V}/\mu\text{s}$	
Major-Code Transition Glitch Energy		12		$\text{nV}\cdot\text{sec}$	1 LSB change around major carry
Digital Feedthrough		1		$\text{nV}\cdot\text{sec}$	
Digital Crosstalk		1		$\text{nV}\cdot\text{sec}$	
DAC-to-DAC Crosstalk		3		$\text{nV}\cdot\text{sec}$	
Multiplying Bandwidth		200		kHz	$V_{REF} = 2\text{ V} \pm 0.1\text{ V p-p}$
Total Harmonic Distortion		-70		dB	$V_{REF} = 2.5\text{ V} \pm 0.1\text{ V p-p}$; frequency = 10 kHz

¹ Guaranteed by design and characterization, not production tested.

² Temperature range (S Version): -55°C to $+125^\circ\text{C}$; typical at $+25^\circ\text{C}$.

TIMING CHARACTERISTICS

$V_{DD} = 2.5\text{ V to }5.5\text{ V}$; all specifications T_{MIN} to T_{MAX} , unless otherwise noted.

Table 3.

Parameter ^{1, 2, 3}	Limit at T_{MIN} / T_{MAX}		Unit	Conditions/Comments
	$V_{DD} = 2.5\text{ V to }3.6\text{ V}$	$V_{DD} = 3.6\text{ V to }5.5\text{ V}$		
t_1	40	33	ns min	SCLK cycle time
t_2	16	13	ns min	SCLK high time
t_3	16	13	ns min	SCLK low time
t_4	16	13	ns min	$\overline{\text{SYNC}}$ to SCLK falling edge setup time
t_5	5	5	ns min	Data setup time
t_6	4.5	4.5	ns min	Data hold time
t_7	0	0	ns min	SCLK falling edge to $\overline{\text{SYNC}}$ rising edge
t_8	80	33	ns min	Minimum $\overline{\text{SYNC}}$ high time

¹ Guaranteed by design and characterization, not production tested.

² All input signals are specified with $t_r = t_f = 5\text{ ns}$ (10% to 90% of V_{DD}) and timed from a voltage level of $(V_{IL} + V_{IH})/2$.

³ See Figure 2.

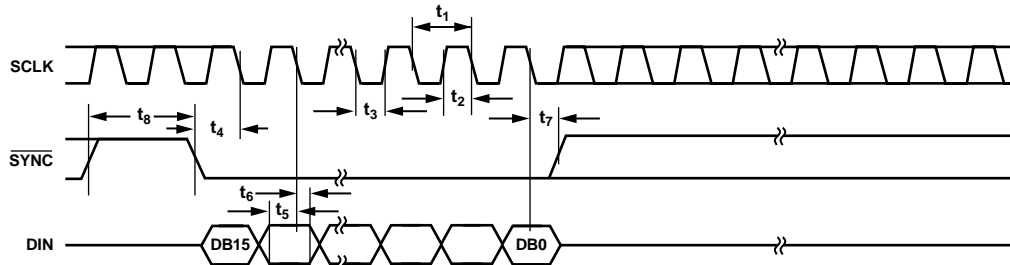

Figure 2. Serial Interface Timing Diagram

00925-002

ABSOLUTE MAXIMUM RATINGS

$T_A = 25^\circ\text{C}$, unless otherwise noted.

Table 4.

Parameter ¹	Rating
V_{DD} to GND	-0.3 V to +7 V
Digital Input Voltage to GND	-0.3 V to $V_{DD} + 0.3$ V
Reference Input Voltage to GND	-0.3 V to $V_{DD} + 0.3$ V
V_{OUTA} through V_{OUTD} to GND	-0.3 V to $V_{DD} + 0.3$ V
Operating Temperature Range	
Industrial (EP Version)	-55°C to +125°C
Storage Temperature Range	-65°C to +150°C
Junction Temperature (T_J max)	150°C
10-Lead MSOP	
Power Dissipation	$(T_J \text{ max} - T_A) / \theta_{JA}$
θ_{JA} Thermal Impedance	206°C/W
θ_{JC} Thermal Impedance	44°C/W
Reflow Soldering	
Peak Temperature	220°C
Time at Peak Temperature	10 sec to 40 sec

¹ Transient currents of up to 100 mA do not cause SCR latch-up.

Stresses above those listed under Absolute Maximum Ratings may cause permanent damage to the device. This is a stress rating only; functional operation of the device at these or any other conditions above those indicated in the operational section of this specification is not implied. Exposure to absolute maximum rating conditions for extended periods may affect device reliability.

ESD CAUTION



ESD (electrostatic discharge) sensitive device. Charged devices and circuit boards can discharge without detection. Although this product features patented or proprietary protection circuitry, damage may occur on devices subjected to high energy ESD. Therefore, proper ESD precautions should be taken to avoid performance degradation or loss of functionality.

PIN CONFIGURATION AND FUNCTION DESCRIPTIONS

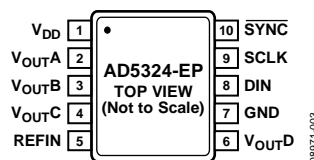

Figure 3. MSOP Pin Configuration

Table 5. Pin Function Descriptions

Pin No.	Mnemonic	Description
1	V_{DD}	Power Supply Input. This part can be operated from 2.5 V to 5.5 V and the supply can be decoupled to GND.
2	V_{OUTA}	Buffered Analog Output Voltage from DAC A. The output amplifier has rail-to-rail operation.
3	V_{OUTB}	Buffered Analog Output Voltage from DAC B. The output amplifier has rail-to-rail operation.
4	V_{OUTC}	Buffered Analog Output Voltage from DAC C. The output amplifier has rail-to-rail operation.
5	REFIN	Reference Input Pin for All Four DACs. It has an input range from 0.25 V to V_{DD} .
6	V_{OUTD}	Buffered Analog Output Voltage from DAC D. The output amplifier has rail-to-rail operation.
7	GND	Ground Reference Point for All Circuitry on the Part.
8	DIN	Serial Data Input. This device has a 16-bit shift register. Data is clocked into the register on the falling edge of the serial clock input. The DIN input buffer is powered down after each write cycle.
9	SCLK	Serial Clock Input. Data is clocked into the input shift register on the falling edge of the serial clock input. Data can be transferred at clock speeds up to 30 MHz. The SCLK input buffer is powered down after each write cycle.
10	$\overline{\text{SYNC}}$	Active Low Control Input. This is the frame synchronization signal for the input data. When $\overline{\text{SYNC}}$ goes low, it enables the input shift register and data is transferred in on the falling edges of the following 16 clocks. If $\overline{\text{SYNC}}$ is taken high before the 16 th falling edge of SCLK, the rising edge of $\overline{\text{SYNC}}$ acts as an interrupt and the write sequence is ignored by the device.

TYPICAL PERFORMANCE CHARACTERISTICS

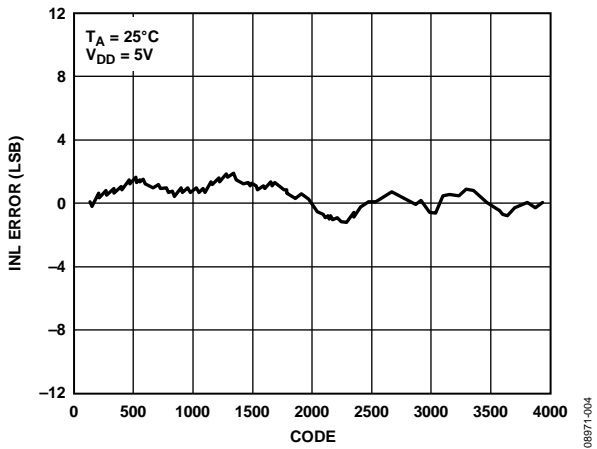

Figure 4. Typical INL Plot

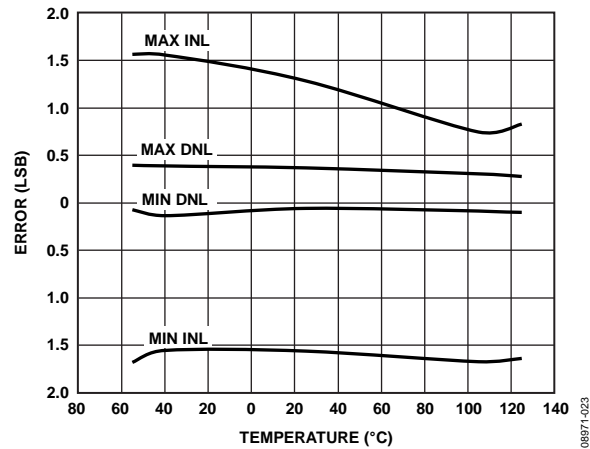

Figure 7. INL and DNL Error vs. Temperature

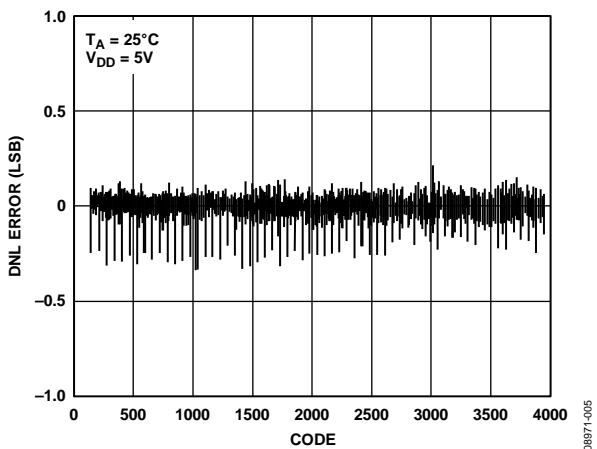

Figure 5. Typical DNL Plot

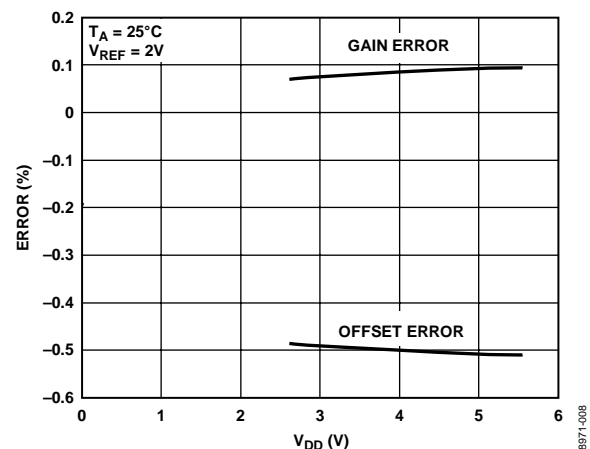

Figure 8. Offset Error and Gain Error vs. V_{DD}

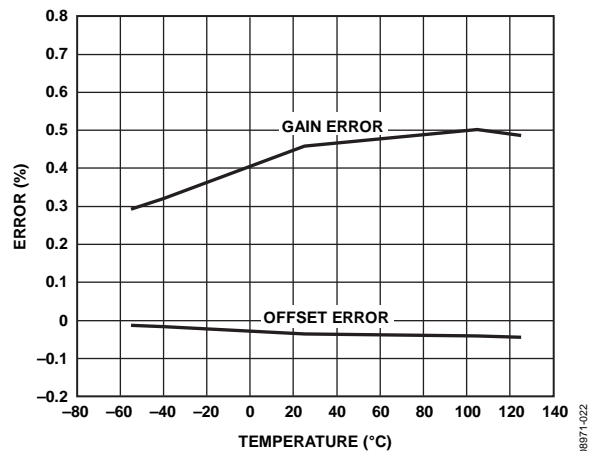

Figure 6. Offset Error and Gain Error vs. Temperature

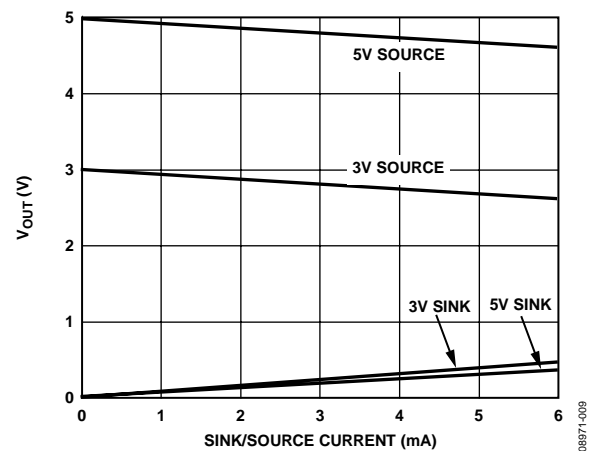

Figure 9. V_{OUT} Source and Sink Current Capability

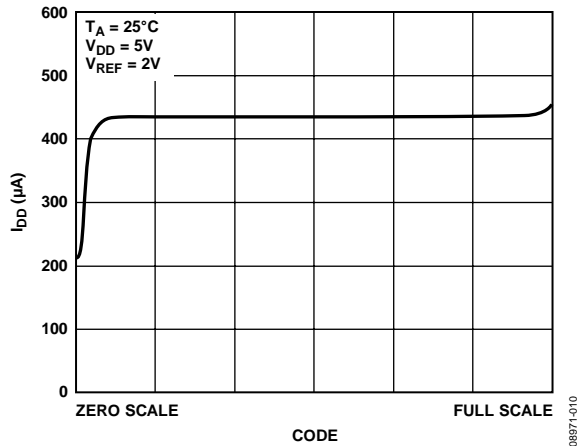

Figure 10. Supply Current vs. DAC Code

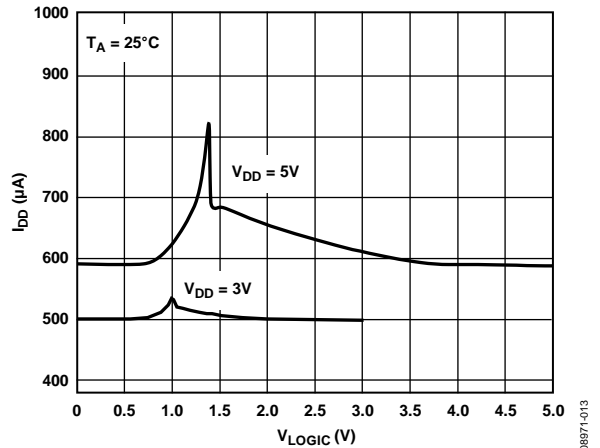

Figure 13. Supply Current vs. Logic Input Voltage

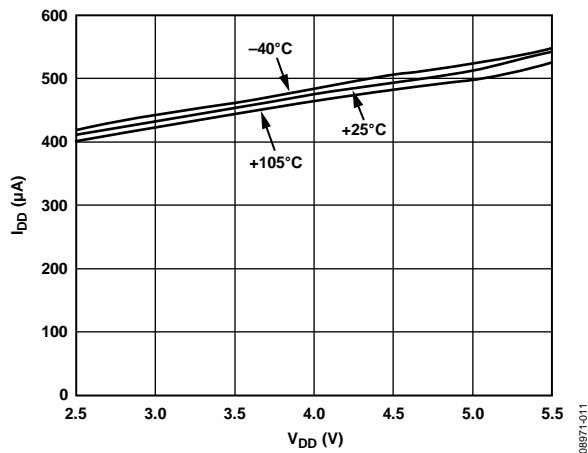

Figure 11. Supply Current vs. Supply Voltage

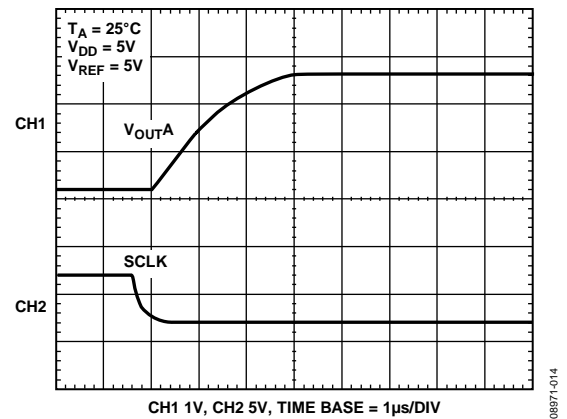

Figure 14. Half-Scale Settling ($1/4$ to $3/4$ Scale Code Change)

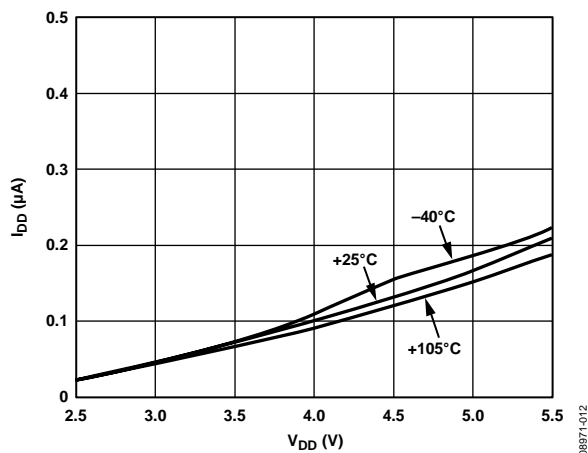

Figure 12. Power-Down Current vs. Supply Voltage

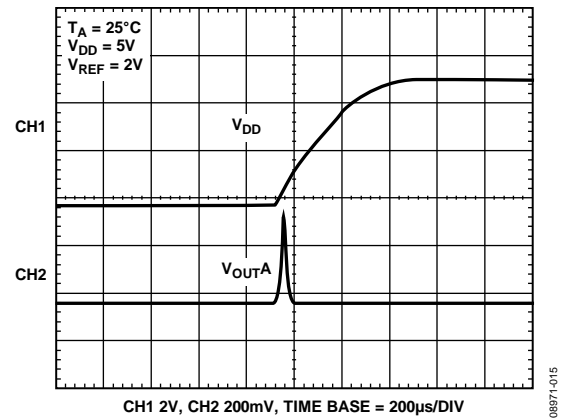

Figure 15. Power-On Reset to 0V

AD5324-EP

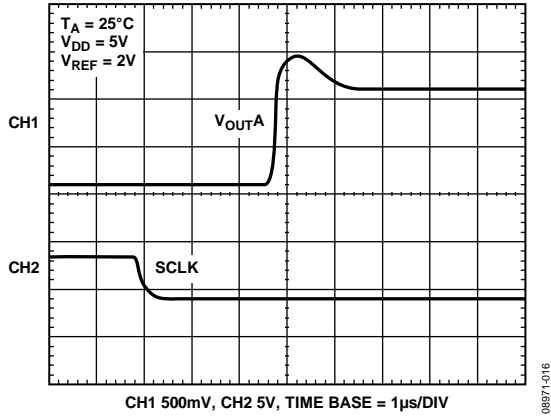

Figure 16. Exiting Power-Down to Midscale

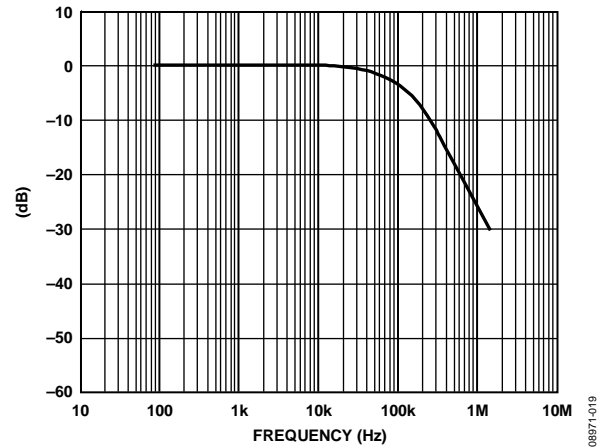

Figure 19. Multiplying Bandwidth (Small-Signal Frequency Response)

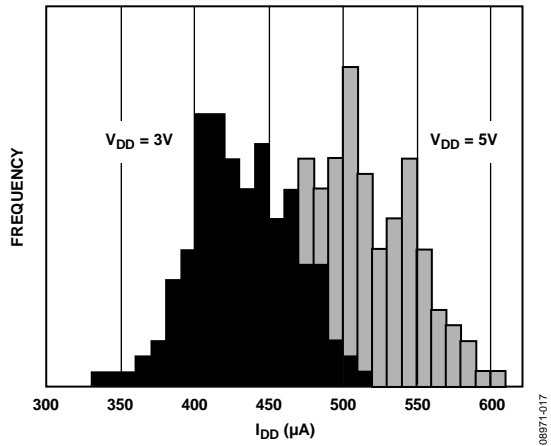

Figure 17. I_{DD} Histogram with $V_{DD} = 3\text{V}$ and $V_{DD} = 5\text{V}$

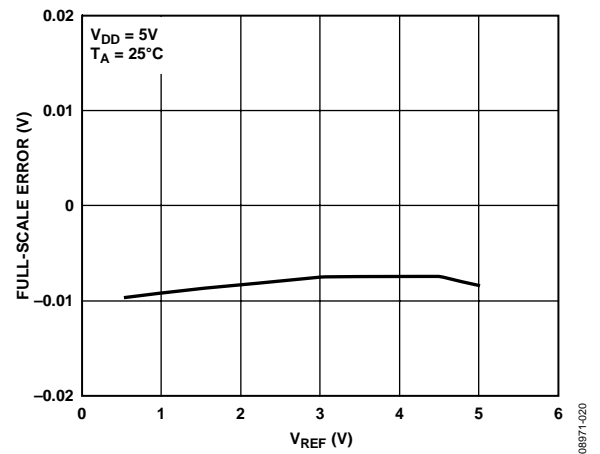

Figure 20. Full-Scale Error vs. V_{REF}

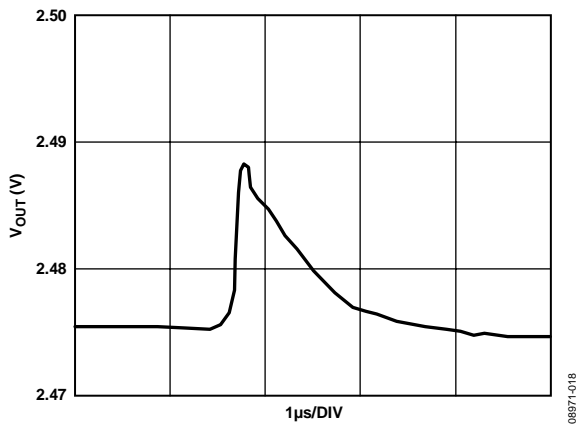

Figure 18. Major-Code Transition Glitch Energy

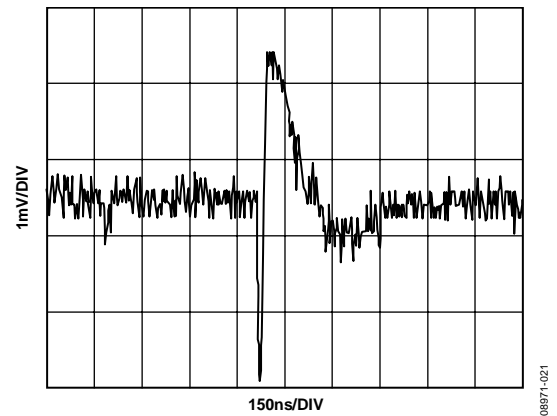
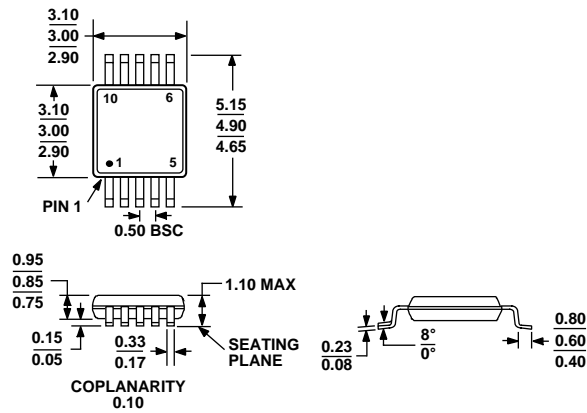

Figure 21. DAC-to-DAC Crosstalk

OUTLINE DIMENSIONS



COMPLIANT TO JEDEC STANDARDS MO-187-BA

Figure 22. 10-Lead Mini Small Outline Package [MSOP] (RM-10)

Dimensions shown in millimeters

ORDERING GUIDE

Model ¹	Temperature Range	Package Description	Package Option	Branding
AD5324SRMZ-EP-RL7	-55°C to +125°C	10-Lead Mini Small Outline Package (MSOP)	RM-10	DFT

¹ Z = RoHS Compliant Part.

AD5324-EP

NOTES

Mouser Electronics

Authorized Distributor

Click to View Pricing, Inventory, Delivery & Lifecycle Information:

[Analog Devices Inc.:](#)

[AD5324ACPZ-REEL7](#) [AD5324BRMZ-REEL7](#) [AD5324ARMZ](#) [AD5324ARMZ-REEL7](#) [AD5324BRM-REEL7](#)
[AD5324BRMZ](#) [AD5324BRM](#) [AD5324ARM](#) [AD5324BCPZ-REEL7](#) [AD5324SRMZ-EP-RL7](#) [AD5324BRMZ-REEL](#)