

FEATURES

- Wide input range beyond supplies
- Rugged input overvoltage protection
- Low supply current: 200 μ A maximum per channel
- Low power dissipation: 0.5 mW at $V_S = 2.5$ V
- Bandwidth: 550 kHz
- CMRR: 86 dB minimum, dc to 10 kHz
- Low offset voltage drift: ± 2 μ V/ $^{\circ}$ C maximum (B Grade)
- Low gain drift: 1 ppm/ $^{\circ}$ C maximum (B Grade)
- Enhanced slew rate: 1.1 V/ μ s
- Wide power supply range:
 - Single supply: 2 V to 36 V
 - Dual supplies: ± 2 V to ± 18 V

APPLICATIONS

- Voltage measurement and monitoring
- Current measurement and monitoring
- Differential output instrumentation amplifier
- Portable, battery-powered equipment
- Test and measurement

GENERAL DESCRIPTION

The AD8276/AD8277 are general-purpose, unity-gain difference amplifiers intended for precision signal conditioning in power critical applications that require both high performance and low power. They provide exceptional common-mode rejection ratio (86 dB) and high bandwidth while amplifying signals well beyond the supply rails. The on-chip resistors are laser-trimmed for excellent gain accuracy and high CMRR. They also have extremely low gain drift vs. temperature.

The common-mode range of the amplifiers extends to almost double the supply voltage, making these amplifiers ideal for single-supply applications that require a high common-mode voltage range. The internal resistors and ESD circuitry at the inputs also provide overvoltage protection to the op amps.

The AD8276/AD8277 are unity-gain stable. While they are optimized for use as difference amplifiers, they can also be connected in high precision, single-ended configurations with $G = -1, +1, +2$. The AD8276/AD8277 provide an integrated precision solution that has smaller size, lower cost, and better performance than a discrete alternative.

The AD8276/AD8277 operate on single supplies (2.0 V to 36 V) or dual supplies (± 2 V to ± 18 V). The maximum quiescent supply current is 200 μ A per channel, which is ideal for battery-operated and portable systems.

FUNCTIONAL BLOCK DIAGRAM

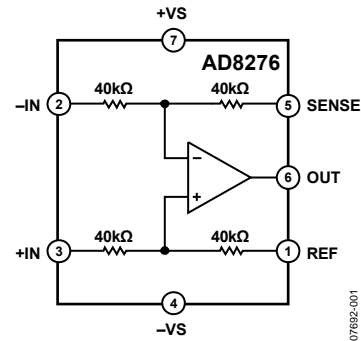

Figure 1. AD8276

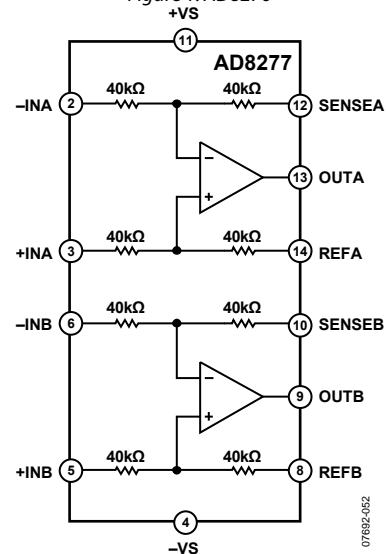

Figure 2. AD8277

Table 1. Difference Amplifiers by Category

Low Distortion	High Voltage	Current Sensing ¹	Low Power
AD8270	AD628	AD8202 (U)	AD8276
AD8271	AD629	AD8203 (U)	AD8277
AD8273		AD8205 (B)	AD8278
AD8274		AD8206 (B)	
AMP03		AD8216 (B)	

¹ U = unidirectional, B = bidirectional.

The AD8276 is available in the space-saving 8-lead MSOP and SOIC packages, and the AD8277 is offered in a 14-lead SOIC package. Both are specified for performance over the industrial temperature range of -40° C to $+85^{\circ}$ C and are fully RoHS compliant.

Rev. C

Information furnished by Analog Devices is believed to be accurate and reliable. However, no responsibility is assumed by Analog Devices for its use, nor for any infringements of patents or other rights of third parties that may result from its use. Specifications subject to change without notice. No license is granted by implication or otherwise under any patent or patent rights of Analog Devices. Trademarks and registered trademarks are the property of their respective owners.

TABLE OF CONTENTS

Features	1	Circuit Information.....	14
Applications.....	1	Driving the AD8276/AD8277	14
General Description	1	Input Voltage Range.....	14
Functional Block Diagram	1	Power Supplies.....	15
Revision History	2	Applications Information	16
Specifications.....	3	Configurations.....	16
Absolute Maximum Ratings.....	5	Differential Output	16
Thermal Resistance	5	Current Source.....	17
Maximum Power Dissipation	5	Voltage and Current Monitoring.....	17
Short-Circuit Current	5	Instrumentation Amplifier.....	18
ESD Caution.....	5	RTD	18
Pin Configurations and Function Descriptions	6	Outline Dimensions	19
Typical Performance Characteristics	8	Ordering Guide	20
Theory of Operation	14		

REVISION HISTORY

11/11—Rev. B to Rev. C

Change to Figure 53 18

4/10—Rev. A to Rev. B

Changes to Figure 53..... 18

Updated Outline Dimensions 19

7/09—Rev. 0 to Rev. A

Added AD8277 Universal

Changes to Features Section..... 1

Changes to General Description Section
 1 |

Added Figure 2; Renumbered Sequentially
 1 |

Changes to Specifications Section.....
 3 |

Changes to Figure 3 and Table 5.....
 5 |

Added Figure 5 and Table 7; Renumbered Sequentially
 7 |

Changes to Figure 10.....8

Changes to Figure 34..... 12

Added Figure 36
 13 |

Changes to Input Voltage Range Section
 14 |

Changes to Power Supplies Section and Added Figure 40.....
 15 |

Added to Figure 40.....
 15 |

Changes to Differential Output Section
 16 |

Added Figure 47 and Changes to Current Source Section
 17 |

Added Voltage and Current Monitoring Section and Figure 49.....
 17 |

Moved Instrumentation Amplifier Section and Added RTD

Section.....
 18 |

Changes to Ordering Guide
 20 |

5/09—Revision 0: Initial Version

Rev. C | Page 2 of 20

SPECIFICATIONS

$V_S = \pm 5\text{ V}$ to $\pm 15\text{ V}$, $V_{REF} = 0\text{ V}$, $T_A = 25^\circ\text{C}$, $R_L = 10\text{ k}\Omega$ connected to ground, $G = 1$ difference amplifier configuration, unless otherwise noted.

Table 2.

Parameter	Conditions	G = 1						Unit
		Grade B			Grade A			
		Min	Typ	Max	Min	Typ	Max	
INPUT CHARACTERISTICS								
System Offset ¹	$T_A = -40^\circ\text{C}$ to $+85^\circ\text{C}$		100	200		100	500	μV
vs. Temperature					200			500
Average Temperature Coefficient	$T_A = -40^\circ\text{C}$ to $+85^\circ\text{C}$		0.5	2		2	5	$\mu\text{V}/^\circ\text{C}$
vs. Power Supply	$V_S = \pm 5\text{ V}$ to $\pm 18\text{ V}$			5			10	$\mu\text{V}/\text{V}$
Common-Mode Rejection Ratio (RTI)	$V_S = \pm 15\text{ V}$, $V_{CM} = \pm 27\text{ V}$, $R_S = 0\ \Omega$	86			80			dB
Input Voltage Range ²		$-2(V_S + 0.1)$		$+2(V_S - 1.5)$	$-2(V_S + 0.1)$		$+2(V_S - 1.5)$	V
Impedance ³								
Differential			80			80		k Ω
Common Mode			40			40		k Ω
DYNAMIC PERFORMANCE								
Bandwidth				550		550		kHz
Slew Rate		0.9		1.1	0.9		1.1	V/ μs
Settling Time to 0.01%	10 V step on output, $C_L = 100\text{ pF}$							
				15			15	μs
Settling Time to 0.001%				16			16	μs
Channel Separation	$f = 1\text{ kHz}$			130			130	dB
GAIN								
Gain Error			0.005	0.02		0.01	0.05	%
Gain Drift	$T_A = -40^\circ\text{C}$ to $+85^\circ\text{C}$			1			5	ppm/ $^\circ\text{C}$
Gain Nonlinearity	$V_{OUT} = 20\text{ V p-p}$			5			10	ppm
OUTPUT CHARACTERISTICS								
Output Voltage Swing ⁴	$V_S = \pm 15\text{ V}$, $R_L = 10\text{ k}\Omega$, $T_A = -40^\circ\text{C}$ to $+85^\circ\text{C}$	$-V_S + 0.2$		$+V_S - 0.2$	$-V_S + 0.2$		$+V_S - 0.2$	V
Short-Circuit Current Limit			± 15			± 15		mA
Capacitive Load Drive			200			200		pF
NOISE⁵								
Output Voltage Noise	$f = 0.1\text{ Hz}$ to 10 Hz		2			2		$\mu\text{V p-p}$
	$f = 1\text{ kHz}$		65	70		65	70	nV/ $\sqrt{\text{Hz}}$
POWER SUPPLY								
Supply Current ⁶				200			200	μA
vs. Temperature	$T_A = -40^\circ\text{C}$ to $+85^\circ\text{C}$			250			250	μA
Operating Voltage Range ⁷		± 2		± 18	± 2		± 18	V
TEMPERATURE RANGE								
Operating Range		-40		$+125$	-40		$+125$	$^\circ\text{C}$

¹ Includes input bias and offset current errors, RTO (referred to output).

² The input voltage range may also be limited by absolute maximum input voltage or by the output swing. See the Input Voltage Range section in the Theory of Operation section for details.

³ Internal resistors are trimmed to be ratio matched and have $\pm 20\%$ absolute accuracy.

⁴ Output voltage swing varies with supply voltage and temperature. See Figure 18 through Figure 21 for details.

⁵ Includes amplifier voltage and current noise, as well as noise from internal resistors.

⁶ Supply current varies with supply voltage and temperature. See Figure 22 and Figure 24 for details.

⁷ Unbalanced dual supplies can be used, such as $-V_S = -0.5\text{ V}$ and $+V_S = +2\text{ V}$. The positive supply rail must be at least 2 V above the negative supply and reference voltage.

$V_S = +2.7\text{ V}$ to $<\pm 5\text{ V}$, $V_{REF} = \text{midsupply}$, $T_A = 25^\circ\text{C}$, $R_L = 10\text{ k}\Omega$ connected to midsupply, $G = 1$ difference amplifier configuration, unless otherwise noted.

Table 3.

Parameter	Conditions	G = 1						Unit
		Grade B			Grade A			
		Min	Typ	Max	Min	Typ	Max	
INPUT CHARACTERISTICS								
System Offset ¹	$T_A = -40^\circ\text{C}$ to $+85^\circ\text{C}$		100	200		100	500	μV
vs. Temperature					200			500
Average Temperature Coefficient	$T_A = -40^\circ\text{C}$ to $+85^\circ\text{C}$		0.5	2		2	5	$\mu\text{V}/^\circ\text{C}$
vs. Power Supply	$V_S = \pm 5\text{ V}$ to $\pm 18\text{ V}$			5			10	$\mu\text{V}/\text{V}$
Common-Mode Rejection Ratio (RTI)	$V_S = 2.7\text{ V}$, $V_{CM} = 0\text{ V}$ to 2.4 V , $R_S = 0\ \Omega$	86			80			dB
	$V_S = \pm 5\text{ V}$, $V_{CM} = -10\text{ V}$ to $+7\text{ V}$, $R_S = 0\ \Omega$	86			80			dB
Input Voltage Range ²		$-2(V_S + 0.1)$		$+2(V_S - 1.5)$	$-2(V_S + 0.1)$		$+2(V_S - 1.5)$	V
Impedance ³								
Differential			80			80		k Ω
Common Mode			40			40		k Ω
DYNAMIC PERFORMANCE								
Bandwidth			450			450		kHz
Slew Rate			1.0			1.0		V/ μs
Settling Time to 0.01%	8 V step on output, $C_L = 100\text{ pF}$, $V_S = 10\text{ V}$		5			5		μs
Channel Separation	$f = 1\text{ kHz}$		130			130		dB
GAIN								
Gain Error	$T_A = -40^\circ\text{C}$ to $+85^\circ\text{C}$		0.005	0.02		0.01	0.05	%
Gain Drift					1			5
OUTPUT CHARACTERISTICS								
Output Swing ⁴	$R_L = 10\text{ k}\Omega$, $T_A = -40^\circ\text{C}$ to $+85^\circ\text{C}$	$-V_S + 0.1$		$+V_S - 0.15$	$-V_S + 0.1$		$+V_S - 0.15$	V
Short-Circuit Current Limit			± 10			± 10		mA
Capacitive Load Drive			200			200		pF
NOISE ⁵								
Output Voltage Noise	$f = 0.1\text{ Hz}$ to 10 Hz		2			2		$\mu\text{V p-p}$
	$f = 1\text{ kHz}$		65			65		nV/ $\sqrt{\text{Hz}}$
POWER SUPPLY								
Supply Current ⁶	$T_A = -40^\circ\text{C}$ to $+85^\circ\text{C}$			200			200	μA
Operating Voltage Range		2.0		36	2.0		36	V
TEMPERATURE RANGE								
Operating Range		-40		+125	-40		+125	$^\circ\text{C}$

¹ Includes input bias and offset current errors, RTO (referred to output).

² The input voltage range may also be limited by absolute maximum input voltage or by the output swing. See the Input Voltage Range section in the Theory of Operation section for details.

³ Internal resistors are trimmed to be ratio matched and have $\pm 20\%$ absolute accuracy.

⁴ Output voltage swing varies with supply voltage and temperature. See Figure 18 through Figure 21 for details.

⁵ Includes amplifier voltage and current noise, as well as noise from internal resistors.

⁶ Supply current varies with supply voltage and temperature. See Figure 23 and Figure 24 for details.

ABSOLUTE MAXIMUM RATINGS

Table 4.

Parameter	Rating
Supply Voltage	$\pm 18\text{ V}$
Maximum Voltage at Any Input Pin	$-V_S + 40\text{ V}$
Minimum Voltage at Any Input Pin	$+V_S - 40\text{ V}$
Storage Temperature Range	-65°C to $+150^\circ\text{C}$
Specified Temperature Range	-40°C to $+85^\circ\text{C}$
Package Glass Transition Temperature (T_G)	150°C

Stresses above those listed under Absolute Maximum Ratings may cause permanent damage to the device. This is a stress rating only; functional operation of the device at these or any other conditions above those indicated in the operational section of this specification is not implied. Exposure to absolute maximum rating conditions for extended periods may affect device reliability.

THERMAL RESISTANCE

The θ_{JA} values in Table 5 assume a 4-layer JEDEC standard board with zero airflow.

Table 5.

Package Type	θ_{JA}	Unit
8-Lead MSOP	135	$^\circ\text{C}/\text{W}$
8-Lead SOIC	121	$^\circ\text{C}/\text{W}$
14-Lead SOIC	105	$^\circ\text{C}/\text{W}$

MAXIMUM POWER DISSIPATION

The maximum safe power dissipation for the AD8276/AD8277 is limited by the associated rise in junction temperature (T_J) on the die. At approximately 150°C , which is the glass transition temperature, the properties of the plastic change. Even temporarily exceeding this temperature limit may change the stresses that the package exerts on the die, permanently shifting the parametric performance of the amplifiers. Exceeding a temperature of 150°C for an extended period may result in a loss of functionality.

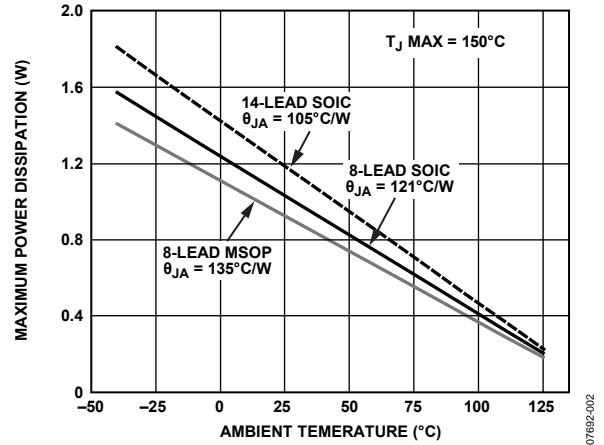

Figure 3. Maximum Power Dissipation vs. Ambient Temperature

SHORT-CIRCUIT CURRENT

The AD8276/AD8277 have built-in, short-circuit protection that limits the output current (see Figure 25 for more information). While the short-circuit condition itself does not damage the part, the heat generated by the condition can cause the part to exceed its maximum junction temperature, with corresponding negative effects on reliability. Figure 3 and Figure 25, combined with knowledge of the supply voltages and ambient temperature of the part, can be used to determine whether a short circuit will cause the part to exceed its maximum junction temperature.

ESD CAUTION



ESD (electrostatic discharge) sensitive device. Charged devices and circuit boards can discharge without detection. Although this product features patented or proprietary protection circuitry, damage may occur on devices subjected to high energy ESD. Therefore, proper ESD precautions should be taken to avoid performance degradation or loss of functionality.

PIN CONFIGURATIONS AND FUNCTION DESCRIPTIONS

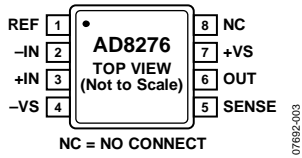

Figure 4. AD8276 8-Lead MSOP Pin Configuration

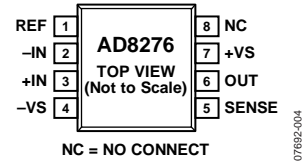

Figure 5. AD8276 8-Lead SOIC Pin Configuration

Table 6. AD8276 Pin Function Descriptions

Pin No.	Mnemonic	Description
1	REF	Reference Voltage Input.
2	-IN	Inverting Input.
3	+IN	Noninverting Input.
4	-VS	Negative Supply.
5	SENSE	Sense Terminal.
6	OUT	Output.
7	+VS	Positive Supply.
8	NC	No Connect.

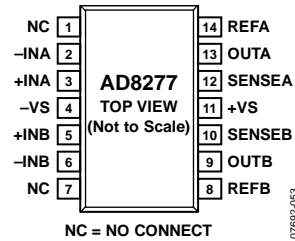

Figure 6. AD8277 14-Lead SOIC Pin Configuration

Table 7. AD8277 Pin Function Descriptions

Pin No.	Mnemonic	Description
1	NC	No Connect.
2	-INA	Channel A Inverting Input.
3	+INA	Channel A Noninverting Input.
4	-VS	Negative Supply.
5	+INB	Channel B Noninverting Input.
6	-INB	Channel B Inverting Input.
7	NC	No Connect.
8	REFB	Channel B Reference Voltage Input.
9	OUTB	Channel B Output.
10	SENSEB	Channel B Sense Terminal.
11	+VS	Positive Supply.
12	SENSEA	Channel A Sense Terminal.
13	OUTA	Channel A Output.
14	REFA	Channel A Reference Voltage Input.

TYPICAL PERFORMANCE CHARACTERISTICS

$V_S = \pm 15\text{ V}$, $T_A = 25^\circ\text{C}$, $R_L = 10\text{ k}\Omega$ connected to ground, $G = 1$ difference amplifier configuration, unless otherwise noted.

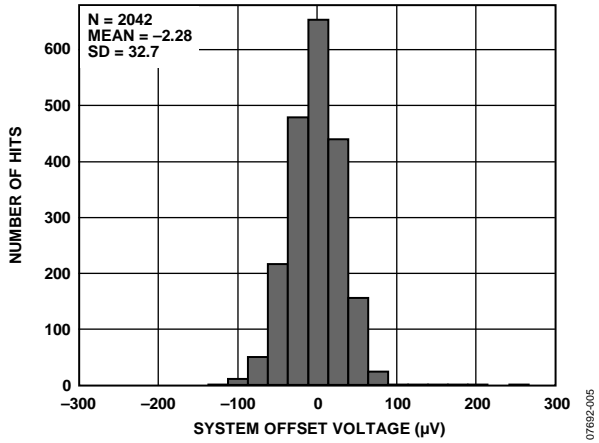

Figure 7. Distribution of Typical System Offset Voltage

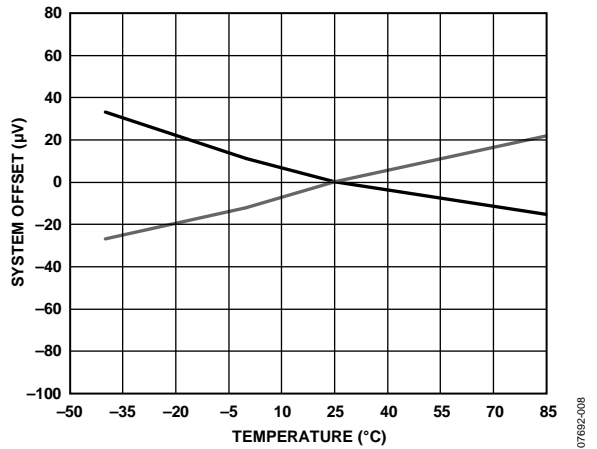

Figure 10. System Offset vs. Temperature, Normalized at 25°C

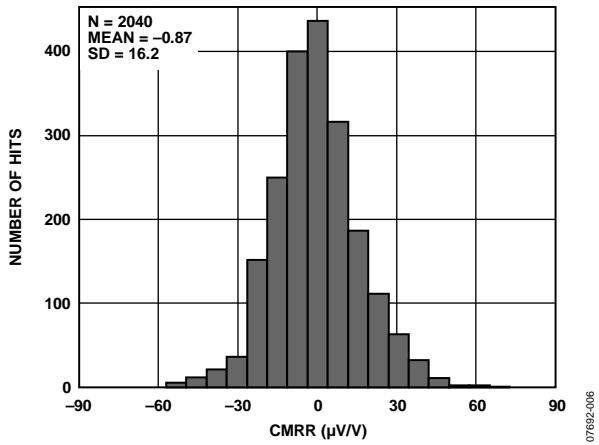

Figure 8. Distribution of Typical Common-Mode Rejection

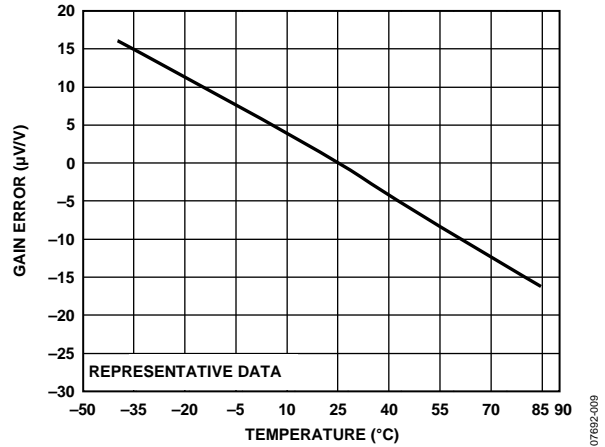

Figure 11. Gain Error vs. Temperature, Normalized at 25°C

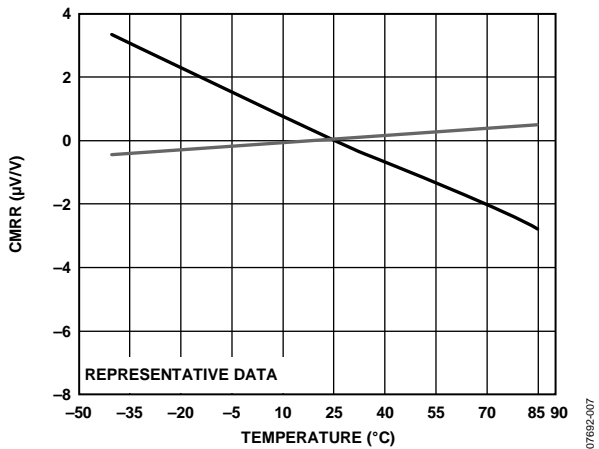

Figure 9. CMRR vs. Temperature, Normalized at 25°C

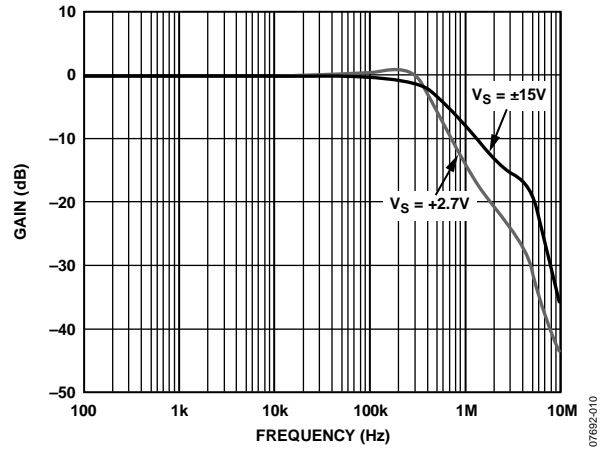

Figure 12. Gain vs. Frequency, $V_S = \pm 15\text{ V}$, $+2.7\text{ V}$

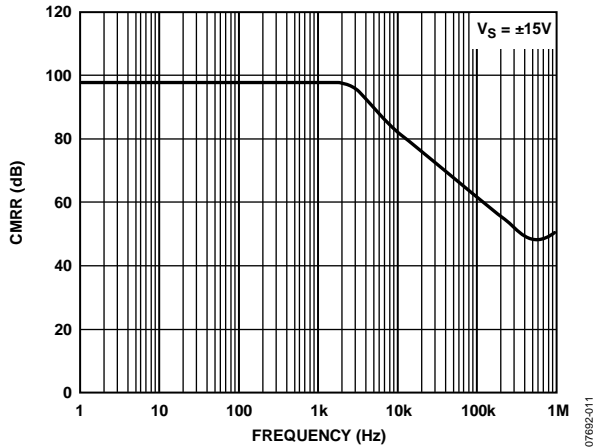

Figure 13. CMRR vs. Frequency

07692-011

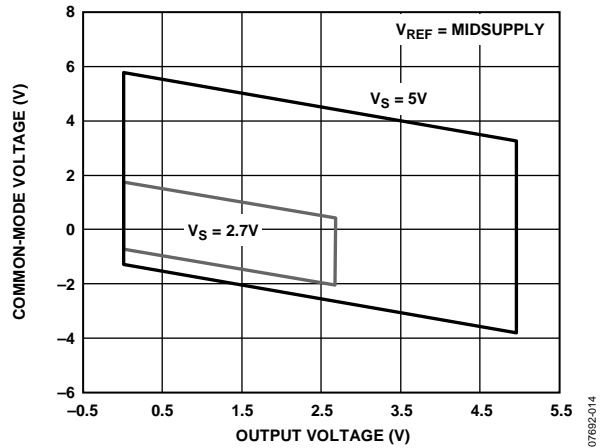

Figure 16. Input Common-Mode Voltage vs. Output Voltage, 5V and 2.7V Supplies, $V_{REF} = \text{Midsupply}$

07692-014

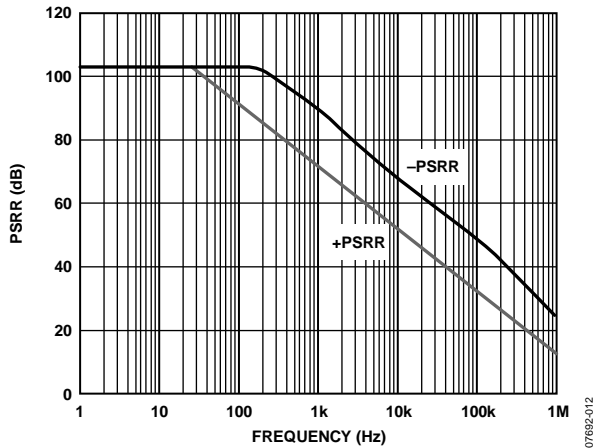

Figure 14. PSRR vs. Frequency

07692-012

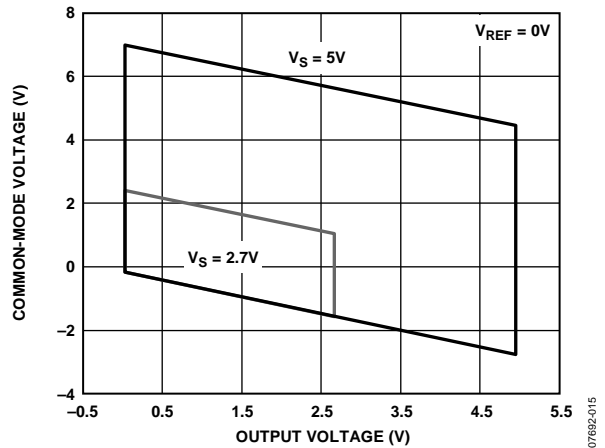

Figure 17. Input Common-Mode Voltage vs. Output Voltage, 5V and 2.7V Supplies, $V_{REF} = 0V$

07692-015

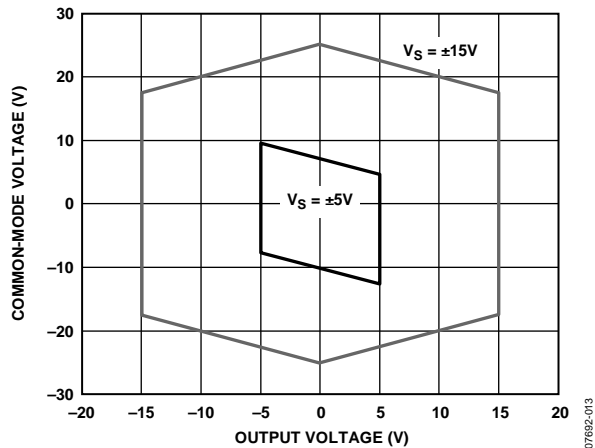

Figure 15. Input Common-Mode Voltage vs. Output Voltage, $\pm 15V$ and $\pm 5V$ Supplies

07692-013

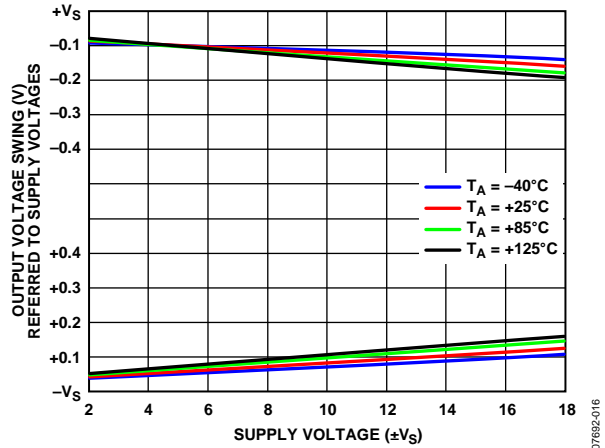

Figure 18. Output Voltage Swing vs. Supply Voltage Per Channel and Temperature, $R_L = 10\text{ k}\Omega$

07692-016

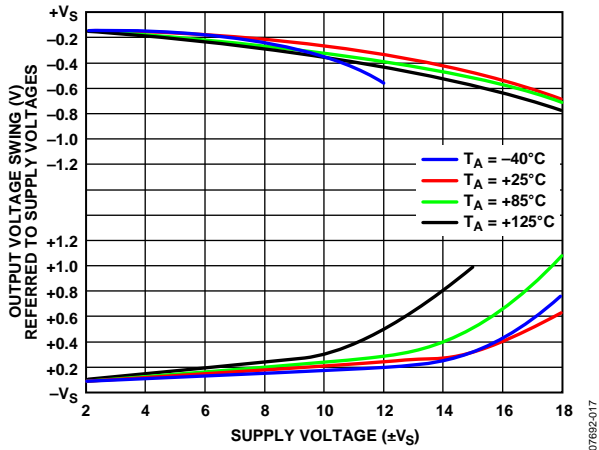

Figure 19. Output Voltage Swing vs. Supply Voltage Per Channel and Temperature, $R_L = 2\text{ k}\Omega$

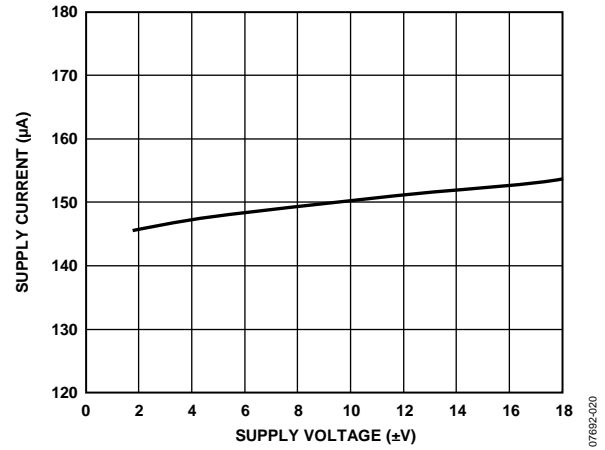

Figure 22. Supply Current Per Channel vs. Dual Supply Voltage, $V_{IN} = 0\text{ V}$

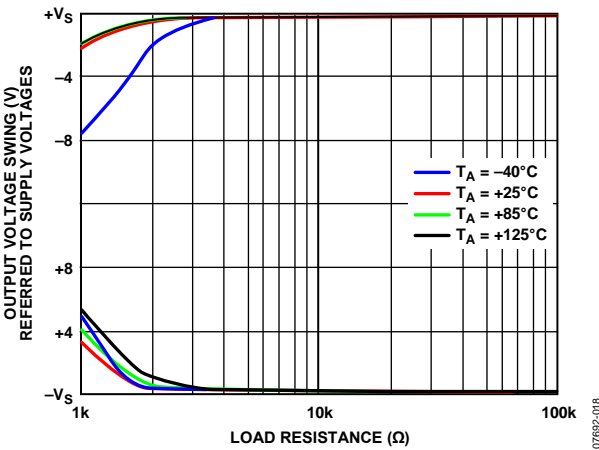

Figure 20. Output Voltage Swing vs. R_L and Temperature, $V_S = \pm 15\text{ V}$

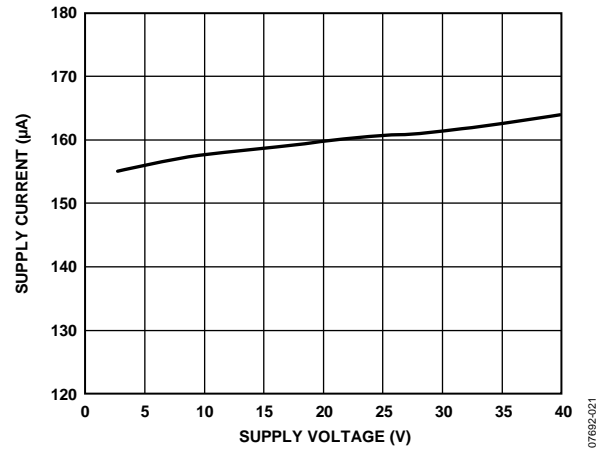

Figure 23. Supply Current Per Channel vs. Single-Supply Voltage, $V_{IN} = 0\text{ V}$, $V_{REF} = 0\text{ V}$

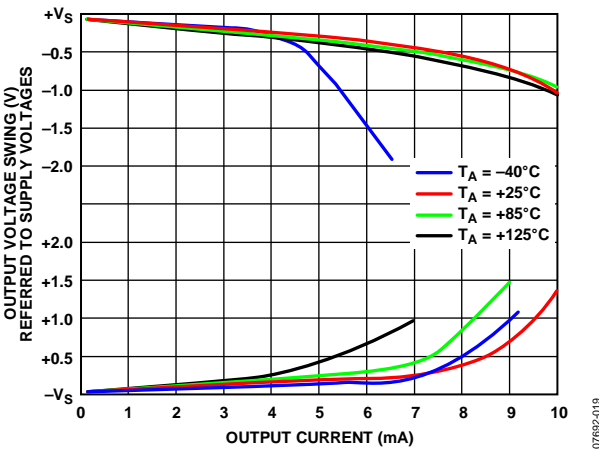

Figure 21. Output Voltage Swing vs. I_{OUT} and Temperature, $V_S = \pm 15\text{ V}$

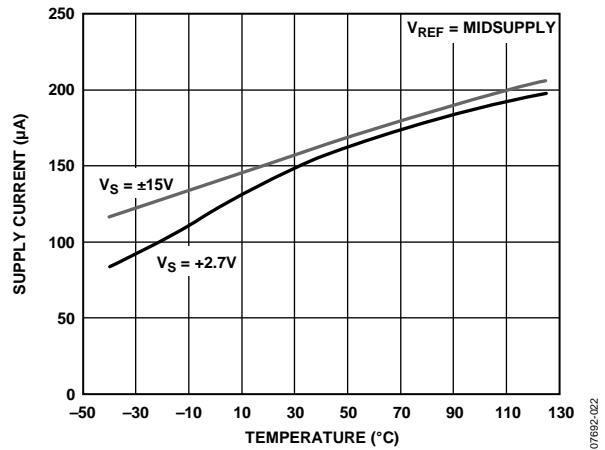

Figure 24. Supply Current Per Channel vs. Temperature

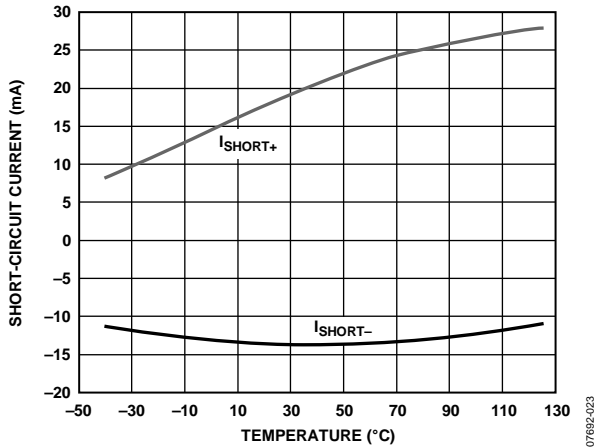

Figure 25. Short-Circuit Current Per Channel vs. Temperature

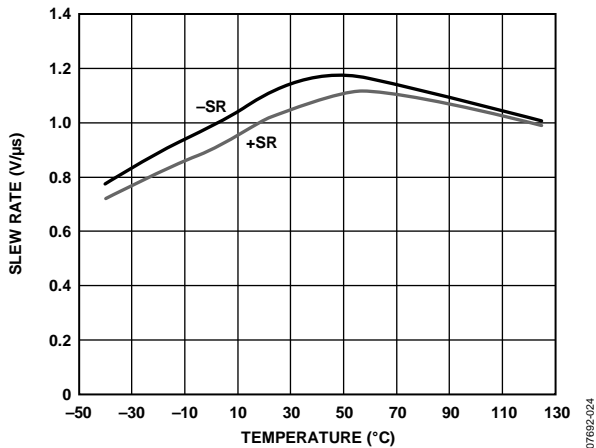

Figure 26. Slew Rate vs. Temperature, $V_{IN} = 20\text{ V p-p}$, 1 kHz

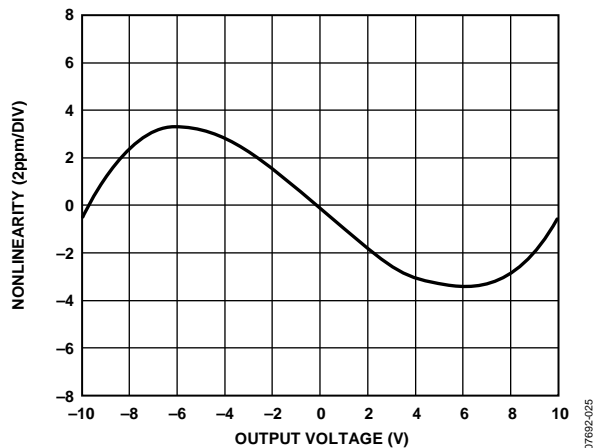

Figure 27. Gain Nonlinearity, $V_S = \pm 15\text{ V}$, $R_L \geq 2\text{ k}\Omega$

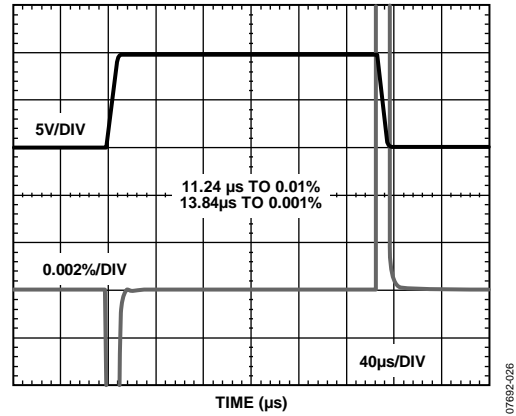

Figure 28. Large-Signal Pulse Response and Settling Time, 10 V Step, $V_S = \pm 15\text{ V}$

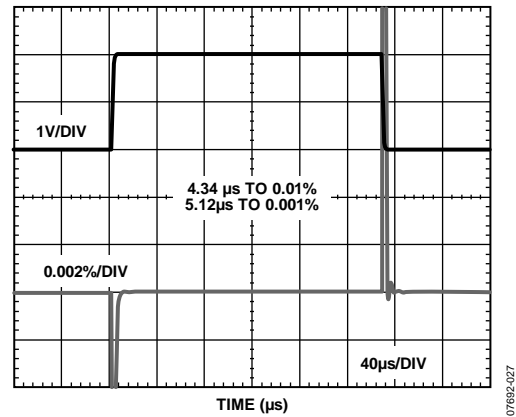

Figure 29. Large-Signal Pulse Response and Settling Time, 2 V Step, $V_S = 2.7\text{ V}$

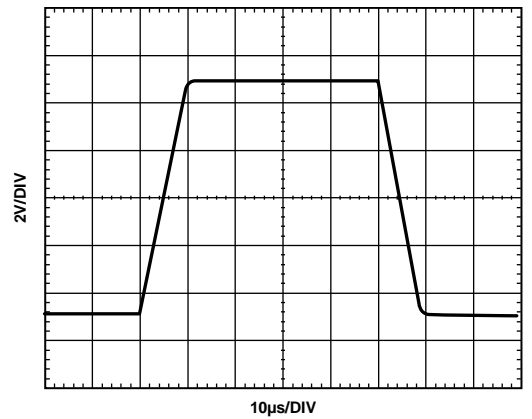

Figure 30. Large-Signal Step Response

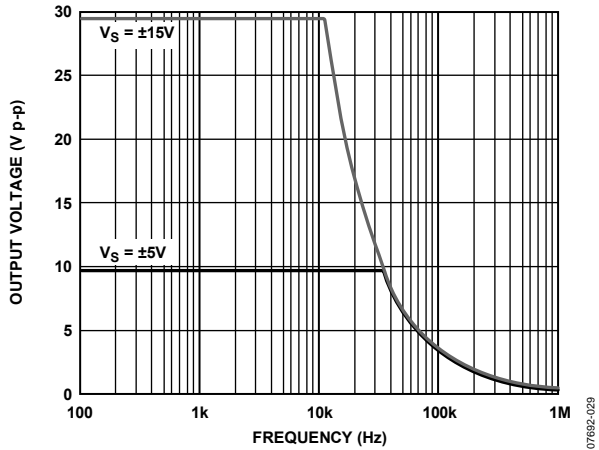

Figure 31. Maximum Output Voltage vs. Frequency, $V_S = \pm 15\text{ V}, \pm 5\text{ V}$

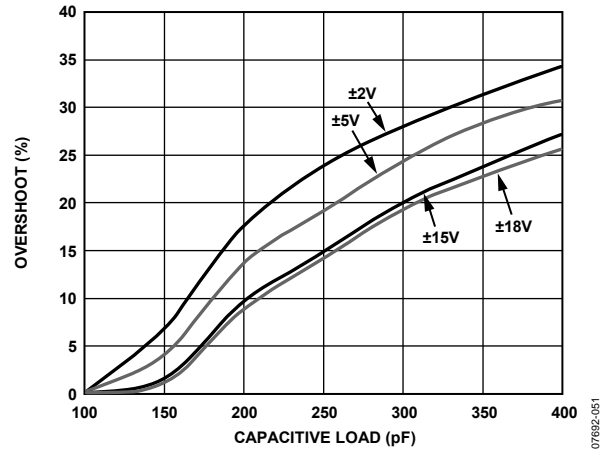

Figure 34. Small-Signal Overshoot vs. Capacitive Load, $R_L \geq 2\text{ k}\Omega$

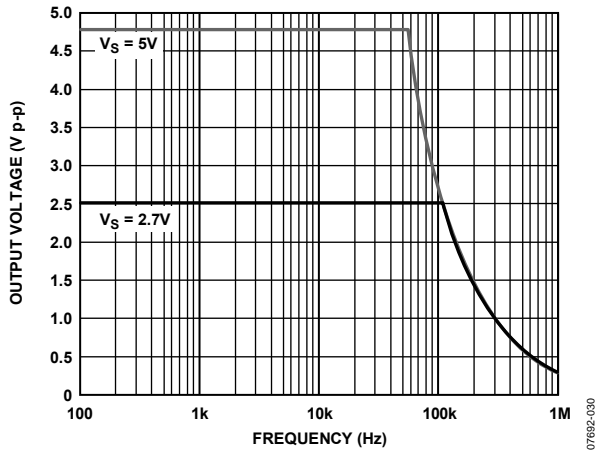

Figure 32. Maximum Output Voltage vs. Frequency, $V_S = 5\text{ V}, 2.7\text{ V}$

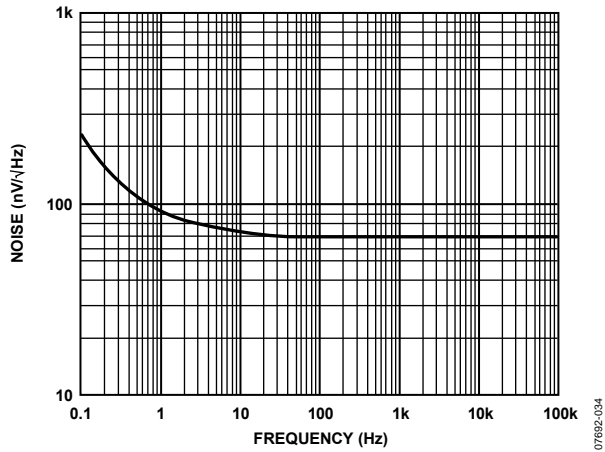

Figure 35. Voltage Noise Density vs. Frequency

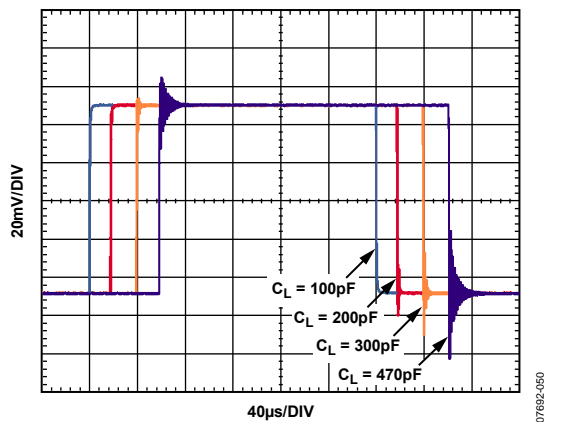

Figure 33. Small-Signal Step Response for Various Capacitive Loads

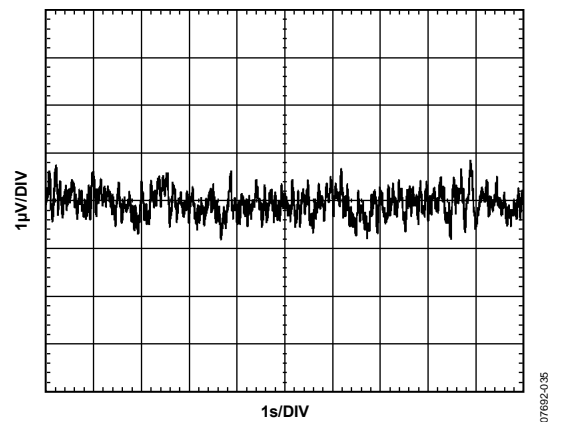

Figure 36. 0.1 Hz to 10 Hz Voltage Noise

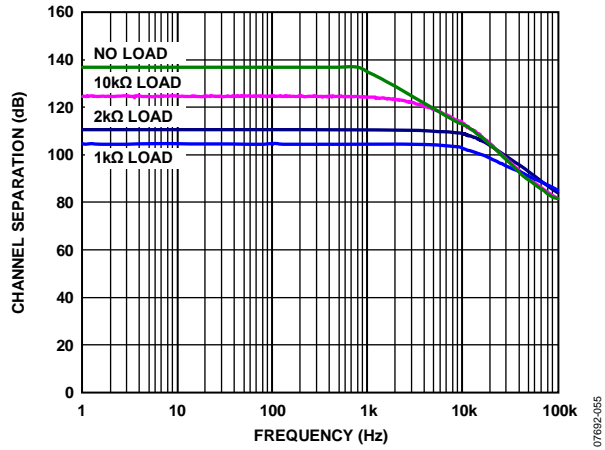

Figure 37. Channel Separation

07662-065

THEORY OF OPERATION

CIRCUIT INFORMATION

Each channel of the AD8276/AD8277 consists of a low power, low noise op amp and four laser-trimmed on-chip resistors. These resistors can be externally connected to make a variety of amplifier configurations, including difference, noninverting, and inverting configurations. Taking advantage of the integrated resistors of the AD8276/AD8277 provides the designer with several benefits over a discrete design, including smaller size, lower cost, and better ac and dc performance.

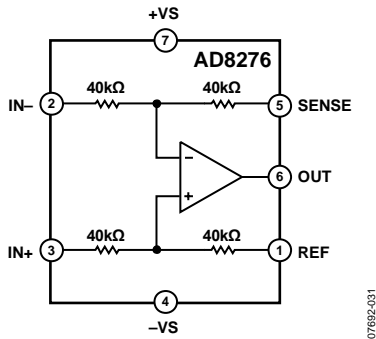

Figure 38. Functional Block Diagram

DC Performance

Much of the dc performance of op amp circuits depends on the accuracy of the surrounding resistors. Using superposition to analyze a typical difference amplifier circuit, as is shown in Figure 39, the output voltage is found to be

$$V_{OUT} = V_{IN+} \left(\frac{R2}{R1 + R2} \right) \left(1 + \frac{R4}{R3} \right) - V_{IN-} \left(\frac{R4}{R3} \right)$$

This equation demonstrates that the gain accuracy and common-mode rejection ratio of the AD8276/AD8277 is determined primarily by the matching of resistor ratios. Even a 0.1% mismatch in one resistor degrades the CMRR to 66 dB for a $G = 1$ difference amplifier.

The difference amplifier output voltage equation can be reduced to

$$V_{OUT} = \frac{R4}{R3} (V_{IN+} - V_{IN-})$$

as long as the following ratio of the resistors is tightly matched:

$$\frac{R2}{R1} = \frac{R4}{R3}$$

The resistors on the AD8276/AD8277 are laser trimmed to match accurately. As a result, the AD8276/AD8277 provide superior performance over a discrete solution, enabling better CMRR, gain accuracy, and gain drift, even over a wide temperature range.

AC Performance

Component sizes and trace lengths are much smaller in an IC than on a PCB, so the corresponding parasitic elements are also smaller. This results in better ac performance of the AD8276/AD8277. For example, the positive and negative input terminals of the AD8276/AD8277 op amps are intentionally not pinned out. By not connecting these nodes to the traces on the PCB, the capacitance remains low, resulting in improved loop stability and excellent common-mode rejection over frequency.

DRIVING THE AD8276/AD8277

Care should be taken to drive the AD8276/AD8277 with a low impedance source: for example, another amplifier. Source resistance of even a few kilohms ($k\Omega$) can unbalance the resistor ratios and, therefore, significantly degrade the gain accuracy and common-mode rejection of the AD8276/AD8277. Because all configurations present several kilohms of input resistance, the AD8276/AD8277 do not require a high current drive from the source and so are easy to drive.

INPUT VOLTAGE RANGE

The AD8276/AD8277 are able to measure input voltages beyond the supply rails. The internal resistors divide down the voltage before it reaches the internal op amp and provide protection to the op amp inputs. Figure 39 shows an example of how the voltage division works in a difference amplifier configuration. For the AD8276/AD8277 to measure correctly, the input voltages at the input nodes of the internal op amp must stay below 1.5 V of the positive supply rail and can exceed the negative supply rail by 0.1 V. Refer to the Power Supplies section for more details.

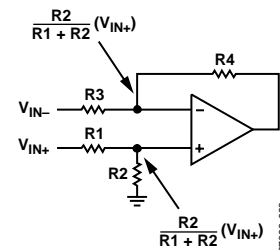

Figure 39. Voltage Division in the Difference Amplifier Configuration

The AD8276/AD8277 have integrated ESD diodes at the inputs that provide overvoltage protection. This feature simplifies system design by eliminating the need for additional external protection circuitry, and enables a more robust system.

The voltages at any of the inputs of the parts can safely range from $+V_S - 40$ V up to $-V_S + 40$ V. For example, on ± 10 V supplies, input voltages can go as high as ± 30 V. Care should be taken to not exceed the $+V_S - 40$ V to $-V_S + 40$ V input limits to avoid risking damage to the parts.

POWER SUPPLIES

The AD8276/AD8277 operate extremely well over a very wide range of supply voltages. They can operate on a single supply as low as 2 V and as high as 36 V, under appropriate setup conditions.

For best performance, the user must exercise care that the setup conditions ensure that the internal op amp is biased correctly. The internal input terminals of the op amp must have sufficient voltage headroom to operate properly. Proper operation of the part requires at least 1.5 V between the positive supply rail and the op amp input terminals. This relationship is expressed in the following equation:

$$\frac{R1}{R1 + R2} V_{REF} < +V_S - 1.5 \text{ V}$$

For example, when operating on a $+V_S = 2 \text{ V}$ single supply and $V_{REF} = 0 \text{ V}$, it can be seen from Figure 40 that the input terminals of the op amp are biased at 0 V, allowing more than the required 1.5 V headroom. However, if $V_{REF} = 1 \text{ V}$ under the same conditions, the input terminals of the op amp are biased at 0.5 V, barely allowing the required 1.5 V headroom. This setup does not allow any practical voltage swing on the noninverting input. Therefore, the user needs to increase the supply voltage or decrease V_{REF} to restore proper operation.

The AD8276/AD8277 are typically specified at single- and dual-supplies, but they can be used with unbalanced supplies, as well; for example, $-V_S = -5 \text{ V}$, $+V_S = 20 \text{ V}$. The difference between the two supplies must be kept below 36 V. The positive supply rail must be at least 2 V above the negative supply and reference voltage.

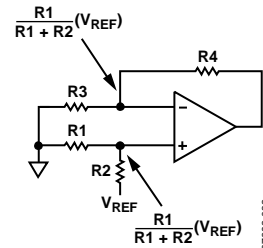

Figure 40. Ensure Sufficient Voltage Headroom on the Internal Op Amp Inputs

Use a stable dc voltage to power the AD8276/AD8277. Noise on the supply pins can adversely affect performance. Place a bypass capacitor of 0.1 μF between each supply pin and ground, as close as possible to each supply pin. Use a tantalum capacitor of 10 μF between each supply and ground. It can be farther away from the supply pins and, typically, it can be shared by other precision integrated circuits.

APPLICATIONS INFORMATION CONFIGURATIONS

The AD8276/AD8277 can be configured in several ways (see Figure 42 to Figure 46). All of these configurations have excellent gain accuracy and gain drift because they rely on the internal matched resistors. Note that Figure 43 shows the AD8276/AD8277 as difference amplifiers with a midsupply reference voltage at the noninverting input. This allows the AD8276/AD8277 to be used as a level shifter, which is appropriate in single-supply applications that are referenced to midsupply.

As with the other inputs, the reference must be driven with a low impedance source to maintain the internal resistor ratio. An example using the low power, low noise OP1177 as a reference is shown in Figure 41.

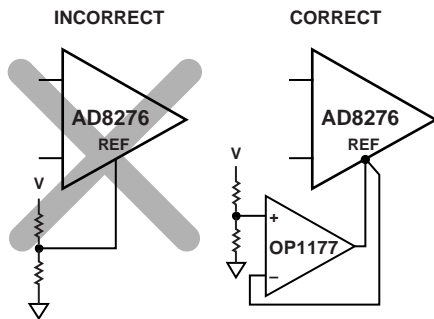

Figure 41. Driving the Reference Pin

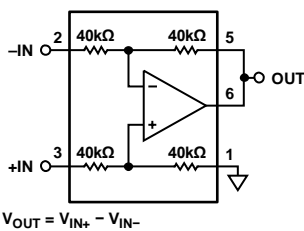

Figure 42. Difference Amplifier, Gain = 1

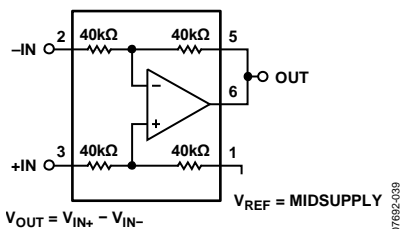

Figure 43. Difference Amplifier, Gain = 1, Referenced to Midsupply

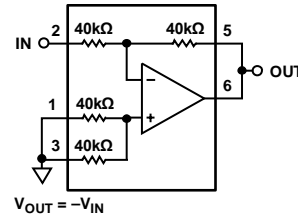

Figure 44. Inverting Amplifier, Gain = -1

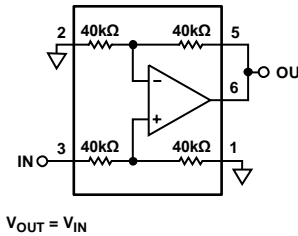

Figure 45. Noninverting Amplifier, Gain = 1

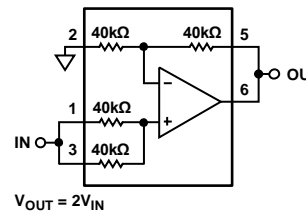

Figure 46. Noninverting Amplifier, Gain = 2

DIFFERENTIAL OUTPUT

Certain systems require a differential signal for better performance, such as the inputs to differential analog-to-digital converters. Figure 47 shows how the AD8276/AD8277 can be used to convert a single-ended output from an AD8226 instrumentation amplifier into a differential signal. The internal matched resistors of the AD8276 at the inverting input maximize gain accuracy while generating a differential signal. The resistors at the noninverting input can be used as a divider to set and track the common-mode voltage accurately to midsupply, especially when running on a single supply or in an environment where the supply fluctuates. The resistors at the noninverting input can also be shorted and set to any appropriate bias voltage. Note that the $V_{BIAS} = V_{CM}$ node indicated in Figure 47 is internal to the AD8276 because it is not pinned out.

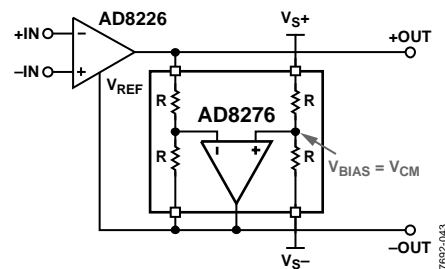

Figure 47. Differential Output With Supply Tracking on Common-Mode Voltage Reference

The differential output voltage and common-mode voltage of the AD8226 is shown in the following equations:

$$V_{DIFF_OUT} = V_{+OUT} - V_{-OUT} = Gain_{AD8226} \times (V_{+IN} - V_{-IN})$$

$$V_{CM} = (V_{S+} - V_{S-})/2 = V_{BIAS}$$

Refer to the [AD8226](#) data sheet for additional information.

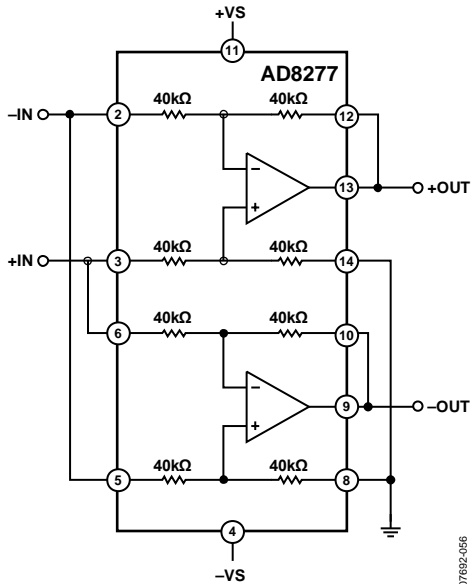

Figure 48. AD8277 Differential Output Configuration

The two difference amplifiers of the AD8277 can be configured to provide a differential output, as shown in Figure 48. This differential output configuration is suitable for various applications, such as strain gage excitation and single-ended-to-differential conversion. The differential output voltage has a gain of 2 as shown in the following equation:

$$V_{DIFF_OUT} = V_{+OUT} - V_{-OUT} = 2 \times (V_{+IN} - V_{-IN})$$

CURRENT SOURCE

The AD8276 difference amplifier can be implemented as part of a voltage-to-current converter or a precision constant current source as shown in Figure 49. Using an integrated precision solution such as the AD8276 provides several advantages over a discrete solution, including space-saving, improved gain accuracy, and temperature drift. The internal resistors are tightly matched to minimize error and temperature drift. If the external resistors, R1 and R2, are not well-matched, they become a significant source of error in the system, so precision resistors are recommended to maintain performance. The [ADR821](#) provides a precision voltage reference and integrated op amp that also reduces error in the signal chain.

The AD8276 has rail-to-rail output capability that allows higher current outputs.

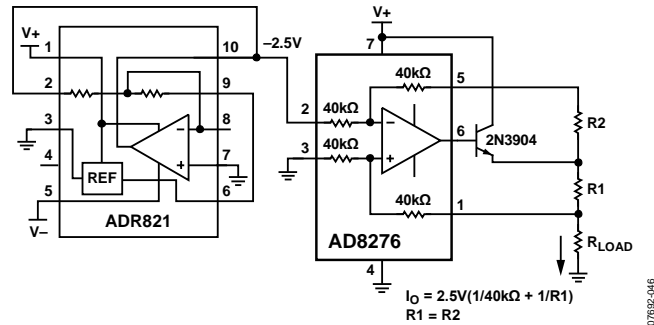

Figure 49. Constant Current Source

VOLTAGE AND CURRENT MONITORING

Voltage and current monitoring is critical in the following applications: power line metering, power line protection, motor control applications, and battery monitoring. The AD8276/AD8277 can be used to monitor voltages and currents in a system, as shown in Figure 50. As the signals monitored by the AD8276/AD8277 rise above or drop below critical levels, a circuit event can be triggered to correct the situation or raise a warning.

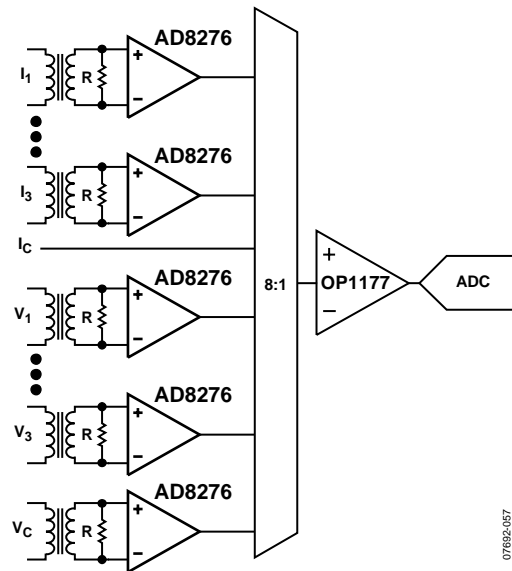

Figure 50. Voltage and Current Monitoring in 3-Phase Power Line Protection Using the AD8276

Figure 50 shows an example of how the AD8276 can be used to monitor voltage and current on a 3-phase power supply. I₁ through I₃ are the currents to be monitored, and V₁ through V₃ are the voltages to be monitored on each phase. I_C and V_C are the common or zero lines. Couplers or transformers interface the power lines to the front-end circuitry and provide attenuation, isolation, and protection.

On the current monitoring side, current transformers (CTs) step down the power-line current and isolate the front-end circuitry from the high voltage and high current lines. Across the inputs of each difference amplifier is a shunt resistor that converts the coupled current into a voltage. The value of the

resistor is determined by the characteristics of the coupler or transformer and desired input voltage ranges to the AD8276.

On the voltage monitoring side, potential transformers (PTs) are used to provide coupling and galvanic isolation. The PTs present a load to the power line and step down the voltage to a measurable level. The AD8276 helps to build a robust system because it allows input voltages that are almost double its supply voltage, while providing additional input protection in the form of the integrated ESD diodes.

Not only does the AD8276 monitor the voltage and currents on the power lines, it is able to reject very high common-mode voltages that may appear at the inputs. The AD8276 also performs the differential-to-single-ended conversion on the input voltages. The 80 kΩ differential input impedance that the AD8276 presents is high enough that it should not load the input signals.

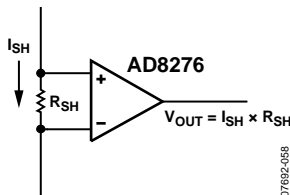

Figure 51. AD8276 Monitoring Current Through a Shunt Resistor

Figure 51 shows how the AD8276 can be used to monitor the current through a small shunt resistor. This is useful in power critical applications such as motor control (current sense) and battery monitoring.

INSTRUMENTATION AMPLIFIER

The AD8276/AD8277 can be used as building blocks for a low power, low cost instrumentation amplifier. An instrumentation amplifier provides high impedance inputs and delivers high common-mode rejection. Combining the AD8276 with an Analog Devices, Inc., low power amplifier (see Table 8) creates a precise, power efficient voltage measurement solution suitable for power critical systems.

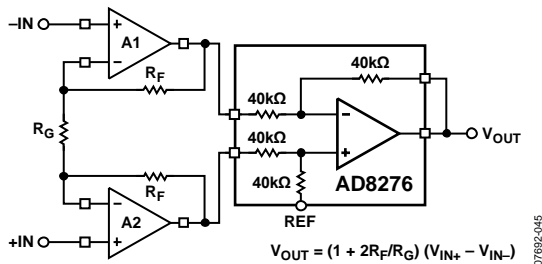

Figure 52. Low Power Precision Instrumentation Amplifier

Table 8. Low Power Op Amps

Op Amp (A1, A2)	Features
AD8506	Dual micropower op amp
AD8607	Precision dual micropower op amp
AD8617	Low cost CMOS micropower op amp
AD8667	Dual precision CMOS micropower op amp

It is preferable to use dual op amps for the high impedance inputs because they have better matched performance and track each other over temperature. The AD8276 difference amplifiers cancel out common-mode errors from the input op amps, if they track each other. The differential gain accuracy of the in-amp is proportional to how well the input feedback resistors (R_F) match each other. The CMRR of the in-amp increases as the differential gain is increased (1 + 2R_F/R_G), but a higher gain also reduces the common-mode voltage range. Note that dual supplies must be used for proper operation of this configuration.

Refer to *A Designer's Guide to Instrumentation Amplifiers* for more design ideas and considerations.

RTD

Resistive temperature detectors (RTDs) are often measured remotely in industrial control systems. The wire lengths needed to connect the RTD to a controller add significant cost and resistance errors to the measurement. The AD8276 difference amplifier is effective in measuring errors caused by wire resistance in remote 3-wire RTD systems, allowing the user to cancel out the errors introduced by the wires. Its excellent gain drift provides accurate measurements and stable performance over a wide temperature range.

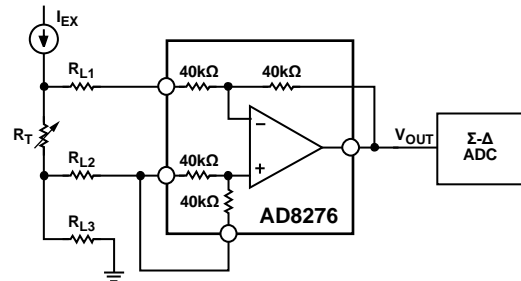
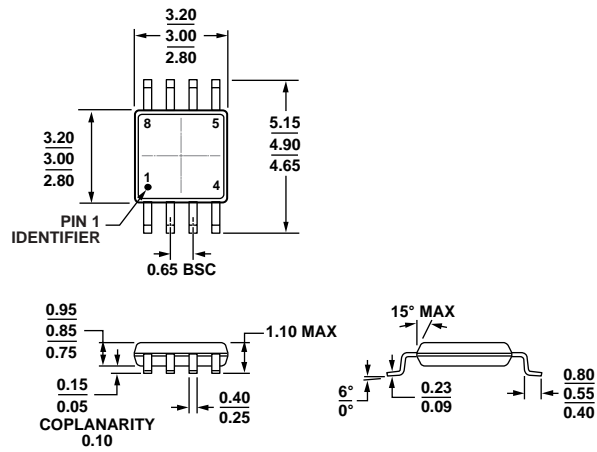

Figure 53. 3-Wire RTD Cable Resistance Error Measurement

OUTLINE DIMENSIONS



COMPLIANT TO JEDEC STANDARDS MO-187-AA

Figure 54. 8-Lead Mini Small Outline Package [MSOP] (RM-8)

Dimensions shown in millimeters

10-07-2009 B

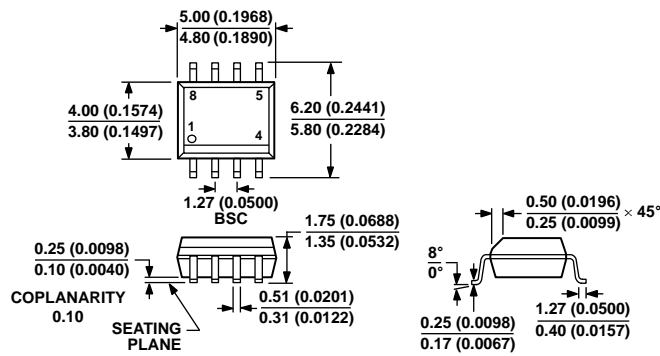

COMPLIANT TO JEDEC STANDARDS MS-012-AA

CONTROLLING DIMENSIONS ARE IN MILLIMETERS; INCH DIMENSIONS (IN PARENTHESES) ARE ROUNDED-OFF MILLIMETER EQUIVALENTS FOR REFERENCE ONLY AND ARE NOT APPROPRIATE FOR USE IN DESIGN.

Figure 55. 8-Lead Standard Small Outline Package [SOIC_N] Narrow Body (R-8)

Dimensions shown in millimeters and (inches)

012A07-A

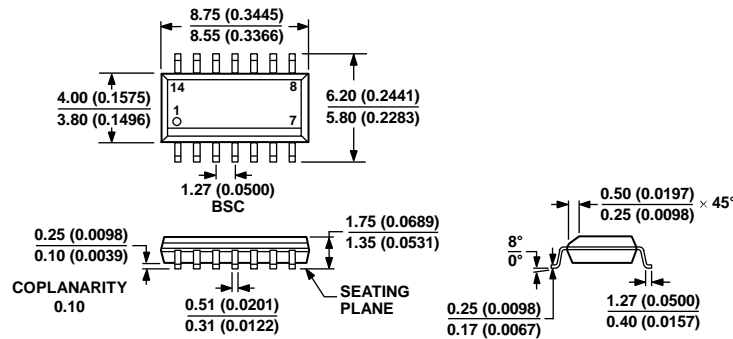

COMPLIANT TO JEDEC STANDARDS MS-012-AB
 CONTROLLING DIMENSIONS ARE IN MILLIMETERS; INCH DIMENSIONS
 (IN PARENTHESES) ARE ROUNDED-OFF MILLIMETER EQUIVALENTS FOR
 REFERENCE ONLY AND ARE NOT APPROPRIATE FOR USE IN DESIGN.

Figure 56. 14-Lead Standard Small Outline Package [SOIC_N]
 Narrow Body (R-14)
 Dimensions shown in millimeters and (inches)

090606-A

ORDERING GUIDE

Model ¹	Temperature Range	Package Description	Package Option	Branding
AD8276ARMZ	-40°C to +85°C	8-Lead MSOP	RM-8	H1P
AD8276ARMZ-R7	-40°C to +85°C	8-Lead MSOP, 7" Tape and Reel	RM-8	H1P
AD8276ARMZ-RL	-40°C to +85°C	8-Lead MSOP, 13" Tape and Reel	RM-8	H1P
AD8276ARZ	-40°C to +85°C	8-Lead SOIC_N	R-8	
AD8276ARZ-R7	-40°C to +85°C	8-Lead SOIC_N, 7" Tape and Reel	R-8	
AD8276ARZ-RL	-40°C to +85°C	8-Lead SOIC_N, 13" Tape and Reel	R-8	
AD8276BRMZ	-40°C to +85°C	8-Lead MSOP	RM-8	H1Q
AD8276BRMZ-R7	-40°C to +85°C	8-Lead MSOP, 7" Tape and Reel	RM-8	H1Q
AD8276BRMZ-RL	-40°C to +85°C	8-Lead MSOP, 13" Tape and Reel	RM-8	H1Q
AD8276BRZ	-40°C to +85°C	8-Lead SOIC_N	R-8	
AD8276BRZ-R7	-40°C to +85°C	8-Lead SOIC_N, 7" Tape and Reel	R-8	
AD8276BRZ-RL	-40°C to +85°C	8-Lead SOIC_N, 13" Tape and Reel	R-8	
AD8277ARZ	-40°C to +85°C	14-Lead SOIC_N	R-14	
AD8277ARZ-R7	-40°C to +85°C	14-Lead SOIC_N, 7" Tape and Reel	R-14	
AD8277ARZ-RL	-40°C to +85°C	14-Lead SOIC_N, 13" Tape and Reel	R-14	
AD8277BRZ	-40°C to +85°C	14-Lead SOIC_N	R-14	
AD8277BRZ-R7	-40°C to +85°C	14-Lead SOIC_N, 7" Tape and Reel	R-14	
AD8277BRZ-RL	-40°C to +85°C	14-Lead SOIC_N, 13" Tape and Reel	R-14	

¹ Z = RoHS Compliant Part.

Mouser Electronics

Authorized Distributor

Click to View Pricing, Inventory, Delivery & Lifecycle Information:

[Analog Devices Inc.:](#)

[AD8276ARMZ](#) [AD8276ARMZ-R7](#) [AD8276ARMZ-RL](#) [AD8276ARZ](#) [AD8276ARZ-R7](#) [AD8276ARZ-RL](#) [AD8276BRMZ](#)
[AD8276BRMZ-R7](#) [AD8276BRMZ-RL](#) [AD8276BRZ](#) [AD8276BRZ-R7](#) [AD8276BRZ-RL](#) [AD8277ARZ](#) [AD8277ARZ-R7](#)
[AD8277ARZ-RL](#) [AD8277BRZ](#) [AD8277BRZ-R7](#) [AD8277BRZ-RL](#) [AD8277-EVALZ](#)