

### FEATURES

- 400 MSPS internal clock speed
- Integrated 14-bit DAC
- 32-bit tuning word
- Phase noise  $\leq -120$  dBc/Hz @ 1 kHz offset (DAC output)
- Excellent dynamic performance
- $>80$  dB SFDR @ 160 MHz ( $\pm 100$  kHz offset)  $A_{out}$
- Serial I/O control
- 1.8 V power supply
- Software and hardware controlled power-down
- 48-lead TQFP\_EP package
- Support for 5 V input levels on most digital inputs
- PLL REFCLK multiplier (4x to 20x)
- Internal oscillator, can be driven by a single crystal
- Phase modulation capability
- Multichip synchronization
- High speed comparator (200 MHz toggle rate)

### APPLICATIONS

- Agile LO frequency synthesis
- Programmable clock generators
- Test and measurement equipment
- Acousto-optic device drivers

### GENERAL DESCRIPTION

The AD9952 is a direct digital synthesizer (DDS) featuring a 14-bit DAC (digital-to-analog converter) and operating up to 400 MSPS. The AD9952 uses advanced DDS technology, coupled with an internal high speed, high performance DAC to form a digitally programmable, complete high frequency synthesizer capable of generating a frequency-agile analog output sinusoidal waveform at up to 200 MHz. The AD9952 is designed to provide fast frequency hopping and fine tuning resolution (32-bit frequency tuning word). The frequency tuning and control words are loaded into the AD9952 via a serial I/O port.

The AD9952 is specified to operate over the extended industrial temperature range of  $-40^{\circ}\text{C}$  to  $+105^{\circ}\text{C}$ .

### FUNCTIONAL BLOCK DIAGRAM

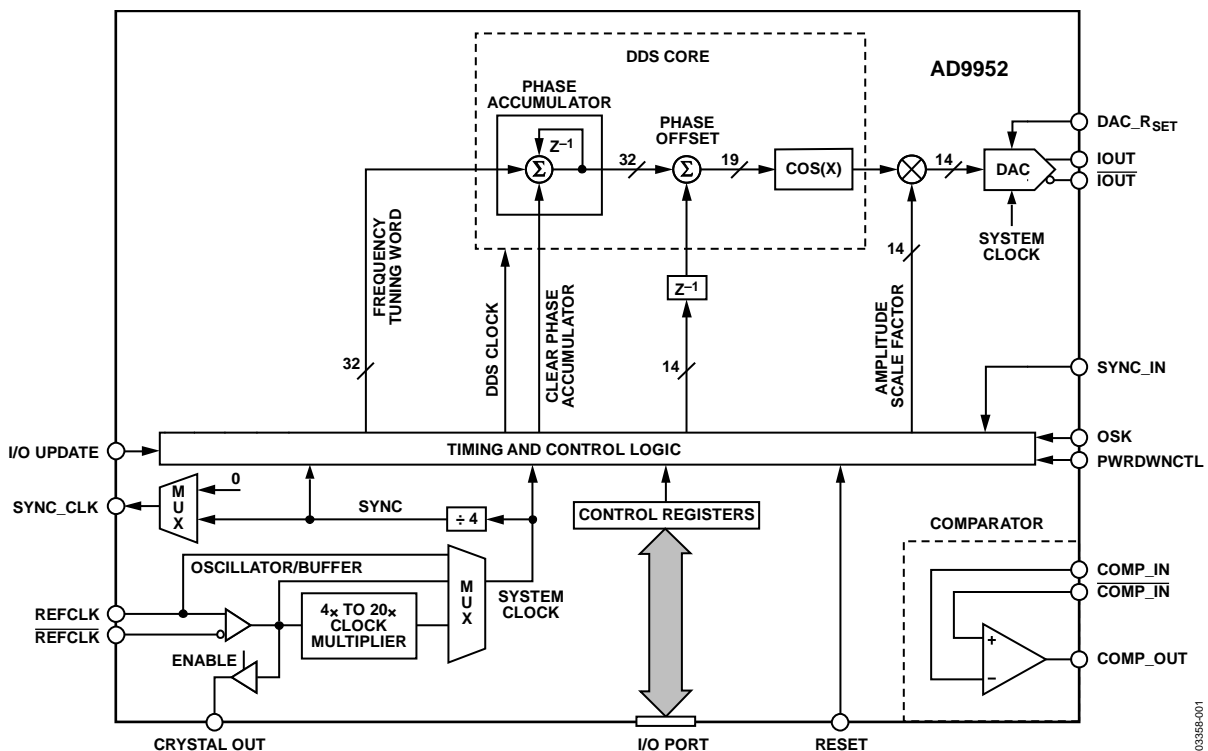

Figure 1.

#### Rev. B

Information furnished by Analog Devices is believed to be accurate and reliable. However, no responsibility is assumed by Analog Devices for its use, nor for any infringements of patents or other rights of third parties that may result from its use. Specifications subject to change without notice. No license is granted by implication or otherwise under any patent or patent rights of Analog Devices. Trademarks and registered trademarks are the property of their respective owners.

## TABLE OF CONTENTS

Features .....	1	Control Register Bit Descriptions .....	16
Applications.....	1	Other Register Descriptions .....	18
General Description .....	1	Modes of Operation .....	18
Functional Block Diagram .....	1	Programming Features .....	18
Electrical Specifications .....	3	Synchronizing Multiple AD9952s.....	20
Absolute Maximum Ratings.....	6	Serial Port Operation.....	20
ESD Caution.....	6	Power-Down Functions.....	23
Pin Configuration and Function Descriptions.....	7	Layout Considerations.....	25
Typical Performance Characteristics .....	9	Suggested Application Circuits.....	26
Equivalent Input/Output Circuits .....	12	Outline Dimensions .....	27
Theory of Operation .....	13	Ordering Guide .....	27
Component Blocks.....	13		

## REVISION HISTORY

### 5/09—Rev. A to Rev. B

Changes to Comparator Input Characteristics, Hysteresis Parameter, Table 1.....	4
Changes to Pin Configuration and Function Descriptions Section and Table 3.....	7
Changes to Table 5.....	15
Changes to Serial Interface Port Pin Description Section .....	22
Changes to Figure 32.....	26
Added Exposed Pad Notation to Outline Dimensions .....	27
Changes to Ordering Guide .....	27

### 5/06—Rev. 0 to Rev. A

Updated Format.....	Universal
Changes to Electrical Specifications Section .....	3
Changes to Figure 3.....	9
Changes to Serial Port Operation Section.....	20
Inserted Figure 24, Figure 25, and Figure 26 .....	21

### 12/03—Revision 0: Initial Version

## ELECTRICAL SPECIFICATIONS

AVDD, DVDD = 1.8 V ± 5%, DVDD\_I/O = 3.3 V ± 5%, DAC\_R<sub>SET</sub> = 3.92 kΩ, external reference clock frequency = 400 MHz with REFCLK multiplier disabled, unless otherwise noted. DAC output must be referenced to AVDD, not AGND.

Table 1.

Parameter	Temp	Min	Typ	Max	Unit
<b>REF CLOCK INPUT CHARACTERISTICS</b>					
Frequency Range					
REFCLK Multiplier Disabled	Full	1		400	MHz
REFCLK Multiplier Enabled @ 4×	Full	20		100	MHz
REFCLK Multiplier Enabled @ 20×	Full	4		20	MHz
Input Capacitance	25°C		3		pF
Input Impedance	25°C		1.5		kΩ
Duty Cycle	25°C		50		%
Duty Cycle with REFCLK Multiplier Enabled	25°C	35		65	%
REFCLK Input Power <sup>1</sup>	Full	-15	0	+3	dBm
<b>DAC OUTPUT CHARACTERISTICS</b>					
Resolution			14		Bits
Full-Scale Output Current	25°C	5	10	15	mA
Gain Error	25°C	-10		+10	%FS
Output Offset	25°C			0.6	μA
Differential Nonlinearity	25°C		1		LSB
Integral Nonlinearity	25°C		2		LSB
Output Capacitance	25°C		5		pF
Residual Phase Noise @ 1 kHz Offset, 40 MHz A <sub>OUT</sub>					
REFCLK Multiplier Enabled @ 20×	25°C		-105		dBc/Hz
REFCLK Multiplier Enabled @ 4×	25°C		-115		dBc/Hz
REFCLK Multiplier Disabled	25°C		-132		dBc/Hz
Voltage Compliance Range	25°C	AVDD - 0.5		AVDD + 0.5	V
<b>Wideband Spurious-Free Dynamic Range (SFDR)</b>					
1 MHz to 10 MHz Analog Out	25°C		73		dBc
10 MHz to 40 MHz Analog Out	25°C		67		dBc
40 MHz to 80 MHz Analog Out	25°C		62		dBc
80 MHz to 120 MHz Analog Out	25°C		58		dBc
120 MHz to 160 MHz Analog Out	25°C		52		dBc
<b>Narrow-Band SFDR</b>					
40 MHz Analog Out (±1 MHz)	25°C		87		dBc
40 MHz Analog Out (±250 kHz)	25°C		89		dBc
40 MHz Analog Out (±50 kHz)	25°C		91		dBc
40 MHz Analog Out (±10 kHz)	25°C		93		dBc
80 MHz Analog Out (±1 MHz)	25°C		85		dBc
80 MHz Analog Out (±250 kHz)	25°C		87		dBc
80 MHz Analog Out (±50 kHz)	25°C		89		dBc
80 MHz Analog Out (±10 kHz)	25°C		91		dBc
120 MHz Analog Out (±1 MHz)	25°C		83		dBc
120 MHz Analog Out (±250 kHz)	25°C		85		dBc
120 MHz Analog Out (±50 kHz)	25°C		87		dBc
120 MHz Analog Out (±10 kHz)	25°C		89		dBc
160 MHz Analog Out (±1 MHz)	25°C		81		dBc
160 MHz Analog Out (±250 kHz)	25°C		83		dBc
160 MHz Analog Out (±50 kHz)	25°C		85		dBc
160 MHz Analog Out (±10 kHz)	25°C		87		dBc

# AD9952

Parameter	Temp	Min	Typ	Max	Unit
<b>COMPARATOR INPUT CHARACTERISTICS</b>					
Input Capacitance	25°C		3		pF
Input Resistance	25°C		500		kΩ
Input Current	25°C		±12		μA
Hysteresis	25°C	30		45	mV
<b>COMPARATOR OUTPUT CHARACTERISTICS</b>					
Logic 1 Voltage, High Z Load	Full	1.6			V
Logic 0 Voltage, High Z Load	Full			0.4	V
Propagation Delay	25°C		3		ns
Output Duty Cycle Error	25°C		±5		%
Rise/Fall Time, 5 pF Load	25°C			1	ns
Toggle Rate, High Z Load	25°C	200			MHz
Output Jitter <sup>2</sup>	25°C			1	ps rms
<b>COMPARATOR NARROW-BAND SFDR</b>					
10 MHz (±1 MHz)	25°C		80		dBc
10 MHz (±250 kHz)	25°C		85		dBc
10 MHz (±50 kHz)	25°C		90		dBc
10 MHz (±10 kHz)	25°C		95		dBc
70 MHz (±1 MHz)	25°C		80		dBc
70 MHz (±250 kHz)	25°C		85		dBc
70 MHz (±50 kHz)	25°C		90		dBc
70 MHz (±10 kHz)	25°C		95		dBc
110 MHz (±1 MHz)	25°C		80		dBc
110 MHz (±250 kHz)	25°C		85		dBc
110 MHz (±50 kHz)	25°C		90		dBc
110 MHz (±10 kHz)	25°C		95		dBc
140 MHz (±1 MHz)	25°C		80		dBc
140 MHz (±250 kHz)	25°C		85		dBc
140 MHz (±50 kHz)	25°C		90		dBc
140 MHz (±10 kHz)	25°C		95		dBc
160 MHz (±1 MHz)	25°C		80		dBc
160 MHz (±250 kHz)	25°C		85		dBc
160 MHz (±50 kHz)	25°C		90		dBc
160 MHz (±10 kHz)	25°C		95		dBc
<b>CLOCK GENERATOR OUTPUT JITTER<sup>3</sup></b>					
5 MHz A <sub>OUT</sub>	25°C		100		ps rms
10 MHz A <sub>OUT</sub>	25°C		60		ps rms
40 MHz A <sub>OUT</sub>	25°C		50		ps rms
80 MHz A <sub>OUT</sub>	25°C		50		ps rms
120 MHz A <sub>OUT</sub>	25°C		50		ps rms
140 MHz A <sub>OUT</sub>	25°C		50		ps rms
160 MHz A <sub>OUT</sub>	25°C		50		ps rms
<b>TIMING CHARACTERISTICS</b>					
Serial Control Bus					
Maximum Frequency <sup>4</sup>	Full		25		Mbps
Minimum Clock Pulse Width Low	Full	7			ns
Minimum Clock Pulse Width High	Full	7			ns
Maximum Clock Rise/Fall Time	Full		2		ns
Minimum Data Setup Time DVDD_I/O = 3.3 V <sup>5</sup> (TCSU, TDSU)	Full	3			ns
Minimum Data Setup Time DVDD_I/O = 1.8 V <sup>5</sup> (TCSU, TDSU)	Full	5			ns
Minimum Data Hold Time (TDH)	Full	0			ns
Maximum Data Valid Time (TDV)	Full		25		ns

Parameter	Temp	Min	Typ	Max	Unit
Wake-Up Time <sup>6</sup>	Full		1		ms
Minimum Reset Pulse Width High	Full	5			SYSCLK cycles <sup>7</sup>
I/O UPDATE to SYNC_CLK Setup Time DVDD_I/O = 3.3 V	Full	4			ns
I/O UPDATE to SYNC_CLK Setup Time DVDD_I/O = 3.3 V	Full	6			ns
I/O UPDATE, SYNC_CLK Hold Time	Full	0			ns
Latency					
I/O UPDATE to Frequency Change Propagation Delay	25°C	24			SYSCLK cycles
I/O UPDATE to Phase Offset Change Propagation Delay	25°C	24			SYSCLK cycles
I/O UPDATE to Amplitude Change Propagation Delay	25°C	16			SYSCLK cycles
CMOS LOGIC INPUTS					
Logic 1 Voltage @ DVDD_I/O (Pin 43) = 1.8 V	25°C	1.25			V
Logic 0 Voltage @ DVDD_I/O (Pin 43) = 1.8 V	25°C			0.6	V
Logic 1 Voltage @ DVDD_I/O (Pin 43) = 3.3 V	25°C	2.2			V
Logic 0 Voltage @ DVDD_I/O (Pin 43) = 3.3 V	25°C			0.8	V
Logic 1 Current	25°C		3	12	μA
Logic 0 Current	25°C			12	μA
Input Capacitance	25°C		2		pF
CMOS LOGIC OUTPUTS (1 mA Load) DVDD_I/O = 1.8 V					
Logic 1 Voltage	25°C	1.35			V
Logic 0 Voltage	25°C			0.4	V
CMOS LOGIC OUTPUTS (1 mA Load) DVDD_I/O = 3.3 V					
Logic 1 Voltage	25°C	2.8			V
Logic 0 Voltage	25°C			0.4	V
POWER CONSUMPTION (AVDD = DVDD = 1.8 V)					
Single-Tone Mode	25°C		162	171	mW
Rapid Power-Down Mode	25°C		150	160	mW
Full-Sleep Mode	25°C		20	27	mW
SYNCHRONIZATION FUNCTION <sup>8</sup>					
Maximum SYNC Clock Rate (DVDD_I/O = 1.8 V)	25°C	62.5			MHz
Maximum SYNC Clock Rate (DVDD_I/O = 3.3 V)	25°C	100			MHz
SYNC_CLK Alignment Resolution <sup>9</sup>	25°C		±1		SYSCLK cycles

<sup>1</sup> To achieve the best possible phase noise, the largest amplitude clock possible should be used. Reducing the clock input amplitude reduces the phase noise performance of the device.

<sup>2</sup> Represents the cycle-to-cycle residual jitter from the comparator alone.

<sup>3</sup> Represents the cycle-to-cycle residual jitter from the DDS core driving the comparator.

<sup>4</sup> The maximum frequency of the serial I/O port refers to the maximum speed of the port during a write operation. During a register readback, the maximum port speed is restricted to 2 Mbps.

<sup>5</sup> Setup time refers to the TCSU (setup time of the falling edge of  $\overline{CS}$  to the SCLK rising edge) and TDSU (setup time of the data change on SDIO to the SCLK rising edge).

<sup>6</sup> Wake-up time refers to the recovery from analog power-down modes (see the Power-Down Functions section). The longest time required is for the reference clock multiplier PLL to relock to the reference. The wake-up time assumes there is no capacitor on DACBP and that the recommended PLL loop filter values are used.

<sup>7</sup> SYSCLK cycle refers to the actual clock frequency used on-chip by the DDS. If the reference clock multiplier is used to multiply the external reference clock frequency, the SYSCLK frequency is the external frequency multiplied by the reference clock multiplication factor. If the reference clock multiplier is not used, the SYSCLK frequency is the same as the external reference clock frequency.

<sup>8</sup> SYNC\_CLK = ¼ SYSCLK rate. For SYNC\_CLK rates  $\geq$  50 MHz, the high speed sync enable bit, CFR2 [11], should be set.

<sup>9</sup> This parameter indicates that the digital synchronization feature cannot overcome phase delays (timing skew) between system clock rising edges. If the system clock edges are aligned, the synchronization function should not increase the skew between the two edges.

## ABSOLUTE MAXIMUM RATINGS

Table 2.

Parameter	Rating
Maximum Junction Temperature	150°C
DVDD_I/O	4 V
AVDD, DVDD	2 V
Digital Input Voltage (DVDD_I/O = 3.3 V)	-0.7 V to +5.25 V
Digital Input Voltage (DVDD_I/O = 1.8 V)	-0.7 V to +2.2 V
Digital Output Current	5 mA
Storage Temperature Range	-65°C to +150°C
Operating Temperature Range	-40°C to +105°C
Lead Temperature (10 sec Soldering)	300°C
$\theta_{JA}$	38°C/W
$\theta_{JC}$	15°C/W

Stresses above those listed under Absolute Maximum Ratings may cause permanent damage to the device. This is a stress rating only; functional operation of the device at these or any other conditions above those indicated in the operational section of this specification is not implied. Exposure to absolute maximum rating conditions for extended periods may affect device reliability.

### ESD CAUTION

ESD (electrostatic discharge) sensitive device. Electrostatic charges as high as 4000 V readily accumulate on the human body and test equipment and can discharge without detection. Although this product features proprietary ESD protection circuitry, permanent damage may occur on devices subjected to high energy electrostatic discharges. Therefore, proper ESD precautions are recommended to avoid performance degradation or loss of functionality.



## PIN CONFIGURATION AND FUNCTION DESCRIPTIONS

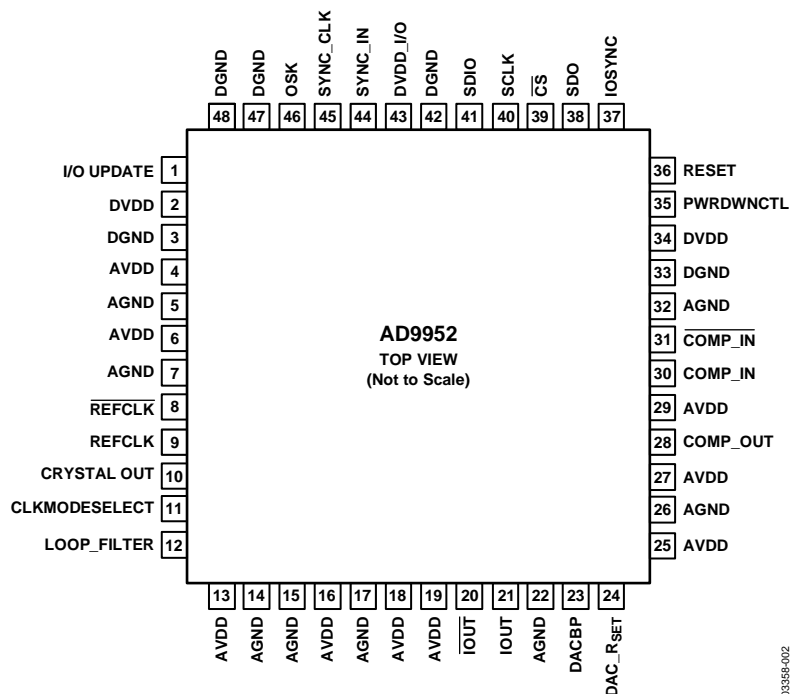

Figure 2. Pin Configuration

Note that the exposed paddle on the bottom of the package is a ground connection for the DAC and must be attached to AGND in any board layout. Note that Pin 43, DVDD\_I/O, can be powered to 1.8 V or 3.3 V; however, the DVDD pins (Pin 2 and Pin 34) can only be powered to 1.8 V.

Table 3. 48-Lead TQFP/EP

Pin No.	Mnemonic	I/O	Description
1	I/O UPDATE	I	The rising edge transfers the contents of the internal buffer memory to the I/O registers. This pin must be set up and held around the SYNC_CLK output signal.
2, 34	DVDD	I	Digital Power Supply Pins (1.8 V).
3, 33, 42, 47, 48	DGND	I	Digital Power Ground Pins.
4, 6, 13, 16, 18, 19, 25, 27, 29	AVDD	I	Analog Power Supply Pins (1.8 V).
5, 7, 14, 15, 17, 22, 26, 32	AGND	I	Analog Power Ground Pins.
8	$\overline{\text{REFCLK}}$	I	Complementary Reference Clock/Oscillator Input. When the REFCLK port is operated in single-ended mode, $\overline{\text{REFCLK}}$ should be decoupled to AVDD with a 0.1 $\mu\text{F}$ capacitor.
9	REFCLK	I	Reference Clock/Oscillator Input. See the Clock Input section for details on the oscillator/REFCLK operation.
10	CRYSTAL OUT	O	Output of the Oscillator Section.
11	CLKMODESELECT	I	Control Pin for the Oscillator Section. When high, the oscillator section is enabled. When low, the oscillator section is bypassed.
12	LOOP_FILTER	I	This pin provides the connection for the external zero compensation network of the REFCLK multiplier's PLL loop filter. The network consists of a 1 k $\Omega$ resistor in series with a 0.1 $\mu\text{F}$ capacitor tied to AVDD.
20	$\overline{\text{IOUT}}$	O	Complementary DAC Output. Should be biased through a resistor to AVDD, not AGND.
21	IOUT	O	DAC Output. Should be biased through a resistor to AVDD, not AGND.

# AD9952

Pin No.	Mnemonic	I/O	Description
23	DACBP	I	DAC Biasline Decoupling Pin. A 0.1 $\mu$ F capacitor to AGND is recommended.
24	DAC_R <sub>SET</sub>	I	A resistor (3.92 k $\Omega$ nominal) connected from AGND to DAC_R <sub>SET</sub> establishes the reference current for the DAC.
28	COMP_OUT	O	Comparator Output.
30	COMP_IN	I	Comparator Input.
31	$\overline{\text{COMP\_IN}}$	I	Comparator Complementary Input.
35	PWRDWNCTL	I	Input Pin Used as an External Power-Down Control. See Table 7 for additional information.
36	RESET	I	Active High Hardware Reset Pin. Assertion of the RESET pin forces the AD9952 to the initial state, as described in the I/O port register map (see Table 5).
37	IOSYNC	I	Asynchronous Active High Reset of the Serial Port Controller. When high, the current I/O operation is immediately terminated, enabling a new I/O operation to commence once IOSYNC is returned low. If unused, ground this pin; do not allow this pin to float.
38	SDO	O	When operating the I/O port as a 3-wire serial port, this pin serves as the serial data output. When operated as a 2-wire serial port, this pin is unused and can be left unconnected.
39	$\overline{\text{CS}}$	I	This pin functions as an active low chip select that allows multiple devices to share the I/O bus.
40	SCLK	I	This pin functions as the serial data clock for I/O operations.
41	SDIO	I/O	When operating the I/O port as a 3-wire serial port, this pin serves as the serial data input only. When operated as a 2-wire serial port, this pin is the bidirectional serial data pin.
43	DVDD_I/O	I	Digital Power Supply. For I/O cells only, 3.3 V.
44	SYNC_IN	I	Input signal used to synchronize multiple AD9952s. This input is connected to the SYNC_CLK output of a master AD9952.
45	SYNC_CLK	O	Clock output pin that serves as a synchronizer for external hardware.
46	OSK	I	Input pin used to control the direction of the shaped on-off keying function when programmed for operation. OSK is synchronous to the SYNC_CLK pin. When OSK is not programmed, this pin should be tied to DGND.
Paddle	Exposed Paddle	I	The exposed paddle on the bottom of the package is a ground connection for the DAC and must be attached to AGND in any board layout. Note that Pin 43, DVDD_I/O, can be powered to 1.8 V or 3.3 V; however, the DVDD pins (Pin 2 and Pin 34) can only be powered to 1.8 V.



# TYPICAL PERFORMANCE CHARACTERISTICS

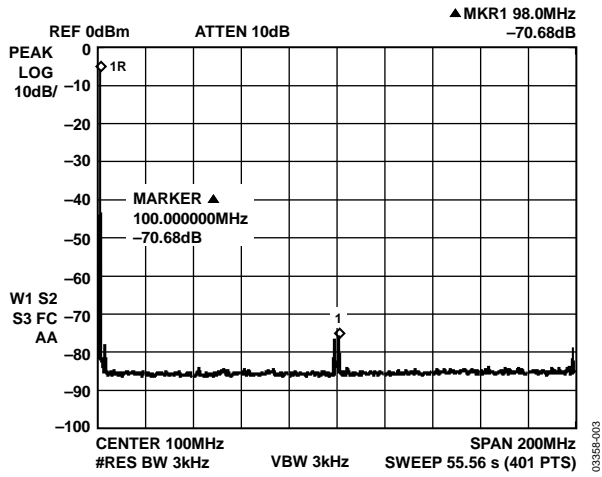

Figure 3.  $F_{OUT} = 1\text{ MHz}$ ,  $F_{CLK} = 400\text{ MSPS}$ , WBSFDR

03359-003

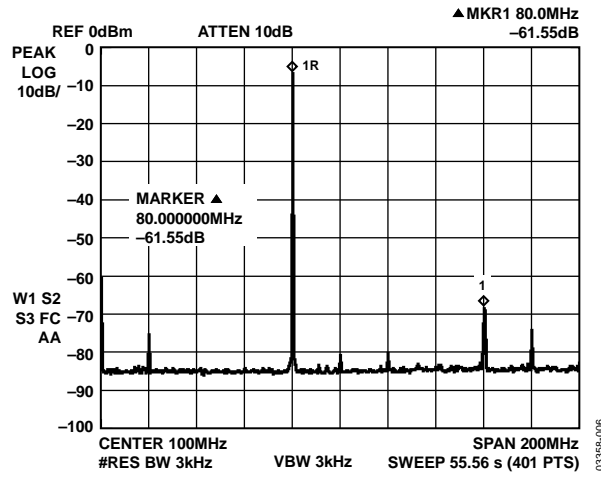

Figure 6.  $F_{OUT} = 80\text{ MHz}$ ,  $F_{CLK} = 400\text{ MSPS}$ , WBSFDR

03359-006

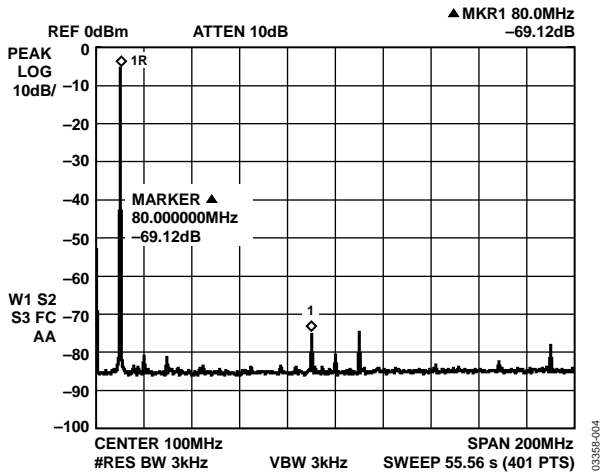

Figure 4.  $F_{OUT} = 10\text{ MHz}$ ,  $F_{CLK} = 400\text{ MSPS}$ , WBSFDR

03359-004

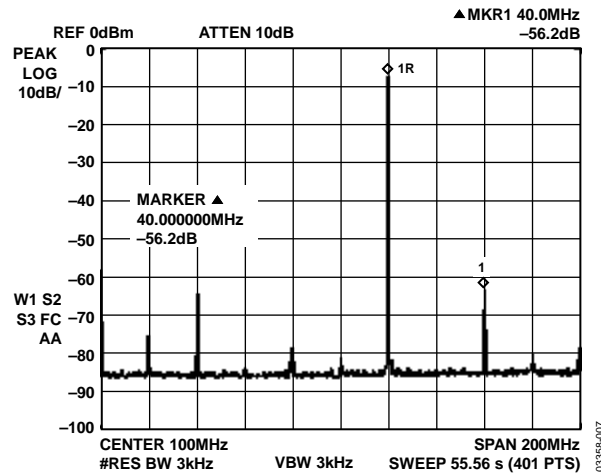

Figure 7.  $F_{OUT} = 120\text{ MHz}$ ,  $F_{CLK} = 400\text{ MSPS}$ , WBSFDR

03359-007

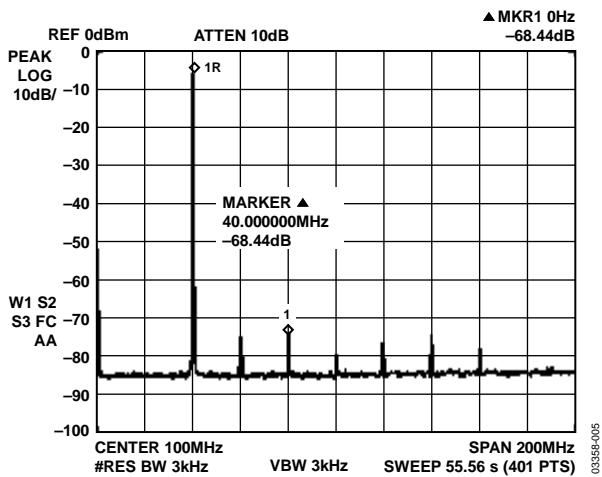

Figure 5.  $F_{OUT} = 40\text{ MHz}$ ,  $F_{CLK} = 400\text{ MSPS}$ , WBSFDR

03359-005

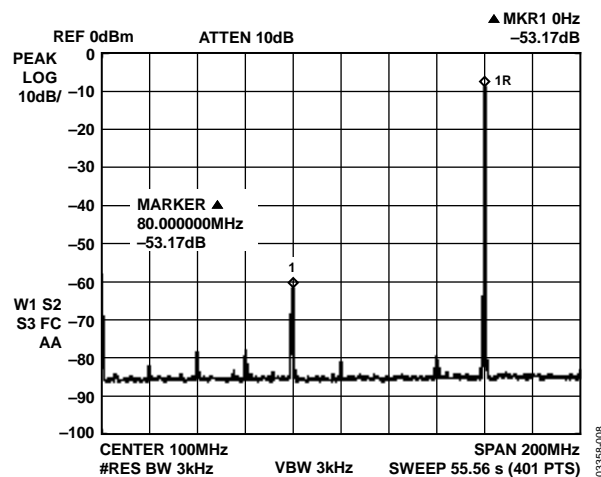

Figure 8.  $F_{OUT} = 160\text{ MHz}$ ,  $F_{CLK} = 400\text{ MSPS}$ , WBSFDR

03359-008

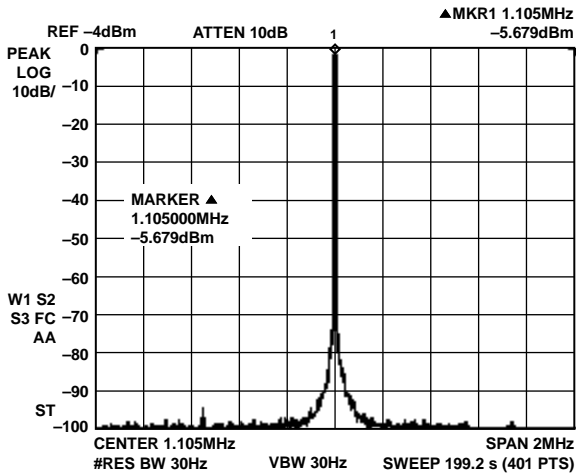

Figure 9.  $F_{OUT} = 1.1$  MHz,  $F_{CLK} = 400$  MSPS, NBSFDR,  $\pm 1$  MHz

03358-009

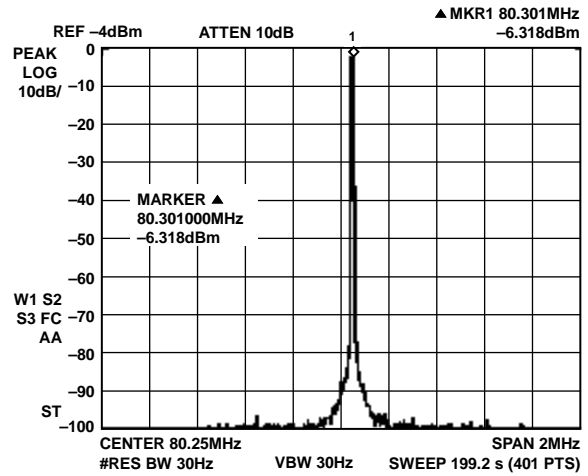

Figure 12.  $F_{OUT} = 80.3$  MHz,  $F_{CLK} = 400$  MSPS, NBSFDR,  $\pm 1$  MHz

03358-012

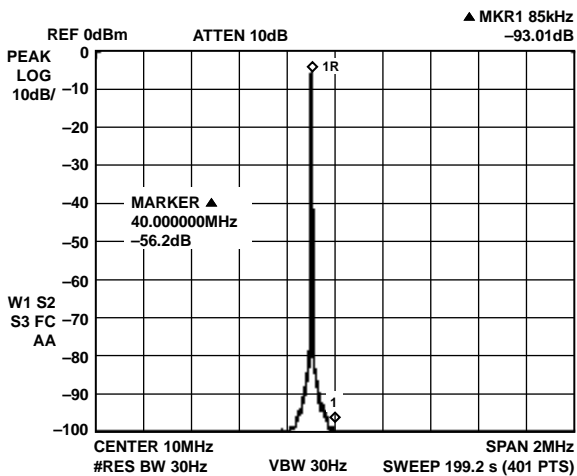

Figure 10.  $F_{OUT} = 10$  MHz,  $F_{CLK} = 400$  MSPS, NBSFDR,  $\pm 1$  MHz

03358-010

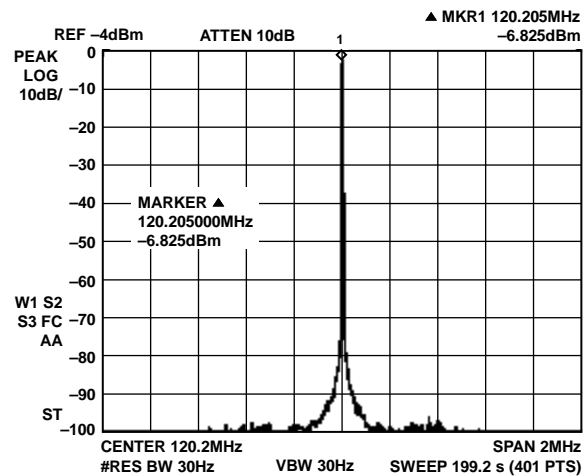

Figure 13.  $F_{OUT} = 120.2$  MHz,  $F_{CLK} = 400$  MSPS, NBSFDR,  $\pm 1$  MHz

03358-013

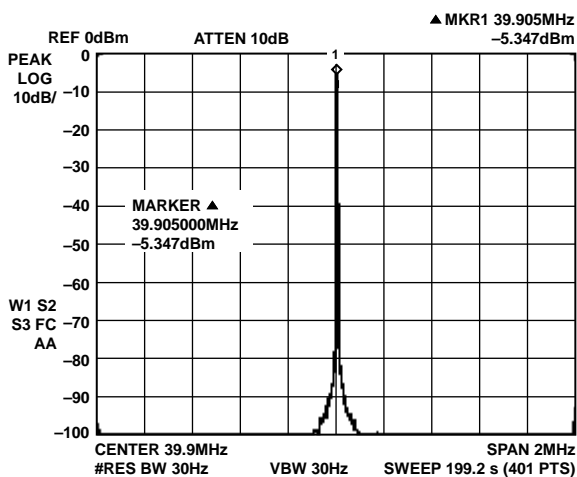

Figure 11.  $F_{OUT} = 39.9$  MHz,  $F_{CLK} = 400$  MSPS, NBSFDR,  $\pm 1$  MHz

03358-011

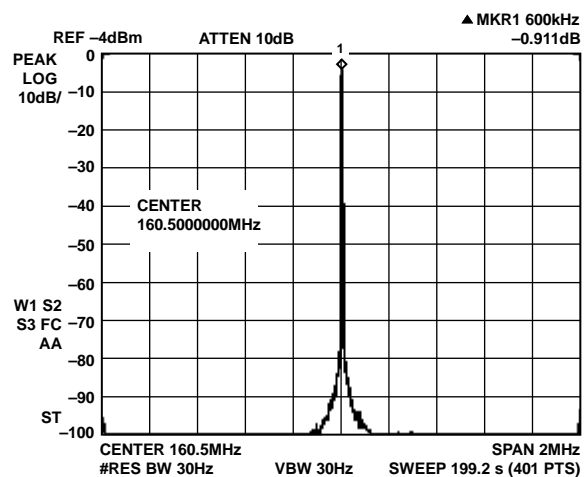

Figure 14.  $F_{OUT} = 160$  MHz,  $F_{CLK} = 400$  MSPS, NBSFDR,  $\pm 1$  MHz

03358-014

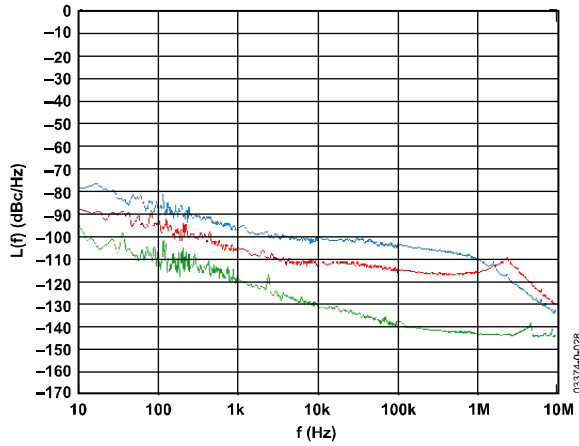

Figure 16. Residual Phase Noise with  $F_{OUT} = 159.5$  MHz,  $F_{CLK} = 400$  MSPS (Green),  $4 \times 100$  MSPS (Red), and  $20 \times 20$  MSPS (Blue)

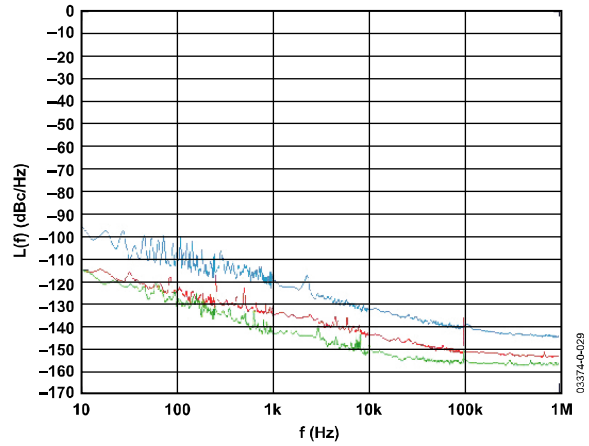

Figure 18. Residual Phase Noise with  $F_{OUT} = 9.5$  MHz,  $F_{CLK} = 400$  MSPS (Green),  $4 \times 100$  MSPS (Red), and  $20 \times 20$  MSPS (Blue)

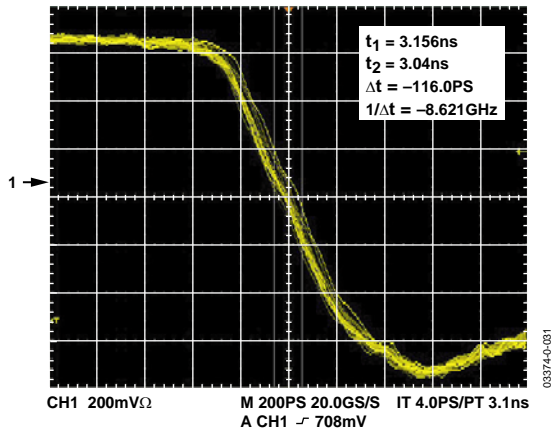

Figure 17. Residual Peak-to-Peak Jitter of DDS and Comparator Operating Together at 160 MHz

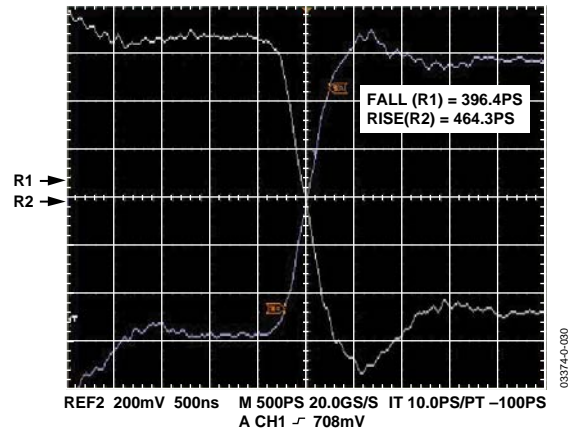
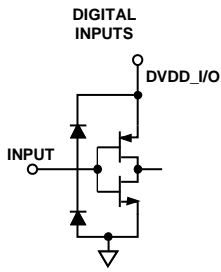

Figure 19. Comparator Rise and Fall Time at 160 MHz

# EQUIVALENT INPUT/OUTPUT CIRCUITS



AVOID OVERDRIVING DIGITAL INPUTS. FORWARD-BIASING ESD DIODES MAY COUPLE DIGITAL NOISE ONTO POWER PINS.

Figure 19. Digital Inputs

03358-019

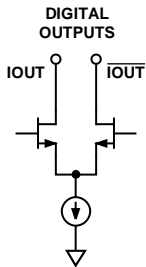

MUST TERMINATE OUTPUTS TO AVDD FOR CURRENT FLOW. DO NOT EXCEED THE OUTPUT VOLTAGE COMPLIANCE RATING.

Figure 20. DAC Outputs

03358-020

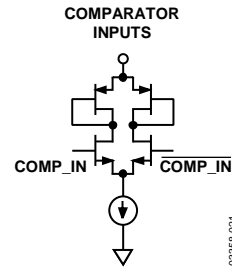

Figure 21. Comparator Inputs

03358-021

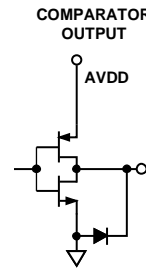

Figure 22. Comparator Outputs

03358-022

## THEORY OF OPERATION

### COMPONENT BLOCKS

#### DDS Core

The output frequency ( $f_o$ ) of the DDS is a function of the frequency of the system clock (SYSCLK), the value of the frequency tuning word (FTW), and the capacity of the accumulator ( $2^{32}$ , in this case). The exact relationship is given below with  $f_s$  defined as the frequency of SYSCLK.

$$f_o = (FTW)(f_s)/2^{32} \text{ with } 0 \leq FTW \leq 2^{31}$$

$$f_o = f_s \times (1 - (FTW/2^{32})) \text{ with } 2^{31} < FTW < 2^{32} - 1$$

The value at the output of the phase accumulator is translated to an amplitude value via the COS(x) functional block and routed to the DAC.

To introduce a phase offset, the phase offset word, or POW, is used. The actual phase offset,  $\Phi$  for the output of the DDS core, is determined by the following relationship:

$$\Phi = 360 \frac{POW}{2^{14}}$$

In certain applications, it is desirable to force the output signal to zero phase. Setting the FTW or POW to 0 does not accomplish this; it only results in the DDS core holding its current phase value or continuing to run at the current phase, respectively. To set the phase offset to zero, a control bit is required to force the phase accumulator output to zero. The bits to clear the phase accumulator are found in Control Function Register 1, Bit [13] and Bit [8].

At power-up, the clear phase accumulator bit is set to Logic 1, but the buffer memory for this bit is cleared (Logic 0). Therefore, upon power-up, the phase accumulator remains clear until the first I/O UPDATE is issued.

#### Phase-Locked Loop (PLL)

The PLL allows multiplication of the REFCLK frequency. Control of the PLL is accomplished by programming the 5-bit REFCLK multiplier portion of Control Function Register 2 (CFR2), Bits [7:3].

When programmed for values ranging from 0x04 to 0x14 (4 decimal to 20 decimal), the PLL multiplies the REFCLK input frequency by the corresponding decimal value. However, the maximum output frequency of the PLL is restricted to 400 MHz. Whenever the PLL value is changed, the user should be aware that time must be allocated to allow the PLL to lock (approximately 1 ms).

The PLL is bypassed by programming a value outside the range of 4 (decimal) to 20 (decimal). When bypassed, the PLL is shut down to conserve power.

#### Clock Input

The AD9952 supports various clock methodologies. Support for differential or single-ended input clocks and enabling of an on-chip oscillator and/or a PLL multiplier is all controlled via user-programmable bits. The AD9952 can be configured in one of six operating modes to generate the system clock. The modes are configured using the CLKMODESELECT pin, Control Function Register 1 (CFR1) [4], and CFR2 [7:3]. Connect the CLKMODESELECT external pin to logic high to enable the on-chip crystal oscillator circuit. With the on-chip oscillator enabled, connect an external crystal to the REFCLK and REFCLKB inputs to produce a low frequency reference clock in the range of 20 MHz to 30 MHz. The signal generated by the oscillator is buffered before it is delivered to the rest of the chip. This buffered signal is available via the CRYSTAL OUT pin. CFR1 [4] can be used to enable or disable the buffer, turning on or turning off the system clock. The oscillator itself is not powered down to avoid long start-up times associated with turning on a crystal oscillator. Writing CFR2 [9] to logic high enables the crystal oscillator output buffer. Logic low at CFR2 [9] disables the oscillator output buffer.

Connecting CLKMODESELECT to logic low disables the on-chip oscillator and the oscillator output buffer. With the oscillator disabled, an external oscillator must provide the REFCLK and/or REFCLKB signals. For differential operation, these pins are driven with complementary signals. For single-ended operation, a 0.1  $\mu$ F capacitor should be connected between the unused pin and the analog power supply. With the capacitor in place, the clock input pin bias voltage is 1.35 V. In addition, the PLL can be used to multiply the reference frequency by an integer value in the range of 4 (decimal) to 20 (decimal). Table 4 summarizes the clock modes of operation. Note that the PLL multiplier is controlled via CFR2 [7:3], independent of CFR1 [4].

**Table 4. Clock Input Modes of Operation**

CFR1 [4]	CLKMODESELECT	CFR2 [7:3]	Oscillator Enabled	System Clock	Frequency Range (MHz)
Low	High	$3 < M < 21$	Yes	$F_{CLK} = F_{OSC} \times M$	$80 < F_{CLK} < 400$
Low	High	$M < 4$ or $M > 20$	Yes	$F_{CLK} = F_{OSC}$	$20 < F_{CLK} < 30$
Low	Low	$3 < M < 21$	No	$F_{CLK} = F_{OSC} \times M$	$80 < F_{CLK} < 400$
Low	Low	$M < 4$ or $M > 20$	No	$F_{CLK} = F_{OSC}$	$10 < F_{CLK} < 400$
High	X	X	No	$F_{CLK} = 0$	N/A

## DAC Output

The AD9952 incorporates an integrated 14-bit current output DAC. Unlike most DACs, this output is referenced to AVDD, not AGND.

Two complementary outputs provide a combined full-scale output current ( $I_{OUT}$ ). Differential outputs reduce the amount of common-mode noise that might be present at the DAC output, offering the advantage of an increased signal-to-noise ratio. The full-scale current is controlled by an external resistor ( $R_{SET}$ ) connected between the DAC\_ $R_{SET}$  pin and the DAC ground (AGND\_DAC). The full-scale current is proportional to the resistor value as follows:

$$R_{SET} = 39.19 / I_{OUT}$$

The maximum full-scale output current of the combined DAC outputs is 15 mA, but limiting the output to 10 mA provides the best spurious-free dynamic range (SFDR) performance. The DAC output compliance range is AVDD + 0.5 V to AVDD – 0.5 V. Voltages developed beyond this range cause excessive DAC distortion and could potentially damage the DAC output circuitry. Proper attention should be paid to the load termination to keep the output voltage within this compliance range.

## Comparator

Many applications require a square wave signal rather than a sine wave. For example, in most clocking applications a high slew rate helps to reduce phase noise and jitter. To support these applications, the AD9952 includes an on-chip comparator. The comparator has a bandwidth greater than 200 MHz and a common-mode input range of 1.3 V to 1.8 V. By setting the comparator power-down bit, CFR1 [6], the comparator can be turned off to save on power consumption.

## Serial I/O Port

The AD9952 serial port is a flexible, synchronous serial communications port that allows easy interface to many industry-standard microcontrollers and microprocessors. The serial I/O port is compatible with most synchronous transfer formats, including both the Motorola 6905/11 SPI® and Intel® 8051 SSR protocols.

The interface allows read/write access to all registers that configure the AD9952. MSB first or LSB first transfer formats are supported. The AD9952 serial interface port can be configured as a single pin I/O (SDIO) that allows a 2-wire interface or two unidirectional pins for in/out (SDIO/SDO), which in turn enable a 3-wire interface. Two optional pins, IOSYNC and  $\overline{CS}$ , enable greater flexibility for system design in the AD9952. Please see the Serial Port Operation section for details on how to program the AD9952 through the serial I/O port.

## Register Map and Descriptions

The register map is listed in Table 5.

Table 5. Register Map

Register Name (Serial Address)	Register Address	Bit Range	(MSB) Bit 7	Bit 6	Bit 5	Bit 4	Bit 3	Bit 2	Bit 1	(LSB) Bit 0	Default Value
Control Function Register 1 (CFR1)	(0x00)	[7:0]	Digital Power-Down	Comparator Power-Down	DAC Power-Down	Clock Input Power-Down	External Power-Down Mode	Not Used	SYNC_CLK Out Disable	Not Used	0x00
		[15:8]	Not Used	Not Used	Auto Clr Phase Accum.	Enable SINE Output	Not Used	Clear Phase Accum.	SDIO Input Only	LSB First	0x00
		[23:16]	Automatic Sync Enable	Software Manual Sync	Not Used						0x00
		[31:24]	Not Used					Load ARR @ I/O UPDATE	OSK Enable	Auto OSK Keying	0x00
Control Function Register 2 (CFR2)	(0x01)	[7:0]	REFCLK Multiplier 0x00 or 0x01, or 0x02 or 0x03: Bypass Multiplier 0x04 to 0x14: 4x to 20x Multiplication				VCO Range	Charge Pump Current [1:0]		0x00	
		[15:8]	Not Used			High Speed Sync Enable	Hardware Manual Sync Enable	CRYSTAL OUT Pin Active	Not Used	0x00	
		[23:16]	Not Used								0x18
Amplitude Scale Factor (ASF)	(0x02)	[7:0]	Amplitude Scale Factor Register [7:0]								0x00
		[15:8]	Auto Ramp Rate Speed Control [1:0]	Amplitude Scale Factor Register [13:8]							0x00
Amplitude Ramp Rate (ARR)	(0x03)	[7:0]	Amplitude Ramp Rate Register [7:0]								0x00
Frequency Tuning Word 0 (FTW0)	(0x04)	[7:0]	Frequency Tuning Word 0 [7:0]								0x00
		[15:8]	Frequency Tuning Word 0 [15:8]								0x00
		[23:16]	Frequency Tuning Word 0 [23:16]								0x00
		[31:24]	Frequency Tuning Word 0 [31:24]								0x00
Phase Offset Word (POW)	(0x05)	[7:0]	Phase Offset Word 0 [7:0]								0x00
		[15:8]	Not Used [1:0]	Phase Offset Word 0 [13:8]						0x00	

## CONTROL REGISTER BIT DESCRIPTIONS

### Control Function Register 1 (CFR1)

The CFR1 bits control the functions, features, and modes of the AD9952. The functionality of each bit is detailed below.

#### CFR1 [31:27]: Not Used

#### CFR1 [26]: Amplitude Ramp Rate Load Control Bit

CFR1 [26] = 0 (default). The amplitude ramp rate timer is loaded only upon timeout (timer = 1) and is not loaded due to an I/O UPDATE input signal.

CFR1 [26] = 1. The amplitude ramp rate timer is loaded upon timeout (timer = 1) or at the time of an I/O UPDATE input signal.

#### CFR1 [25]: Shaped On-Off Keying Enable Bit

CFR1 [25] = 0 (default). Shaped on-off keying is bypassed.

CFR1 [25] = 1. Shaped on-off keying is enabled. When enabled, CFR1 [24] controls the mode of operation for this function.

#### CFR1 [24]: Auto Shaped On-Off Keying Enable Bit (only valid when CFR1[25] is active high)

CFR1 [24] = 0 (default). When CFR1[25] is active, a Logic 0 on CFR1[24] enables the manual shaped on-off keying operation. Each amplitude sample sent to the DAC is multiplied by the amplitude scale factor. See the Shaped On-Off Keying section for details.

CFR1 [24] = 1. When CFR1[25] is active, a Logic 1 on CFR1 [24] enables the auto shaped on-off keying operation. Toggling the OSK pin high causes the output scalar to ramp up from zero scale to the amplitude scale factor at a rate determined by the amplitude ramp rate. Toggling the OSK pin low causes the output to ramp down from the amplitude scale factor to zero scale at the amplitude ramp rate (see the Shaped On-Off Keying section).

#### CFR1 [23]: Automatic Synchronization Enable Bit

CFR1 [23] = 0 (default). The automatic synchronization feature of multiple AD9952s is inactive.

CFR1 [23] = 1. The automatic synchronization feature of multiple AD9952s is active. The device synchronizes its internal synchronization clock (SYNC\_CLK) to align to the signal present on the SYNC\_IN input (see the Synchronizing Multiple AD9952 section).

#### CFR1 [22]: Software Manual Synchronization of Multiple AD9952s

CFR1 [22] = 0 (default). The manual synchronization feature is inactive.

CFR1 [22] = 1. The software controlled manual synchronization feature is executed. The SYNC\_CLK rising edge is advanced by one SYNC\_CLK cycle and this bit is cleared. To advance the rising edge multiple times, this bit needs to be set for each advance (see the Synchronizing Multiple AD9952 section).

#### CFR1 [21:14]: Not Used

#### CFR1 [13]: Auto-Clear Phase Accumulator Bit

CFR1 [13] = 0 (default). The current state of the phase accumulator remains unchanged when the frequency tuning word is applied.

CFR1 [13] = 1. This bit synchronously clears the phase accumulator automatically (by loadings 0s) for one cycle upon reception of an I/O UPDATE signal.

#### CFR1 [12]: Sine/Cosine Select Bit

CFR1 [12] = 0 (default). The angle-to-amplitude conversion logic employs a COSINE function.

CFR1 [12] = 1. The angle-to-amplitude conversion logic employs a SINE function.

#### CFR1 [11]: Not Used

#### CFR1 [10]: Clear Phase Accumulator

CFR1 [10] = 0 (default). The phase accumulator functions as normal.

CFR1 [10] = 1. The phase accumulator memory elements are cleared and held clear until this bit is cleared.

#### CFR1 [9]: SDIO Input Only

CFR1 [9] = 0 (default). The SDIO pin has bidirectional operation (2-wire serial programming mode).

CFR1 [9] = 1. The serial data I/O pin (SDIO) is configured as an input only pin (3-wire serial programming mode).

#### CFR1 [8]: LSB First

CFR1 [8] = 0 (default). MSB first format is active.

CFR1 [8] = 1. The serial interface accepts serial data in LSB-first format.

#### CFR1 [7]: Digital Power-Down Bit

CFR1 [7] = 0 (default). All digital functions and clocks are active.

CFR1 [7] = 1. All non-I/O digital functionality is suspended, lowering the power significantly.



**CFR1 [6]: Comparator Power-Down Bit**

CFR1 [6] = 0 (default). The comparator is enabled for operation.

CFR1 [6] = 1. The comparator is disabled and is in its lowest power dissipation state.

**CFR1 [5]: DAC Power-Down Bit**

CFR1 [5] = 0 (default). The DAC is enabled for operation.

CFR1 [5] = 1. The DAC is disabled and is in its lowest power dissipation state.

**CFR1 [4]: Clock Input Power-Down Bit**

CFR1 [4] = 0 (default). The clock input circuitry is enabled for operation.

CFR1 [4] = 1. The clock input circuitry is disabled and the device is in its lowest power dissipation state.

**CFR1 [3]: External Power-Down Mode**

CFR1 [3] = 0 (default). Selects the external rapid recovery power-down mode. In this mode, when the PWRDWNCTL input pin is high, the digital logic and the DAC digital logic are powered down. The DAC bias circuitry, PLL, oscillator, and clock input circuitry are not powered down.

CFR1 [3] = 1. Selects the external full power-down mode. In this mode, when the PWRDWNCTL input pin is high, all functions are powered down. This includes the DAC and PLL, which take a significant amount of time to power up.

**CFR1 [2]: Not Used****CFR1 [1]: SYNC\_CLK Disable Bit**

CFR1 [1] = 0 (default). The SYNC\_CLK pin is active.

CFR1 [1] = 1. The SYNC\_CLK pin assumes a static Logic 0 state to keep noise generated by the digital circuitry at a minimum. However, the synchronization circuitry remains active (internally) to maintain normal device timing.

**CFR1 [0]: Not Used, Leave at 0****Control Function Register 2 (CFR2)**

The CFR2 bits control the functions, features, and modes of the AD9952, primarily related to the analog sections of the chip.

**CFR2 [23:12]: Not Used****CFR2 [11]: High Speed Sync Enable Bit**

CFR2 [11] = 0 (default). The high speed sync enhancement is off.

CFR2 [11] = 1. The high speed sync enhancement is on. This bit should be set when using the autosynchronization feature for SYNC\_CLK inputs beyond 50 MHz, (200 MSPS SYSCLK). See the Synchronizing Multiple AD9952S section.

**CFR2 [10]: Hardware Manual Sync Enable Bit**

CFR2 [10] = 0 (default). The hardware manual sync function is off.

CFR2 [10] = 1. The hardware manual sync function is enabled. While this bit is set, a rising edge on the SYNC\_IN pin causes the device to advance the SYNC\_CLK rising edge by one REFCLK cycle. Unlike the software manual sync enable bit, this bit does not self-clear. Once the hardware manual sync mode is enabled, it stays enabled until this bit is cleared (see the Synchronizing Multiple AD9952 section).

**CFR2 [9]: CRYSTAL OUT Enable Bit**

CFR2 [9] = 0 (default). The CRYSTAL OUT pin is inactive.

CFR2 [9] = 1. The CRYSTAL OUT pin is active. When active, the crystal oscillator circuitry output drives the CRYSTAL OUT pin, which can be connected to other devices to produce a reference frequency. The oscillator responds to crystals in the range of 20 MHz to 30 MHz.

**CFR2 [8]: Not Used****CFR2 [7:3]: Reference Clock Multiplier Control Bits**

This 5-bit word controls the multiplier value out of the clock-multiplier (PLL) block. Valid values are 4 decimal to 20 decimal (0x04 to 0x14). Values entered outside this range bypass the clock multiplier. See the Phase-Locked Loop (PLL) section.

**CFR2 [2]: VCO Range Control Bit**

This bit is used to control the range setting on the VCO. CFR2 [2] = 0 (default). The VCO operates in a range of 100 MHz to 250 MHz.

CFR2 [2] = 1. The VCO operates in a range of 250 MHz to &" MHz.

**CFR2 [1:0]: Charge Pump Current Control Bits**

These bits are used to control the current setting on the charge pump. The default setting, CFR2 [1:0], sets the charge pump current to the default value of 75  $\mu$ A. For each bit added (Bit 01, Bit 10, and Bit 11), 25  $\mu$ A of current is added to the charge pump current: 100  $\mu$ A, 125  $\mu$ A, and 150  $\mu$ A.

## OTHER REGISTER DESCRIPTIONS

### **Amplitude Scale Factor (ASF)**

The ASF register stores the 2-bit auto ramp rate speed value and the 14-bit amplitude scale factor used in the output shaped keying (OSK) operation. In auto OSK operation, ASF [15:14] tell the OSK block how many amplitude steps to take for each increment or decrement. ASF [13:0] sets the maximum value for the OSK internal multiplier. In manual OSK mode, ASF [15:14] have no effect. ASF [13:0] provide the output scale factor directly. If the OSK enable bit is cleared, CFR1 [25] = 0, this register has no effect on device operation.

### **Amplitude Ramp Rate (ARR)**

The ARR register stores the 8-bit amplitude ramp rate used in the auto OSK mode. This register programs the rate at which the amplitude scale factor counter increments or decrements. If the OSK is set to manual mode, or if OSK enable is cleared, this register has no effect on device operation.

### **Frequency Tuning Word 0 (FTW0)**

The frequency tuning word is a 32-bit register that controls the rate of accumulation in the phase accumulator of the DDS core. Its specific role depends on the device mode of operation.

### **Phase Offset Word (POW)**

The phase offset word is a 14-bit register that stores a phase offset value. This offset value is added to the output of the phase accumulator to offset the current phase of the output signal. The exact value of phase offset is given by the following formula:

$$\Phi = \left( \frac{POW}{2^{14}} \right) \times 360^\circ$$

Or

$$POW = \left( \frac{\Phi}{360^\circ} \right) \times 2^{14}$$

where  $\Phi$  is the desired phase offset, in degrees.

## MODES OF OPERATION

### **Single-Tone Mode**

In single-tone mode, the DDS core uses a single tuning word. Whatever value is stored in FTW0 is supplied to the phase accumulator. This value can only be changed manually, which is done by writing a new value to FTW0 and by issuing an I/O UPDATE. Phase adjustment is possible through the phase offset register.

## PROGRAMMING FEATURES

### **Phase Offset Control**

A 14-bit phase offset ( $\theta$ ) can be added to the output of the phase accumulator by means of the control registers. This feature provides the user with two different methods of phase control.

The first method is a static phase adjustment, where a fixed phase offset is loaded into the appropriate phase offset register and left unchanged. The result is that the output signal is offset by a constant angle relative to the nominal signal. This allows the user to phase align the DDS output with some external signal, if necessary.

In the second method of phase control, the user regularly updates the phase offset register via the I/O port. By properly modifying the phase offset as a function of time, the user can implement a phase modulated output signal. However, both the speed of the I/O port and the frequency of SYSCLK limit the rate at which phase modulation can be performed.

The AD9952 allows for a programmable continuous zeroing of the phase accumulator as well as a clear and release or automatic zeroing function. Each feature is individually controlled via the CFR1 bits. CFR1 [13] is the automatic clear phase accumulator bit. CFR1 [10] clears the phase accumulator and holds the value to 0.

### **Continuous Clear Bit**

The continuous clear bit is simply a static control signal that, when active high, holds the phase accumulator at 0 for the entire time the bit is active. When the bit goes low, inactive, the phase accumulator is allowed to operate.

### **Clear and Release Function**

When set, the auto-clear phase accumulator clears and releases the phase accumulator upon receiving an I/O UPDATE. The automatic clearing function is repeated for every subsequent I/O UPDATE until the appropriate auto-clear control bit is cleared.

### **Shaped On-Off Keying**

The shaped on-off keying function of the AD9952 allows the user to control the ramp-up and ramp-down time of an on-off emission from the DAC. This function is used in burst transmissions of digital data to reduce the adverse spectral impact of short, abrupt bursts of data.

Auto and manual shaped on-off keying modes are supported. The auto mode generates a linear scale factor at a rate determined by the amplitude ramp rate (ARR) register controlled by an external pin (OSK). Manual mode allows the user to directly control the output amplitude by writing the scale factor value into the amplitude scale factor (ASF) register.

The shaped on-off keying function can be bypassed (disabled) by clearing the OSK enable bit (CFR1 [25] = 0).

The modes are controlled by two bits located in the most significant byte of the control function register (CFR). CFR1 [25] is the shaped on-off keying enable bit. When CFR1 [25] is set, the output scaling function is enabled and CFR1 [25] bypasses the function. CFR1 [24] is the internal shaped on-off keying active bit. When CFR1 [24] is set, internal shaped on-off keying mode is active; when CFR1 [24] is cleared, external shaped on-off keying mode is active. CFR1 [24] is a don't care if the shaped on-off keying enable bit (CFR1 [25]) is cleared. The power-up condition of the shaped on-off keying is disabled (CFR1 [25] = 0). Figure 23 shows the block diagram of the OSK circuitry.

### Auto Shaped On-Off Keying Mode Operation

The auto shaped on-off keying mode is active when CFR1 [25] and CFR1 [24] are set. When auto shaped on-off keying mode is enabled, a single-scale factor is internally generated and applied to the multiplier input for scaling the output of the DDS core block (see Figure 23). The scale factor is the output of a 14-bit counter that increments/decrements at a rate determined by the contents of the 8-bit output ramp rate register. The scale factor increases if the OSK pin is high and decreases if the OSK pin is low. The scale factor is an unsigned value such that all 0s multiply the DDS core output by 0 (decimal) and 0x3FFF multiplies the DDS core output by 16,383 (decimal).

To use the full amplitude (14-bits) with fast ramp rates, the internally generated scale factor step size is controlled via the ASF [15:14]. Table 6 describes the increment/decrement step size of the internally generated scale factor per the ASF [15:14].

A special feature of this mode is that the maximum output amplitude allowed is limited by the contents of the amplitude scale factor register. This allows the user to ramp to a value less than full scale.

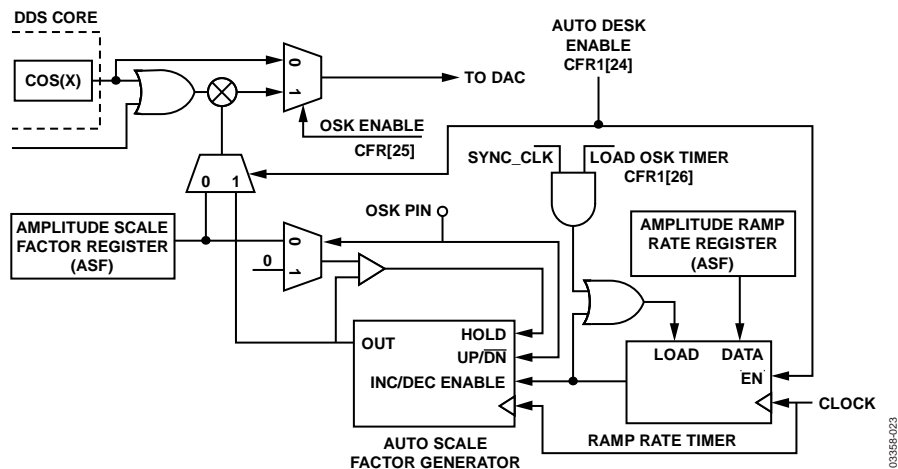

Figure 23. On-Off Shaped Keying, Block Diagram

Table 6. Auto Scale Factor Internal Step Size

ASF [15:14] (Binary)	Increment/Decrement Size
00	1
01	2
10	4
11	8

### OSK Ramp Rate Timer

The OSK ramp rate timer is a loadable down counter that generates the clock signal to the 14-bit counter, which, in turn, generates the internal scale factor. The ramp rate timer is loaded with the value of the ASFR every time the counter reaches 1 (decimal). This load and countdown operation continues for as long as the timer is enabled, unless the timer is forced to load before reaching a count of 1.

If the load OSK timer bit (CFR1 [26]) is set, the ramp rate timer is loaded upon an I/O UPDATE or upon reaching a value of 1. The ramp timer can be loaded before reaching a count of 1 by three methods.

The first method of loading is by changing the OSK input pin. When the OSK input pin changes state, the ASFR value is loaded into the ramp rate timer, which then proceeds to count down as normal.

The second method in which the sweep ramp rate timer can be loaded before reaching a count of 1 is if the load OSK timer bit (CFR1 [26]) is set and an I/O UPDATE is issued.

The last method in which the sweep ramp rate timer can be loaded before reaching a count of 1 is when going from the inactive auto shaped on-off keying mode to the active auto shaped on-off keying mode; that is, when the sweep enable bit is being set.

## External Shaped On-Off Keying Mode Operation

The external shaped on-off keying mode is enabled by writing CFR1 [25] to a Logic 1 and writing CFR1 [24] to a Logic 0. When configured for external shaped on-off keying, the content of the ASFR becomes the scale factor for the data path. The scale factors are synchronized to SYNC\_CLK via the I/O UPDATE functionality.

## SYNCHRONIZING MULTIPLE AD9952s

The AD9952 product allows easy synchronization of multiple AD9952s. There are three modes of synchronization available to the user: an automatic synchronization mode, a software controlled manual synchronization mode, and a hardware controlled manual synchronization mode. In all cases, to synchronize two or more devices, the following considerations must be observed. First, all units must share a common clock source. Trace lengths and path impedance of the clock tree must be designed to keep the phase delay of the different clock branches as closely matched as possible. Second, the I/O UPDATE signal's rising edge must be provided synchronously to all devices in the system. Finally, regardless of the internal synchronization method used, the DVDD\_I/O supply should be set to 3.3 V for all devices that are to be synchronized. AVDD and DVDD should be left at 1.8 V.

In automatic synchronization mode, one device is chosen as a master; the other devices are slaved to this master. When configured in this mode, the slaves automatically synchronize their internal clocks to the SYNC\_CLK output signal of the master device. To enter automatic synchronization mode, set the slave device's automatic synchronization bit (CFR1 [23] = 1). Connect the SYNC\_IN input(s) to the master SYNC\_CLK output. The slave device continuously updates the phase relationship of its SYNC\_CLK until it is in phase with the SYNC\_IN input, which is the SYNC\_CLK of the master device. When attempting to synchronize devices running at SYSCLK speeds beyond 250 MSPS, the high speed sync enhancement enable bit should be set (CFR2 [11] = 1).

In software manual synchronization mode, the user forces the device to advance the SYNC\_CLK rising edge one SYSCLK cycle ( $\frac{1}{4}$  SYNC\_CLK period). To activate the manual synchronization mode, set the slave device's software manual synchronization bit (CFR1 [22] = 1). The bit (CFR1 [22]) is cleared immediately. To advance the rising edge of the SYNC\_CLK multiple times, this bit needs to be set multiple times.

In hardware manual synchronization mode, the SYNC\_IN input pin is configured such that it advances the rising edge of the SYNC\_CLK signal each time the device detects a rising edge on the SYNC\_IN pin. To put the device into hardware manual synchronization mode, set the hardware manual synchronization bit (CFR2 [10] = 1). Unlike the software manual synchronization bit, this bit does not self-clear.

Once the hardware manual synchronization mode is enabled, all rising edges detected on the SYNC\_IN input cause the device to advance the rising edge of the SYNC\_CLK by one SYSCLK cycle until this enable bit is cleared (CFR2 [10] = 0).

## Using a Single Crystal to Drive Multiple AD9952 Clock Inputs

The AD9952 crystal oscillator output signal is available on the CRYSTAL OUT pin, enabling one crystal to drive multiple AD9952s. To drive multiple AD9952s with one crystal, the CRYSTAL OUT pin of the AD9952 using the external crystal should be connected to the REFCLK input of the other AD9952.

The CRYSTAL OUT pin is static until the CFR2 [9] bit is set, enabling the output. The drive strength of the CRYSTAL OUT pin is typically very low, so this signal should be buffered prior to using it to drive any loads.

## SERIAL PORT OPERATION

The operations of the AD9952 are controlled by setup data and parameters loaded into the device by means of a serial I/O port. The internal control structure is organized as a series of registers. Each register is double-buffered. New data is first stored in I/O buffers as it is received. Subsequently, the data is transferred to the internal registers that actually control the device operation. While the I/O buffers are receiving new data, the old data that is already in the control registers continues to be used until the I/O buffers are transferred into the control registers. The transfer from I/O buffer to control registers requires an I/O update event. This event is triggered by sending a pulse to the I/O UPDATE pin.

### Step 1: Writing Data Through the Serial I/O Port to the I/O Buffers

There are two phases to a serial I/O communication cycle:

- Phase 1: Instruction (one byte)
- Phase 2: Data (one or more bytes)

Phase 1 is the instruction byte, clocked in by the first eight rising edges of SCLK. This single byte provides the AD9952 serial port controller with the information that it needs regarding the upcoming data phase, Phase 2. This information tells the serial port controller whether the data is a read or a write operation, as well as the address of the intended register. Once the controller knows the register address, the number of bytes of data to be expected is calculated automatically.

The number of bytes transferred during Phase 2 depends on the particular register being accessed. For example, when the Control Function Register 2 is accessed, the data consists of three bytes (or 24 bits). However, if the Frequency Tuning Word 0 register is accessed, the data is four bytes (or 32 bits). Step 1 is complete when both the instruction byte and the required number of data bytes are written to or read from.

After the completion of Phase 2, the AD9952 serial port controller expects the next eight SCLK rising edges to be a new instruction byte, followed by an appropriate number of data bytes. See the Example Operation section of this document for details.

All data written into the serial port is clocked into the I/O buffer on the rising edge of SCLK. All data read back from the serial port is clocked out on the falling edge of SCLK. Note that the readback operation reads data from registers, not the I/O buffers. If new data has been written to an I/O buffer, but an I/O update has not occurred, the old data stored in the register is read back (see Step 2: Transfer of I/O Buffers to Registers). Also, the serial I/O port speed of 25 Mbps refers solely to the speed of SCLK during a write operation. As the AD9952 does not generate data, the readback operation is considered a debug feature and is not supported beyond 1 Mbps.

### Instruction Byte Details

The instruction byte contains the following information.

(MSB)								(LSB)
D7	D6	D5	D4	D3	D2	D1	D0	
R/ $\overline{W}$	X	X	A5	A4	A3	A2	A1	

$\overline{R/W}$ —Bit 7 of the instruction byte determines whether a read or write data transfer occurs after the instruction byte write. Logic High indicates a read operation; a Logic 0 indicates a write operation.

X, X—Bit 6 and Bit 5, respectively, of the instruction byte are don't care.

A5, A4, A3, A2, A1—Bit 4, Bit 3, Bit 2, Bit 1, and Bit 0, respectively, of the instruction byte determine which register is accessed during the data transfer portion of the communication cycle.

### Step 2: Transfer of I/O Buffers to Registers

When the desired setup data is written via the serial port to the I/O buffers, the registers must be updated by issuing an I/O update signal on the I/O UPDATE pin. The I/O update signal consists of a logic high pulse (DVDD\_I/O) on the I/O UPDATE pin.

As shown in Figure 24, the I/O update pulse is sampled synchronously by the AD9952 on the rising edge of SYNC\_CLK. Therefore, the I/O update pulse needs to be set up to the rising edge of the SYNC\_CLK signal.

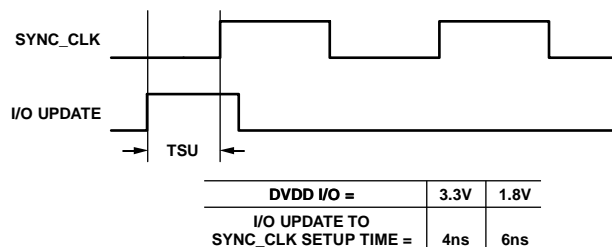

Figure 24. Setup Time for I/O Update Pulse for Synchronous Data Transfer

To transfer data without having to monitor the SYNC\_CLK signal and without having to guarantee setup time, an alternate method is to provide an I/O update pulse for more than one SYNC\_CLK period (more than four SYSCLK periods) asynchronously. If this is done, the I/O update pulse overlaps with at least one SYNC\_CLK rising edge. However, there is no guarantee of which SYNC\_CLK rising edge transfers the I/O buffer data to the registers. This method introduces an ambiguity of one SYNC\_CLK cycle (four SYSCLK cycles) in the calculation of the propagation delay and should be avoided if propagation delay of data transfers is an important consideration. This method is shown in Figure 25.

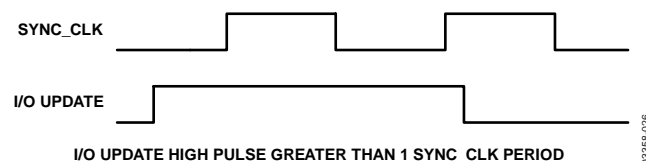
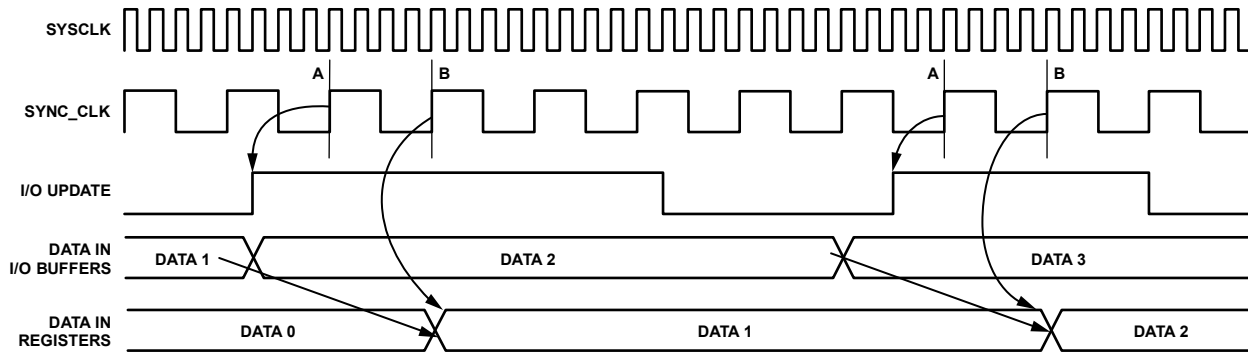

Figure 25. I/O Update Pulse in Asynchronous Data Transfer

It should be noted that the exact transfer of data from the I/O buffers to the registers actually occurs one SYNC\_CLK cycle after the I/O update signal is detected by the AD9952, as shown in Figure 26.



THE DEVICE REGISTERS AN I/O UPDATE AT POINT A. THE DATA IS TRANSFERRED FROM THE I/O BUFFERS AT POINT B.

Figure 26. Timing of I/O Update Signal vs. Actual Register Update

## Serial Interface Port Pin Description

**SCLK**—Serial Clock. The serial clock pin is used to synchronize data to and from the AD9952 and to run the internal state machines. SCLK maximum frequency is 25 MHz.

**$\overline{CS}$** —Chip Select Bar.  $\overline{CS}$  is active low input that allows more than one device on the same serial communication line. The SDO pin and SDIO pin go to a high impedance state when this input is high. If driven high during any communication cycle, the cycle is suspended until  $\overline{CS}$  is reactivated low. Chip select can be tied low in systems that maintain control of SCLK. When toggling  $\overline{CS}$ , it is important that care is taken to meet the clock setup time with respect to the falling edge of  $\overline{CS}$  and TCSU (see Figure 27).

**SDIO**—Serial Data I/O. Data is always written into the AD9952 on this pin. However, this pin can be used as a bidirectional data line. Bit 9 of Register 0x00 controls the configuration of this pin. The default is Logic 0, which configures the SDIO pin as bidirectional. In order to guarantee proper serial I/O port operation (see Figure 27), data on this pin must be set up and held to the rising edge of SCLK on read operations.

**SDO**—Serial Data Out. Data is read from this pin for protocols that use separate lines for transmitting and receiving data. In the case where the AD9952 operates in a single bidirectional I/O mode, this pin does not output data and is set to a high impedance state.

**IOSYNC**—Synchronizes the I/O port state machines without affecting the registers' contents. An active high input on the IOSYNC pin causes the current communication cycle to abort. After IOSYNC returns low (Logic 0), another communication cycle can begin, starting with the instruction byte write.

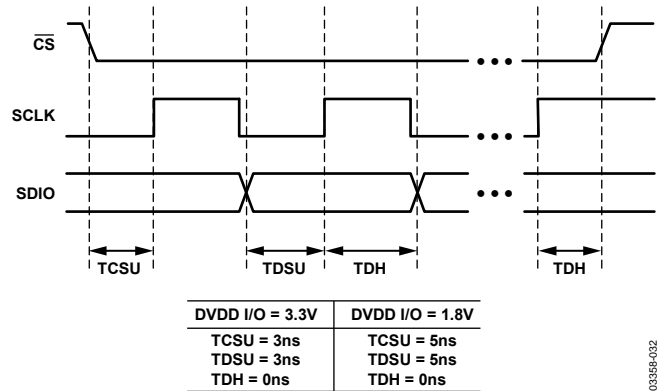

Figure 27. Serial Port I/O Setup (TCSU, TDSU) and Hold (TDH) Times

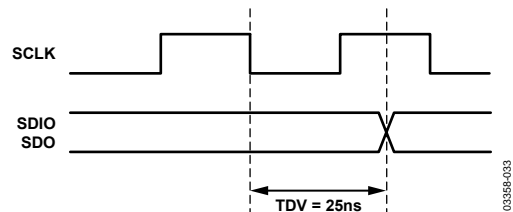

Figure 28. Serial Port I/O Data Valid Time (TDV) During Readback

## MSB/LSB Transfers

The AD9952 serial port can support both most significant bit (MSB) first or least significant bit (LSB) first data formats. The control register, Register 0x00, Bit 8, controls this functionality. The default value of Register 0x00 [8] is low (MSB first).

When the control register (0x00 [8]) is set high, the AD9952 serial port is in LSB-first format. The instruction byte must be written in the format indicated by the control register (0x00 [8]), and the instruction byte must be written from least significant bit to most significant bit (right to left in the table located in the Instruction Byte Details section).

Note that even in LSB-first mode, the two respective phases of the communication cycle, the instruction byte phase and the data communication phase, retain their respective positions.

When in LSB-first mode, the device reads the instruction byte first (LSB to MSB), then calculates the expected number of bytes from the address provided, and then receives/provides data from the referenced register in LSB-first format (LSB to MSB of the register selected).

### Example Operation

In this example, the amplitude scale factor is calculated and written to present a 45° phase offset on the output of the AD9952. First, the default MSB-first case is considered. Then, the alternate LSB-first method is presented. For the purpose of the example, the following assumptions are made:

- The microcontroller is currently meeting the setup and hold times for the serial I/O port (this is a software only example).
- The phase offset change needs to occur at a known point in time (the data transfer needs to be synchronous).
- No other values are written or altered during the example.

### MSB-First Mode (Default) Case

First, the phase offset word (POW) needs to be calculated. Per the formula in the Phase Offset Word (POW) section, the POW is calculated to be  $45/360 \times 2^{14}$  or 2048 (h'800).

Next, the instruction byte to write to the POW needs to be sent. The first bit is 0, to indicate a write. The next two bits are don't care bits, and are set to 0. The last 5 bits correspond to the POW address, which is h'05. This makes the instruction byte: b'00001001.

Next, the data calculated in Step 1 is sent to the part. The POW is 2 bytes wide. To make the 14-bit value fit into the 16-bit register, the 2 MSBs are padded with don't care bits. In this example, the don't care bits are assumed to be 0. The 2 data bytes therefore are b'00001000 00000000.

Once the 24 bits of data are sent to the part (8 bits of instruction byte and 16 bits of data), the phase offset word I/O buffer is changed, but the change has not been made in the phase offset word (POW) register. As no other data is being written in this example, the I/O update pulse, which is 1.5 SYNC\_CLK cycles in duration, is sent to the I/O update pin. This transfers the data from the POW I/O buffer to the POW register.

### LSB First Mode Case

The values calculated in the MSB-first mode case are still valid. The order of the bits in the instruction byte and in the data bytes for the POW need to be reversed.

First, the instruction byte is sent. Because the part is now in LSB-first mode, the value sent is b'10010000.

Next, the data bytes are sent in LSB-first mode: b'00000000 00010000.

Finally, as before, the I/O update pin is pulsed with a high signal for duration of 1.5 SYNC\_CLK cycles, to transfer the contents of the POW I/O buffer to the POW register.

## POWER-DOWN FUNCTIONS

The AD9952 supports an externally controlled or hardware power-down feature as well as the more common software programmable power-down features found in other Analog Devices DDS products.

The software control power-down allows the DAC, comparator, PLL, input clock circuitry, and digital logic to be individually powered down via unique control bits (CFR1 [7:4]). With the exception of CFR1 [6], these bits are not active when the externally controlled power-down pin (PWRDWNCTL) is high. External power-down control is supported on the AD9952 via the PWRDWNCTL input pin.

When the PWRDWNCTL input pin is high, the AD9952 enters a power-down mode based on the CFR1 [3] bit. When the PWRDWNCTL input pin is low, the external power-down control is inactive.

When the CFR1 [3] bit is 0 and the PWRDWNCTL input pin is high, the AD9952 is put into a fast recovery power-down mode. In this mode, the digital logic and the DAC digital logic are powered down. The DAC bias circuitry, comparator, PLL, oscillator, and clock input circuitry is not powered down. The comparator can be individually powered down by setting the comparator power-down bit, CFR1 [6] = 1.

When the CFR1 [3] bit is high, and the PWRDWNCTL input pin is high, the AD9952 is put into the full power-down mode. In this mode, all functions are powered down. This includes the DAC and PLL, which take a significant amount of time to power up.

When the PWRDWNCTL input pin is high, the individual power-down bits (CFR1 [7] and CFR1 [5:4]) are invalid (don't care) and unused. When the PWRDWNCTL input pin is low, the individual power-down bits control the power-down modes of operation.

Note that the power-down signals are all designed such that a Logic 1 indicates the low power mode and a Logic 0 indicates the active or power-up mode.

Table 7 indicates the logic level for each power-down bit that drives out of the AD9952 core logic to the analog section and the digital clock generation section of the chip for the external power-down operation.

# AD9952

Table 7. Power-Down Control Functions

Control	Mode Active	Description
PWRDWNCTL = 0 CFR1 [3] don't care	Software control	Digital power-down = CFR1 [7] Comparator power-down = CFR1 [6] DAC power-down = CFR1 [5] Input clock power-down = CFR1 [4]
PWRDWNCTL = 1 CFR1 [3] = 0	External control, fast recovery power-down mode	Digital power-down = 1'b1 Comparator power-down = 1'b0 or CFR1 [6] DAC power-down = 1'b0 Input clock power-down = 1'b0
PWRDWNCTL = 1 CFR1 [3] = 1	External control, full power-down mode	Digital power-down = 1'b1 Comparator power-down = 1'b1 DAC power-down = 1'b1 Input clock power-down = 1'b1



## LAYOUT CONSIDERATIONS

For the best performance, the following layout guidelines should be observed. Always provide the analog power supply (AVDD) and the digital power supply (DVDD) on separate supplies, even if just from two different voltage regulators driven by a common supply. Likewise, the ground connections (AGND, DGND) should be kept separate as far back to the source as possible (for example, separate the ground planes on a localized board, even if the grounds connect to a common point in the system). Bypass capacitors should be placed as close to the supply pin as possible. Usually, a multitiered bypassing scheme consisting of a small high frequency capacitor (100 pF) placed close to the supply pin and progressively larger capacitors (0.1  $\mu$ F, 10  $\mu$ F) placed further away from the actual supply source works best.

## SUGGESTED APPLICATION CIRCUITS

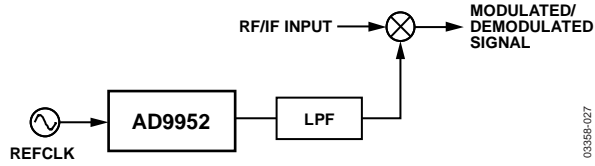

Figure 29. Synchronized LO for Upconversion/Down Conversion

03358-027

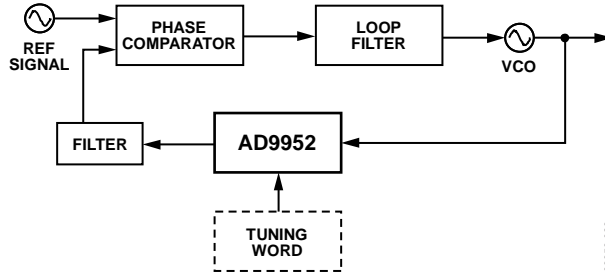

Figure 30. Digitally Programmable Divide-by-N Function in PLL

03358-028

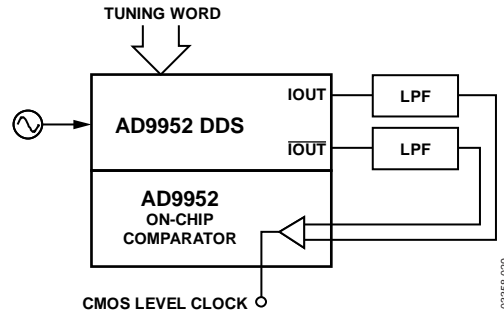

Figure 31. Frequency Agile Clock Generator

03358-029

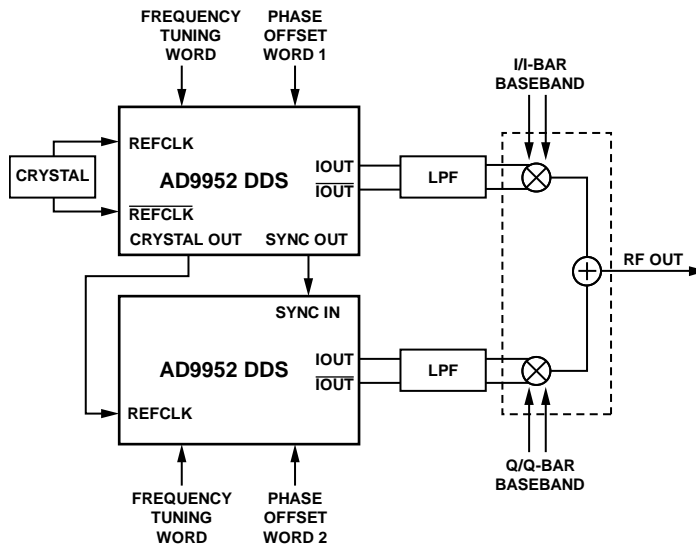
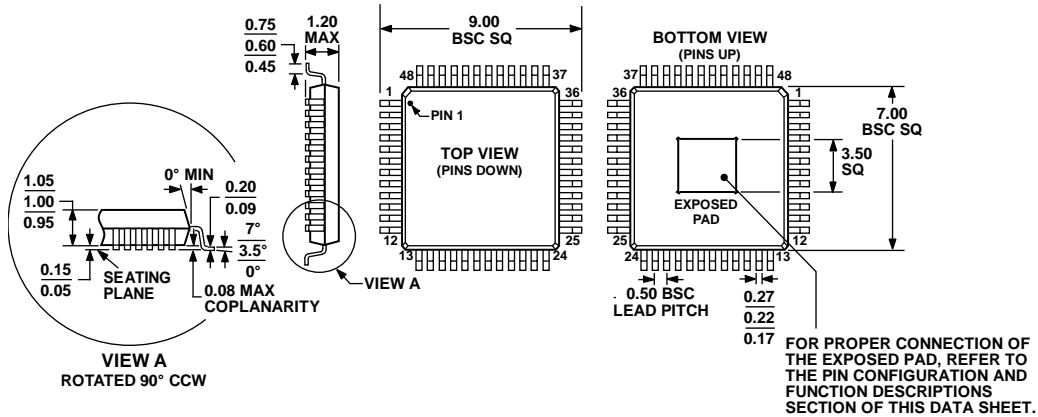

Figure 32. Two AD9952s Synchronized to Provide I Carriers and Q Carriers with Independent Phase Offsets for Nulling

03358-030

# OUTLINE DIMENSIONS



COMPLIANT TO JEDEC STANDARDS MS-026-ABC

Figure 33. 48-Lead Thin Quad Flat Package, Exposed Pad [TQFP\_EP] (SV-48-4)

Dimensions shown in millimeters

011708-A

## ORDERING GUIDE

Model	Temperature Range	Package Description	Ordering Quantity	Package Option
AD9952YSV	-40°C to +105°C	48-Lead Thin Quad Flat Package, Exposed Pad [TQFP_EP]		SV-48-4
AD9952YSV-REEL7	-40°C to +105°C	48-Lead Thin Quad Flat Package, Exposed Pad [TQFP_EP]	500	SV-48-4
AD9952YSVZ <sup>1</sup>	-40°C to +105°C	48-Lead Thin Quad Flat Package, Exposed Pad [TQFP_EP]		SV-48-4
AD9952YSVZ-REEL7 <sup>1</sup>	-40°C to +105°C	48-Lead Thin Quad Flat Package, Exposed Pad [TQFP_EP]	500	SV-48-4
AD9954/PCBZ <sup>1</sup>		Evaluation Board Used for the AD9952		

<sup>1</sup> Z = RoHS Compliant Part.

**AD9952**

**NOTES**

# Mouser Electronics

Authorized Distributor

Click to View Pricing, Inventory, Delivery & Lifecycle Information:

[Analog Devices Inc.:](#)

[AD9952YSVZ](#) [AD9952YSVZ-REEL7](#)