

FEATURES

- 400 mV \pm 0.275% threshold**
- Supply range: 1.7 V to 5.5 V**
- Low quiescent current: 6.5 μ A typical**
- Input range includes ground**
- Internal hysteresis: 9.3 mV typical**
- Low input bias current: \pm 5 nA maximum**
- Dual open-drain outputs**
- Small SOT-23 package**
- Qualified for automotive applications**

APPLICATIONS

- Li-Ion monitoring**
- Threshold detectors**
- Relay driving**
- Optoisolator driving**
- Industrial control systems**
- Handheld instruments**

GENERAL DESCRIPTION

The [ADCMP361](#) is a single low power, high accuracy comparator with a 400 mV reference in a 5-lead SOT-23 package. The internal 400 mV reference provides the ability to monitor low voltage supplies. The device operates on a supply voltage from 1.7 V to 5.5 V and only draws 6.5 μ A typical, making it suitable for low power system monitoring and portable applications. Hysteresis is included in the comparators.

There are dual open-drain outputs to enable the comparator and reference circuit to be used in an inverting or noninverting configuration. The outputs can be pulled to any voltage up to a maximum of 5.5 V. The output stage is guaranteed to sink greater than 5 mA over temperature

The device is suitable for portable, commercial, industrial, and automotive applications.

FUNCTIONAL BLOCK DIAGRAM

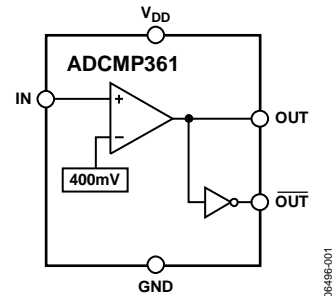

Figure 1.

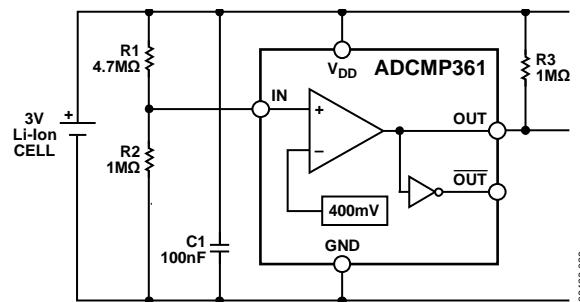

Figure 2. Typical Li-Ion Monitoring Application

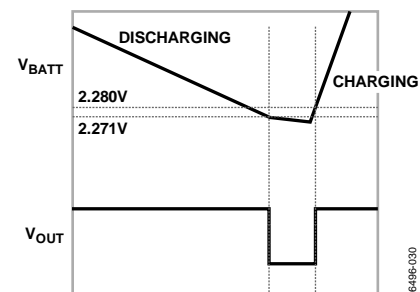

Figure 3. Li-Ion Monitoring Waveforms

Rev. B

[Document Feedback](#)

Information furnished by Analog Devices is believed to be accurate and reliable. However, no responsibility is assumed by Analog Devices for its use, nor for any infringements of patents or other rights of third parties that may result from its use. Specifications subject to change without notice. No license is granted by implication or otherwise under any patent or patent rights of Analog Devices. Trademarks and registered trademarks are the property of their respective owners.

TABLE OF CONTENTS

Features	1	Typical Performance Characteristics	6
Applications.....	1	Application Information.....	11
Functional Block Diagram	1	Comparators and Internal Reference	11
General Description	1	Power Supply.....	11
Revision History	2	Inputs	11
Specifications.....	3	Outputs	11
Absolute Maximum Ratings.....	4	Adding Hysteresis.....	11
Thermal Characteristics	4	Outline Dimensions	12
ESD Caution.....	4	Ordering Guide	12
Pin Configuration and Function Descriptions.....	5	Automotive Products.....	12

REVISION HISTORY

5/14—Rev. A to Rev. B

Changes to Adding Hysteresis Section and Added Figure 32;
Renumbered Sequentially..... 11

3/11—Rev. 0 to Rev. A

Changes to Features Section..... 1
Changes to Adding Hysteresis Section

2/07—Revision 0: Initial Version

SPECIFICATIONS

$V_{DD} = 1.7\text{ V to }5.5\text{ V}$, $-40^{\circ}\text{C} \leq T_A \leq +125^{\circ}\text{C}$, unless otherwise noted.

Table 1.

Parameter	Min	Typ	Max	Unit	Test Conditions/Comments
THRESHOLDS¹					
Rising Input Threshold Voltage	399.3	400.4	401.5	mV	$V_{DD} = 3.3\text{ V}$, $T_A = 25^{\circ}\text{C}$
	391.2	400.4	407.7	mV	$V_{DD} = 1.7\text{ V}$
	393.1	400.4	405.9	mV	$V_{DD} = 3.3\text{ V}$
	393.1	400.4	405.8	mV	$V_{DD} = 5.5\text{ V}$
Falling Input Threshold Voltage	381.1	391.1	400.9	mV	$V_{DD} = 1.7\text{ V}$
	381.2	391.1	398.4	mV	$V_{DD} = 3.3\text{ V}$
	381.0	391.1	398.2	mV	$V_{DD} = 5.5\text{ V}$
Hysteresis = $V_{TH(R)} - V_{TH(F)}$	2	9.3	13.5	mV	
Threshold Voltage Accuracy			± 0.275	%	$T_A = 25^{\circ}\text{C}$, $V_{DD} = 3.3\text{ V}$
Threshold Voltage Temperature Coefficient		16		ppm/ $^{\circ}\text{C}$	
POWER SUPPLY					
Supply Current		6.5	9	μA	$V_{DD} = 1.7\text{ V}$
		7.0	10	μA	$V_{DD} = 5.5\text{ V}$
INPUT CHARACTERISTICS					
Input Bias Current		0.01	5	nA	$V_{DD} = 1.7\text{ V}$, $V_{IN} = V_{DD}$
		0.01	5	nA	$V_{DD} = 1.7\text{ V}$, $V_{IN} = 0.1\text{ V}$
OPEN-DRAIN OUTPUTS					
Output Low Voltage ²		140	220	mV	$V_{DD} = 1.7\text{ V}$, $I_{OUT} = 3\text{ mA}$
		140	220	mV	$V_{DD} = 5.5\text{ V}$, $I_{OUT} = 5\text{ mA}$
Output Leakage Current ³		0.01	1	μA	$V_{DD} = 1.7\text{ V}$, $V_{OUT} = V_{DD}$
		0.01	1	μA	$V_{DD} = 1.7\text{ V}$, $V_{OUT} = 5.5\text{ V}$
DYNAMIC PERFORMANCE					
High-to-Low Propagation Delay ^{2,4}		10		μs	$V_{DD} = 5\text{ V}$, $V_{OL} = 400\text{ mV}$
Low-to-High Propagation Delay ^{2,4}		8		μs	$V_{DD} = 5\text{ V}$, $V_{OH} = 0.9 \times V_{DD}$
Output Rise time ^{2,4}		0.5		μs	$V_{DD} = 5\text{ V}$, $V_O = (0.1\text{ to }0.9) \times V_{DD}$
Output Fall time ^{2,4}		0.07		μs	$V_{DD} = 5\text{ V}$, $V_O = (0.1\text{ to }0.9) \times V_{DD}$

¹ $R_L = 100\text{ k}\Omega$, $V_O = 2\text{ V}$ swing.

² 10 mV input overdrive.

³ $V_{IN} = 40\text{ mV}$ overdrive.

⁴ $R_L = 10\text{ k}\Omega$.

ABSOLUTE MAXIMUM RATINGS

Table 2.

Parameter	Rating
V_{DD}	−0.3 V to +6 V
IN	−0.3 V to +6 V
OUT, $\overline{\text{OUT}}$	−0.3 V to +6 V
Operating Temperature Range	−40°C to +125°C
Storage Temperature Range	−65°C to +150°C
Lead Temperature	
Soldering (10 sec)	300°C
Vapor Phase (60 sec)	215°C
Infrared (15 sec)	220°C

Stresses above those listed under Absolute Maximum Ratings may cause permanent damage to the device. This is a stress rating only; functional operation of the device at these or any other conditions above those indicated in the operational section of this specification is not implied. Exposure to absolute maximum rating conditions for extended periods may affect device reliability.

THERMAL CHARACTERISTICS

θ_{JA} is specified for the worst-case conditions, that is, a device soldered in a circuit board for surface-mount packages.

Table 3. Thermal Resistance

Package Type	θ_{JA}	Unit
5-Lead SOT-23	240	°C/W

ESD CAUTION



ESD (electrostatic discharge) sensitive device. Charged devices and circuit boards can discharge without detection. Although this product features patented or proprietary protection circuitry, damage may occur on devices subjected to high energy ESD. Therefore, proper ESD precautions should be taken to avoid performance degradation or loss of functionality.

PIN CONFIGURATION AND FUNCTION DESCRIPTIONS

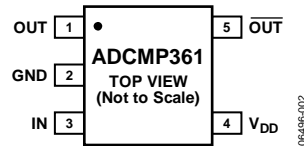

Figure 4. Pin Configuration

Table 4. Pin Function Descriptions

Pin No.	Mnemonic	Description
1	OUT	Noninverting Open-Drain Output.
2	GND	Ground.
3	IN	Monitors analog input voltage on comparator. The other input of the comparator is connected to a 400 mV reference.
4	V_{DD}	Power Supply.
5	$\overline{\text{OUT}}$	Inverting Open-Drain Output.

TYPICAL PERFORMANCE CHARACTERISTICS

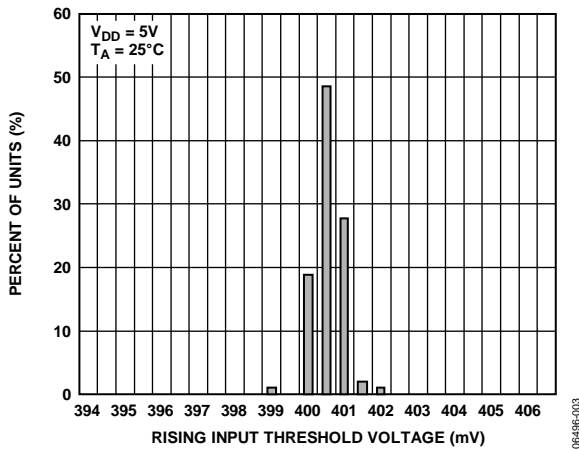

Figure 5. Distribution of Rising Input Threshold Voltage

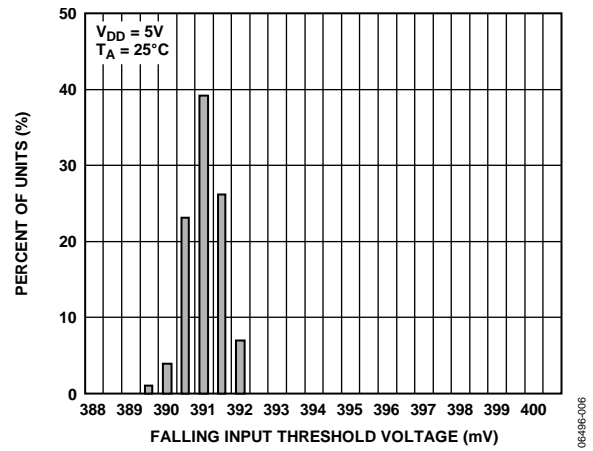

Figure 8. Distribution of Falling Input Threshold Voltage

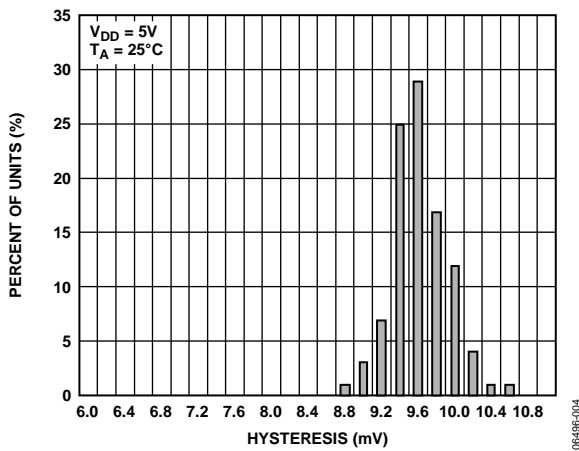

Figure 6. Distribution of Hysteresis

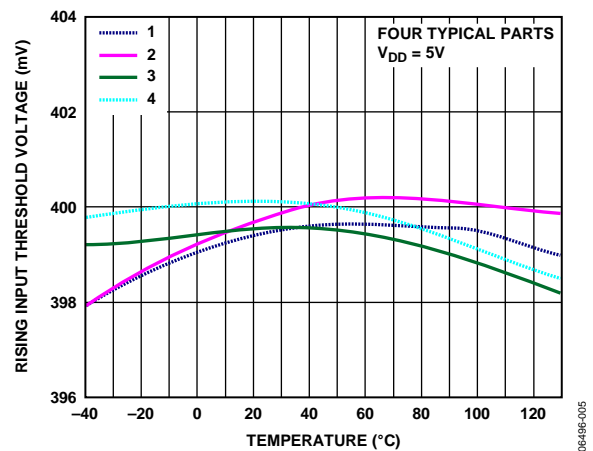

Figure 9. Rising Input Threshold Voltage vs. Temperature

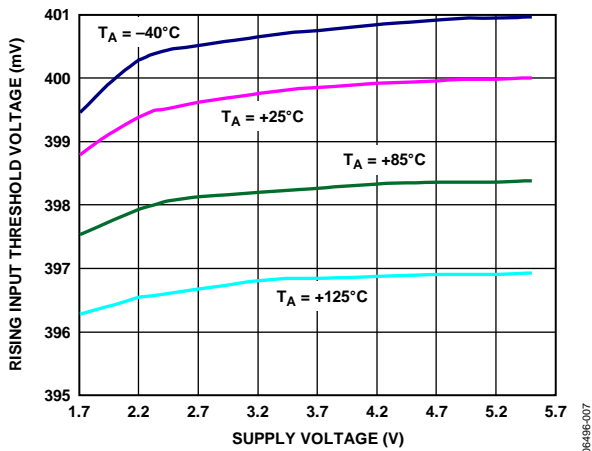

Figure 7. Rising Input Threshold Voltage vs. Supply Voltage

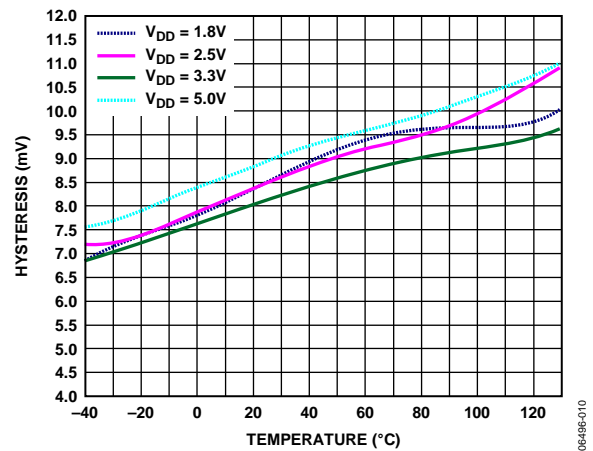

Figure 10. Hysteresis vs. Temperature

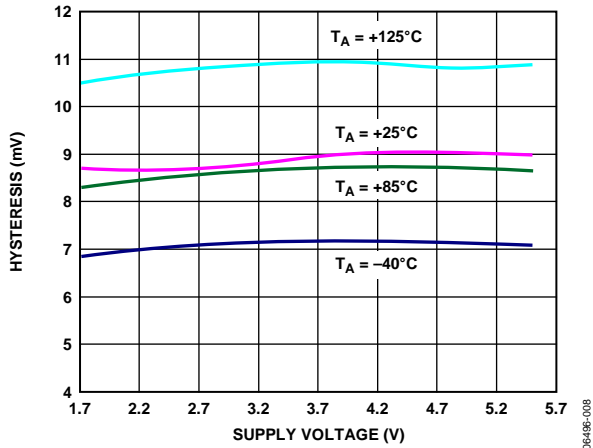

Figure 11. Hysteresis vs. Supply Voltage

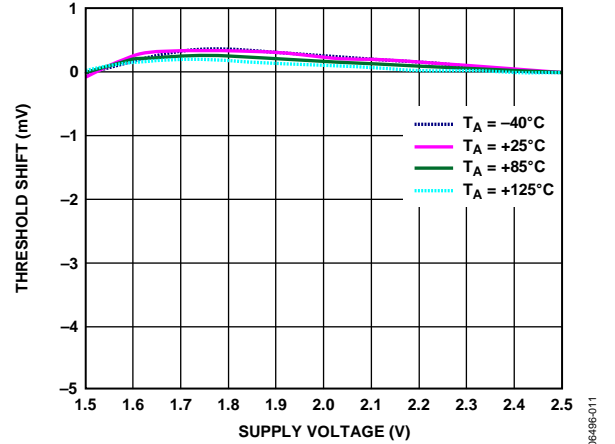

Figure 14. Minimum Supply Voltage

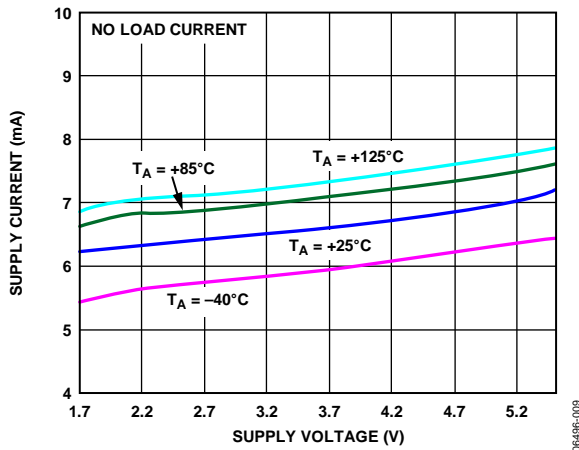

Figure 12. Quiescent Supply Current vs. Supply Voltage

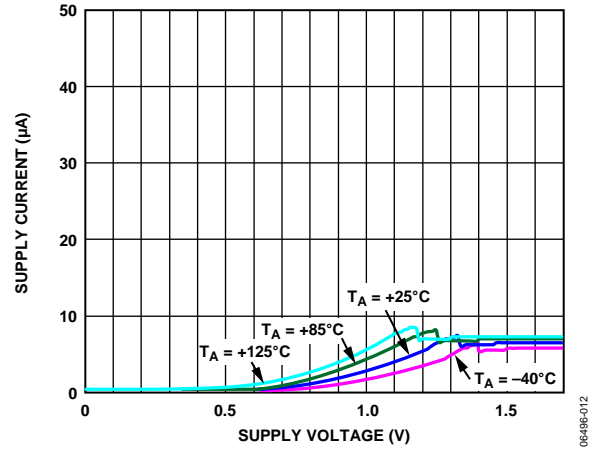

Figure 15. Start-Up Supply Current

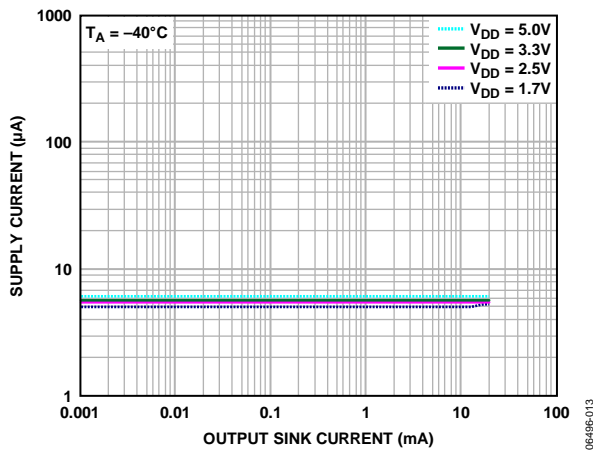

Figure 13. Supply Current vs. Output Sink Current

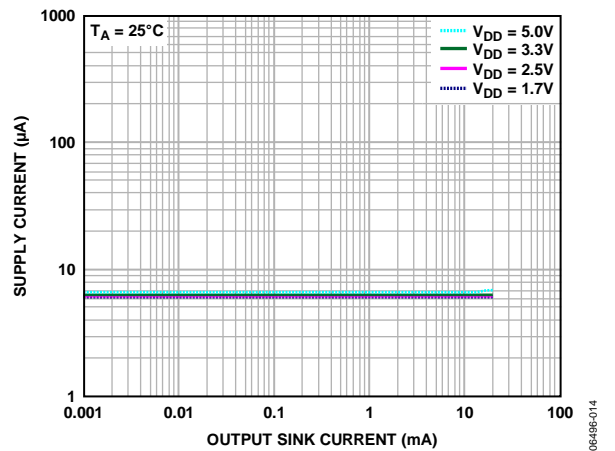

Figure 16. Supply Current vs. Output Sink Current

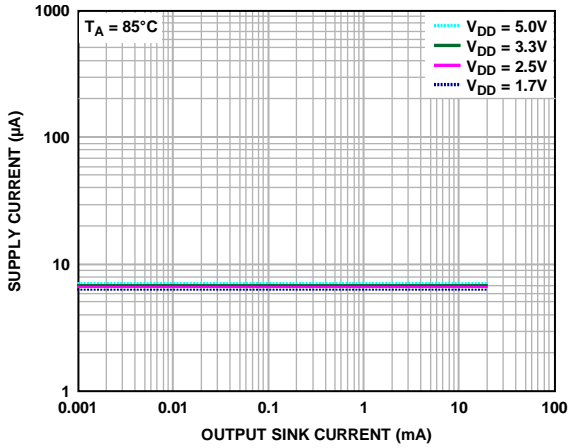

Figure 17. Supply Current vs. Output Sink Current

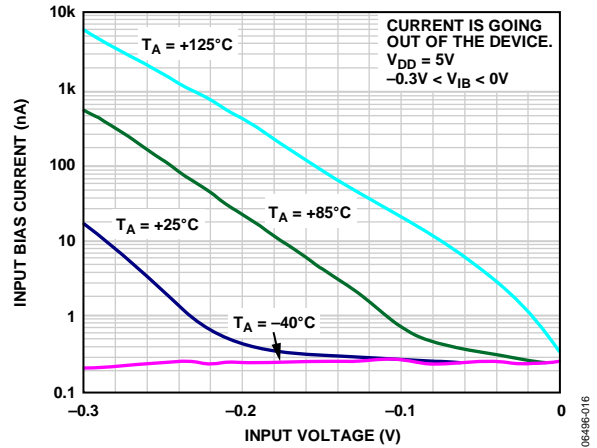

Figure 20. Below Ground Input Bias Current

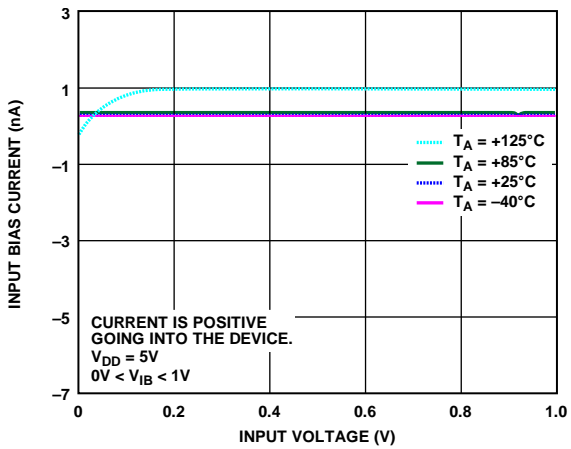

Figure 18. Low Level Input Bias Current

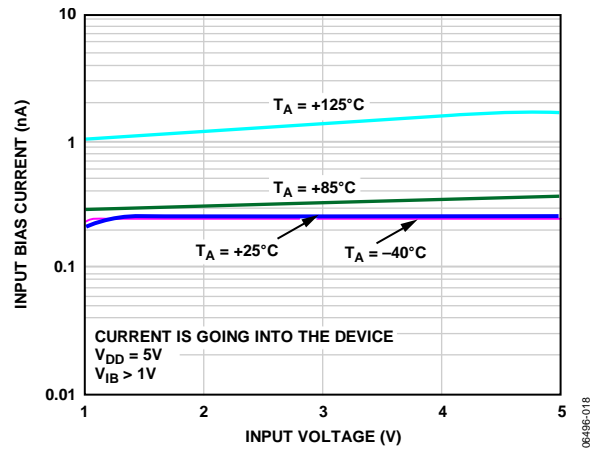

Figure 21. High Level Input Bias Current

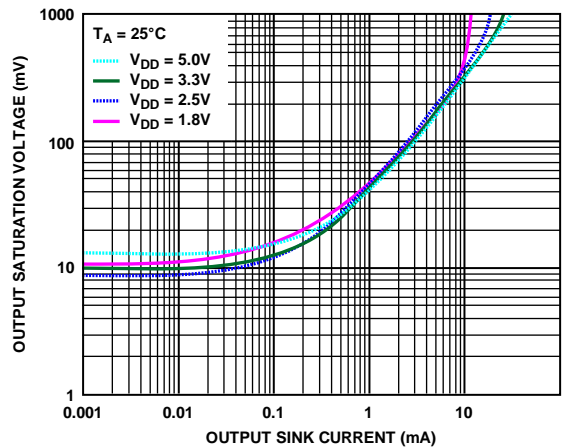

Figure 19. Output Saturation Voltage vs. Output Sink Current

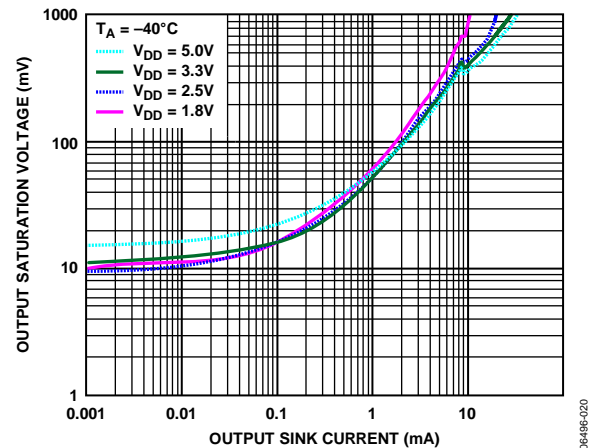

Figure 22. Output Saturation Voltage vs. Output Sink Current

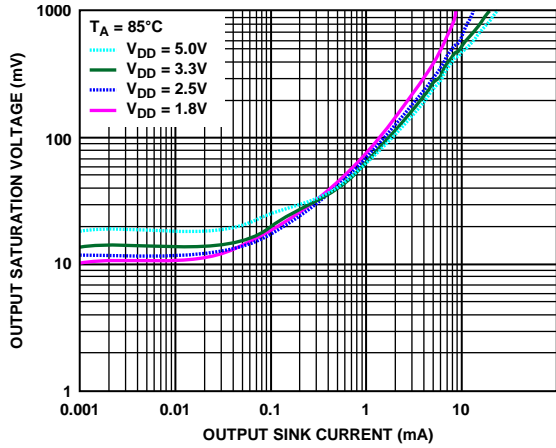

Figure 23. Output Saturation Voltage vs. Output Sink Current

06496-021

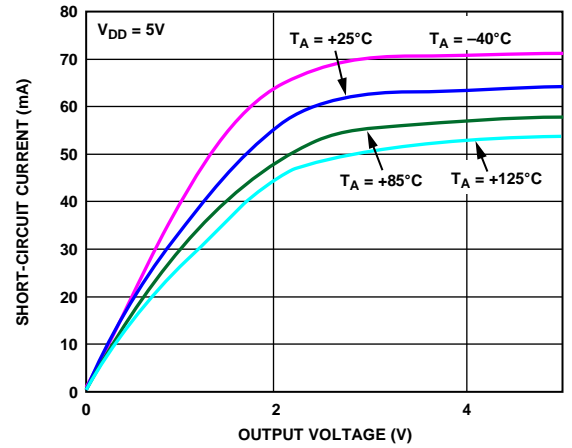

Figure 26. Short-Circuit Current vs. Output Voltage

06496-022

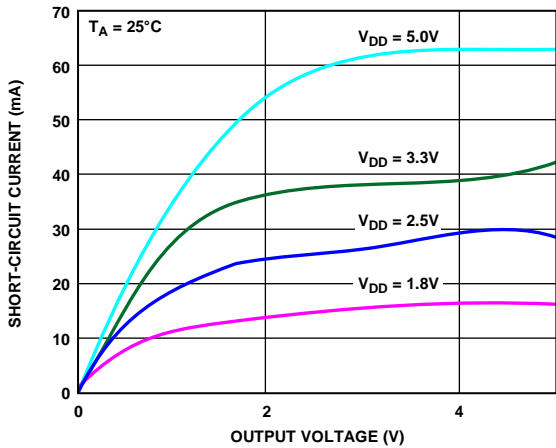

Figure 24. Short-Circuit Current vs. Output Voltage

06496-023

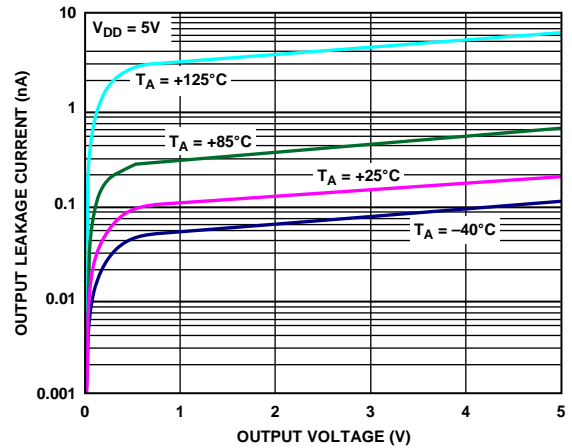

Figure 27. Output Leakage Current vs. Output Voltage

06496-024

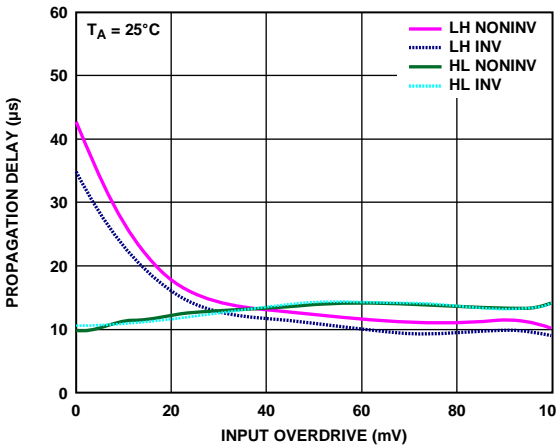

Figure 25. Propagation Delay vs. Input Overdrive

06496-025

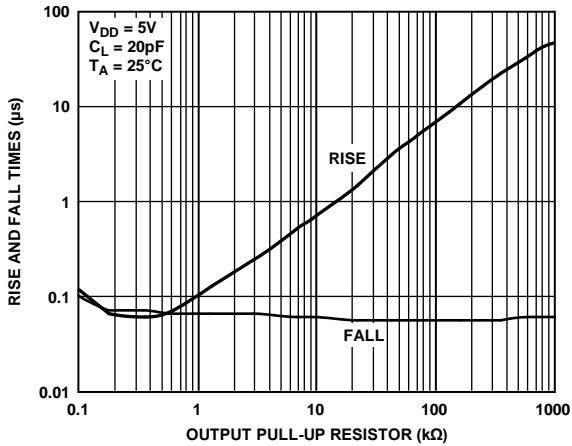

Figure 28. Rise and Fall Times vs. Output Pull-Up Resistor

06496-027

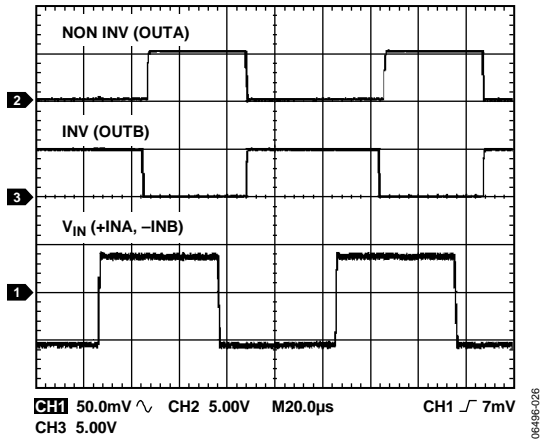

Figure 29. Noninverting and Inverting Comparators Propagation Delay

APPLICATION INFORMATION

The ADCMP361 is a low power comparator and reference circuit featuring a 400 mV reference that operates from 1.7 V to 5.5 V. The comparator is 0.275% accurate with a built-in hysteresis of 9.3 mV. There are two outputs, one the inverse of the other. This enables the ADCMP361 to be used as an inverting or a noninverting comparator circuit. These open-drain outputs are capable of sinking 40 mA.

COMPARATORS AND INTERNAL REFERENCE

The comparator has one input available externally; the other comparator input is connected internally to the 400 mV reference. The rising input threshold voltage of the comparators is designed to be equal to that of the reference.

POWER SUPPLY

The ADCMP361 is designed to operate from 1.7 V to 5.5 V. A 100 nF decoupling capacitor is recommended between V_{DD} and GND.

INPUTS

The comparator input is limited to the maximum V_{DD} voltage range. The voltage on these inputs can be above V_{DD} but never above the maximum allowed V_{DD} voltage. When adding a resistor string to the input, take care when choosing resistor values. This is due to the fact that the input bias current will be in parallel with the bottom resistor, R₂, of the input resistor divider string. This bottom resistor must therefore be chosen carefully in order to reduce the error introduced by this bias current (see Figure 30).

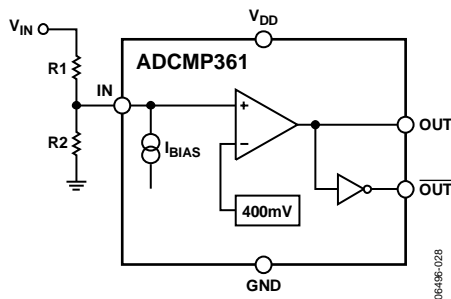

Figure 30. Input Bias Current Effect on Input Resistor String

OUTPUTS

The open-drain comparator outputs are limited to the maximum specified V_{DD} voltage range, regardless of the V_{DD} voltage. These outputs are capable of sinking up to 40 mA.

ADDING HYSTERESIS

To prevent oscillations at the output caused by noise or slowly moving signals passing the switching threshold, each comparator has built-in hysteresis of approximately 9.3 mV. Positive feedback can be used to increase hysteresis.

For the configuration shown in Figure 31, two resistors are used to create different switching thresholds, depending on whether the input signal is increasing or decreasing in magnitude. When

the input voltage is increasing, the threshold is above V_{REF}, and when it is decreasing, the threshold is below V_{REF}. V_{IN_HI} is the high input threshold used to trigger the output low to high transmission. V_{IN_LO} is the low input threshold used to trigger the output high to low transmission.

The upper input threshold level is given by

$$V_{IN_HI} = \frac{V_{REF}(R1 + R2)}{R2}$$

assuming R_{LOAD} >> R₂, R_{PULLUP} where V_{REF} = 0.4 V.

The lower input threshold level is given by

$$V_{IN_LO} = \frac{V_{REF}(R1 + R2 + R_{PULLUP}) - V_{CC}R1}{R2 + R_{PULLUP}}$$

The hysteresis is the difference between these voltage levels and is given by

$$\Delta V_{IN} = \frac{V_{CC}R1}{R2 + R_{PULLUP}}$$

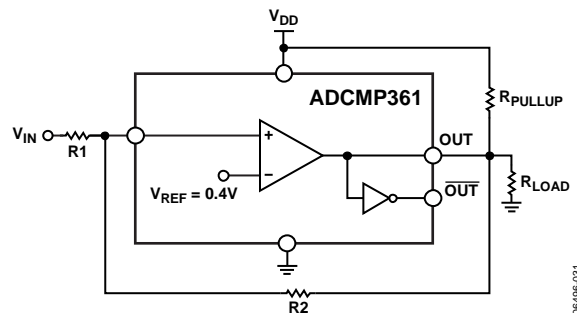

Figure 31. Comparator Configuration with Added Hysteresis

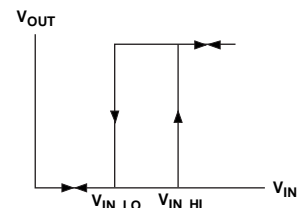
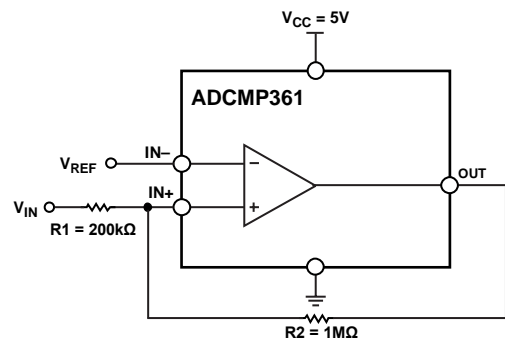
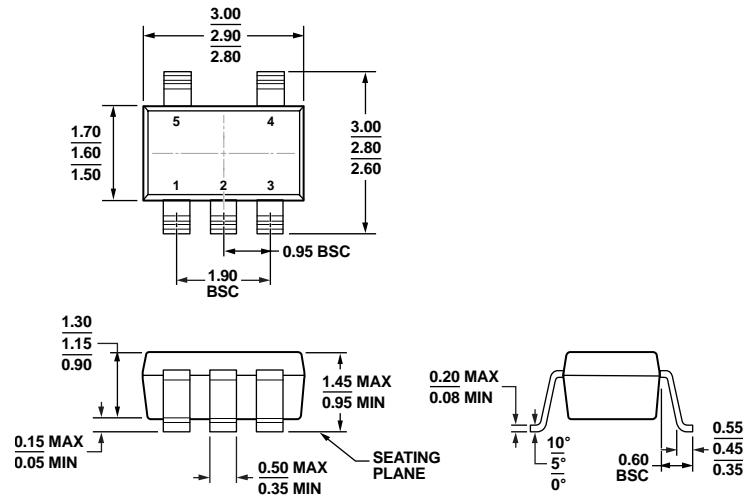

Figure 32. Noninverting Comparator Configuration with Hysteresis

OUTLINE DIMENSIONS



COMPLIANT TO JEDEC STANDARDS MO-178-AA

Figure 33. 5-Lead Small Outline Transistor Package [SOT-23] (RJ-5)

Dimensions shown in millimeters

11-01-2010-A

ORDERING GUIDE

Model ^{1, 2}	Temperature Range	Package Description	Package Option	Branding
ADCMP361YRJZ-REEL7	-40°C to +125°C	5-Lead SOT-23	RJ-5	M99
ADCMP361WRJZ-RL7	-40°C to +125°C	5-Lead SOT-23	RJ-5	M99

¹ Z = RoHS Compliant Part.

² W = Qualified for Automotive Applications.

AUTOMOTIVE PRODUCTS

The ADCMP361W models are available with controlled manufacturing to support the quality and reliability requirements of automotive applications. Note that these automotive models may have specifications that differ from the commercial models; therefore, designers should review the Specifications section of this data sheet carefully. Only the automotive grade products shown are available for use in automotive applications. Contact your local Analog Devices account representative for specific product ordering information and to obtain the specific Automotive Reliability reports for these models.

Mouser Electronics

Authorized Distributor

Click to View Pricing, Inventory, Delivery & Lifecycle Information:

[Analog Devices Inc.:](#)

[ADCMP361YRJZ-REEL7](#) [ADCMP361WYRJZ-RL7](#)