

# Analog Devices Welcomes Hittite Microwave Corporation

NO CONTENT ON THE ATTACHED DOCUMENT HAS CHANGED



**THIS PAGE INTENTIONALLY LEFT BLANK**



## SMT GaAs HBT MMIC x4 ACTIVE FREQUENCY MULTIPLIER, 14.4 - 16.4 GHz OUTPUT

### Typical Applications

The HMC370LP4(E) is ideal for:

- Point-to-Point & VSAT Radios
- Fiber Optic
- Military

### Features

- Output Power: 0 dBm
- Sub-Harmonic Suppression: >22 dBc
- SSB Phase Noise: -140 dBc/Hz
- Single Supply: +5V @ 55 mA
- 24 Lead 4x4 mm SMT Package: 16 mm<sup>2</sup>

### Functional Diagram

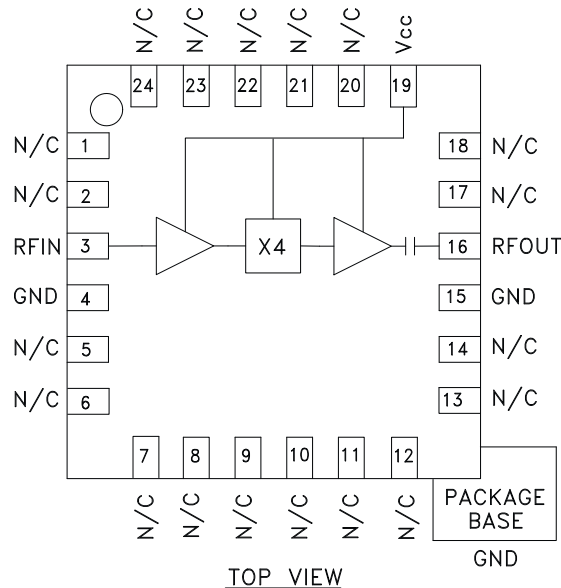

### General Description

The HMC370LP4(E) is an active miniature x4 frequency multiplier utilizing InGaP GaAs HBT technology in a 4x4 mm leadless surface mount package. Power output is 0 dBm typical from a 5V supply voltage and varies little vs. input power, temperature and supply voltage. Suppression of undesired fundamental and sub-harmonics is >22 dBc typical with respect to output signal level. The low additive SSB phase noise of -140 dBc/Hz at 100 kHz offset helps the user maintain good system noise performance. The HMC370LP4(E) are ideal for use in LO multiplier chains allowing reduced parts count vs. traditional approaches.

### Electrical Specifications, $T_A = +25^\circ\text{C}$ , $V_{CC} = 5\text{V}$

Parameter	Min.	Typ.	Max.	Units
Frequency Range, Input	3.6 - 4.1			GHz
Frequency Range, Output	14.4 - 16.4			GHz
Input Power Range	-15		+5	dBm
Output Power	-4	0		dBm
Sub-Harmonic Suppression		22		dBc
Input Return Loss		18		dB
Output Return Loss		7		dB
SSB Phase Noise (100 kHz Offset)	Pin = 0 dBm	-140		dBc/Hz
Supply Current (I <sub>cc</sub> )		55	73	mA

## SMT GaAs HBT MMIC x4 ACTIVE FREQUENCY MULTIPLIER, 14.4 - 16.4 GHz OUTPUT

**Output Power vs. Temperature @ -10 dBm Drive Level**

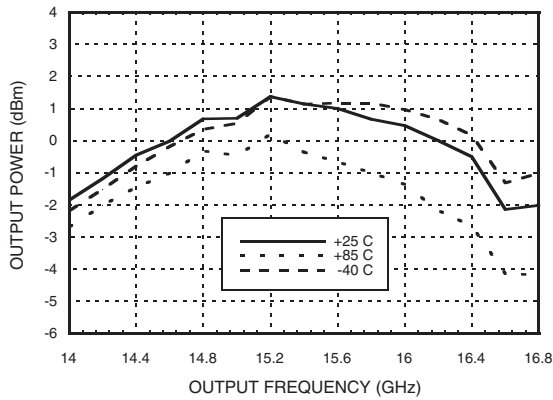

**Output Power vs. Drive Level**

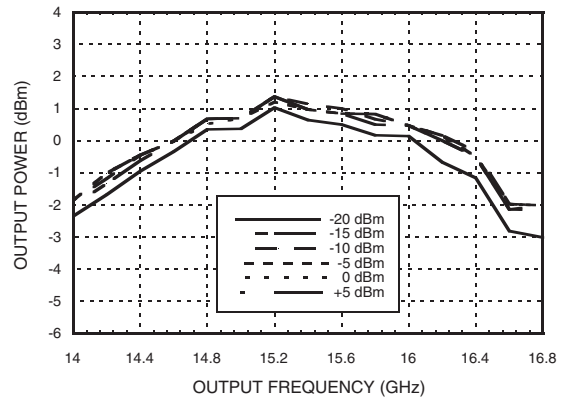

**Output Power vs. Supply Voltage @ -10 dBm Drive Level**

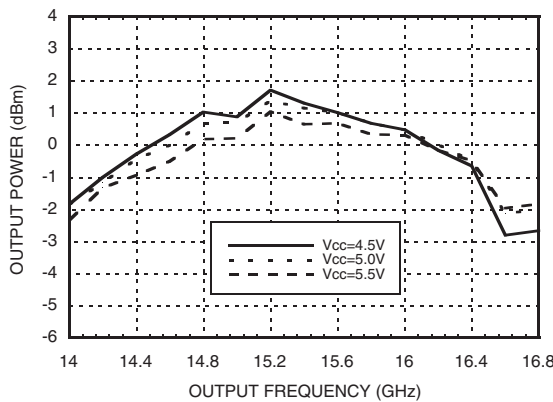

**Input Return Loss vs. Temperature**

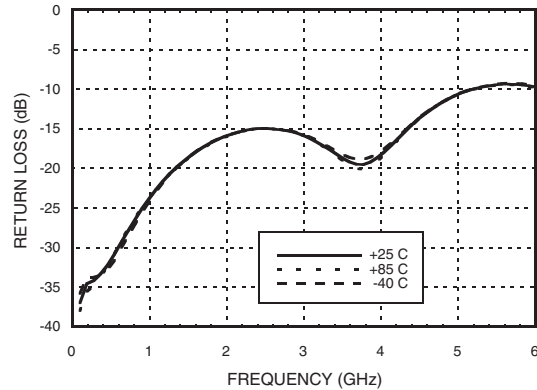

**Output Return Loss vs. Temperature**

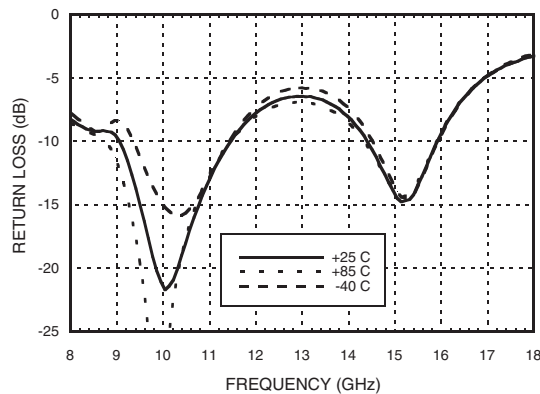



**SMT GaAs HBT MMIC x4 ACTIVE  
FREQUENCY MULTIPLIER, 14.4 - 16.4 GHz OUTPUT**

**Output Spectrum**

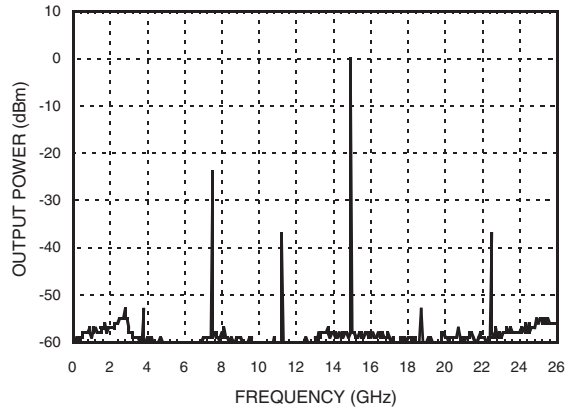

**SSB Phase Noise  
Performance,  $F_{out} = 15.0$  GHz**

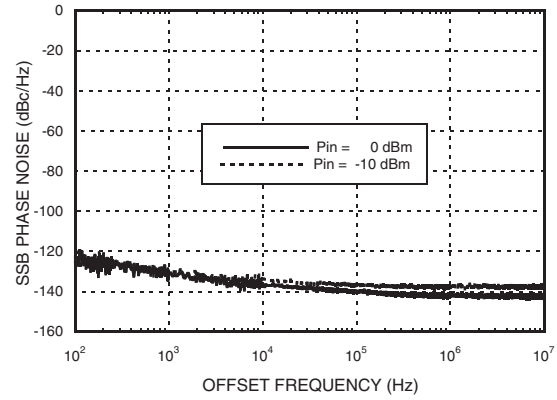

## SMT GaAs HBT MMIC x4 ACTIVE FREQUENCY MULTIPLIER, 14.4 - 16.4 GHz OUTPUT

### Absolute Maximum Ratings

RF Input (Vcc = +5V)	+20 dBm
Vcc	+5.5V
Channel Temperature	135 °C
Continuous Pdiss (T=85 °C) (derate 8.1 mW/°C above 85 °C)	530 mW
Thermal Resistance (R <sub>th</sub> ) (junction to ground paddle)	123.6 °C/W
Storage Temperature	-65 to +150 °C
Operating Temperature	-40 to +85 °C

### Typical Supply Current vs. Vcc

Vcc (V)	Icc (mA)
4.5	54
5.0	55
5.5	57

Note: Multiplier will operate over full voltage range shown above.



ELECTROSTATIC SENSITIVE DEVICE  
OBSERVE HANDLING PRECAUTIONS

### Outline Drawing

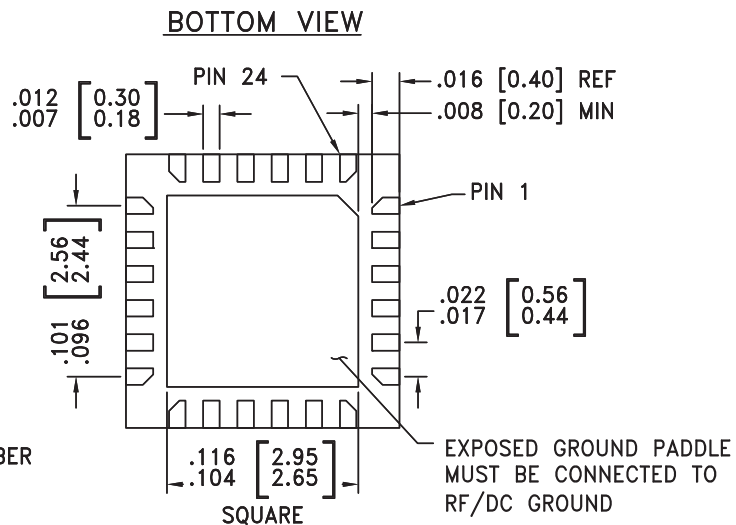
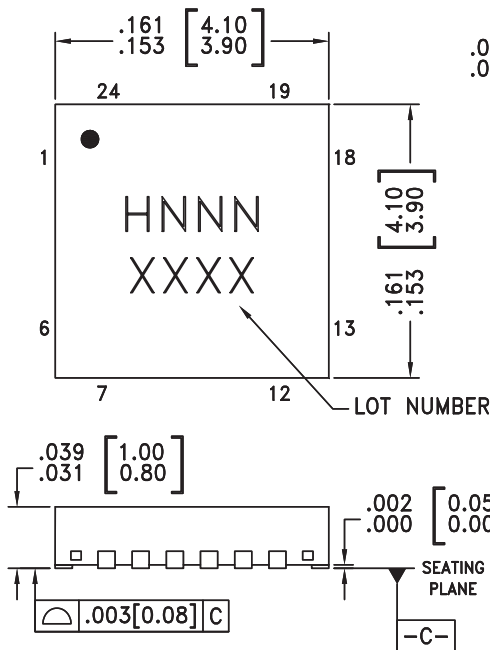

#### NOTES:

- LEADFRAME MATERIAL: COPPER ALLOY
- DIMENSIONS ARE IN INCHES [MILLIMETERS]
- LEAD SPACING TOLERANCE IS NON-CUMULATIVE.
- PAD BURR LENGTH SHALL BE 0.15mm MAXIMUM.  
PAD BURR HEIGHT SHALL BE 0.05mm MAXIMUM.
- PACKAGE WARP SHALL NOT EXCEED 0.05mm.
- ALL GROUND LEADS AND GROUND PADDLE MUST BE SOLDERED TO PCB RF GROUND.
- REFER TO HITTITE APPLICATION NOTE FOR SUGGESTED LAND PATTERN.

### Package Information

Part Number	Package Body Material	Lead Finish	MSL Rating	Package Marking <sup>[3]</sup>
HMC370LP4	Low Stress Injection Molding Plastic	Sn/Pb Solder	MSL1 <sup>[1]</sup>	H370 XXXX
HMC370LP4E	RoHS-compliant Low Stress Injection Molding Plastic	100% matte Sn	MSL1 <sup>[2]</sup>	H370 XXXX

[1] Max peak reflow temperature of 235 °C



[2] Max peak reflow temperature of 260 °C

[3] 4-Digit lot number XXXX

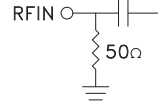

**SMT GaAs HBT MMIC x4 ACTIVE  
FREQUENCY MULTIPLIER, 14.4 - 16.4 GHz OUTPUT**

**Pin Description**

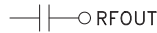
Pin Number	Function	Description	Interface Schematic
1, 2, 5-14, 17, 18, 20-24	N/C	The pins are not connected internally; however, all data shown herein was measured with these pins connected to RF/DC ground externally.	
3	RFIN	RF input needs to be DC blocked only if there is an external DC voltage applied to RF IN.	
4, 15	GND	All ground leads and ground paddle must be soldered to PCB RF/DC ground.	
16	RFOUT	Multiplied Output. AC coupled. No external DC blocks necessary.	
19	Vcc	Supply voltage 5V ± 0.5V.	

**Evaluation PCB**

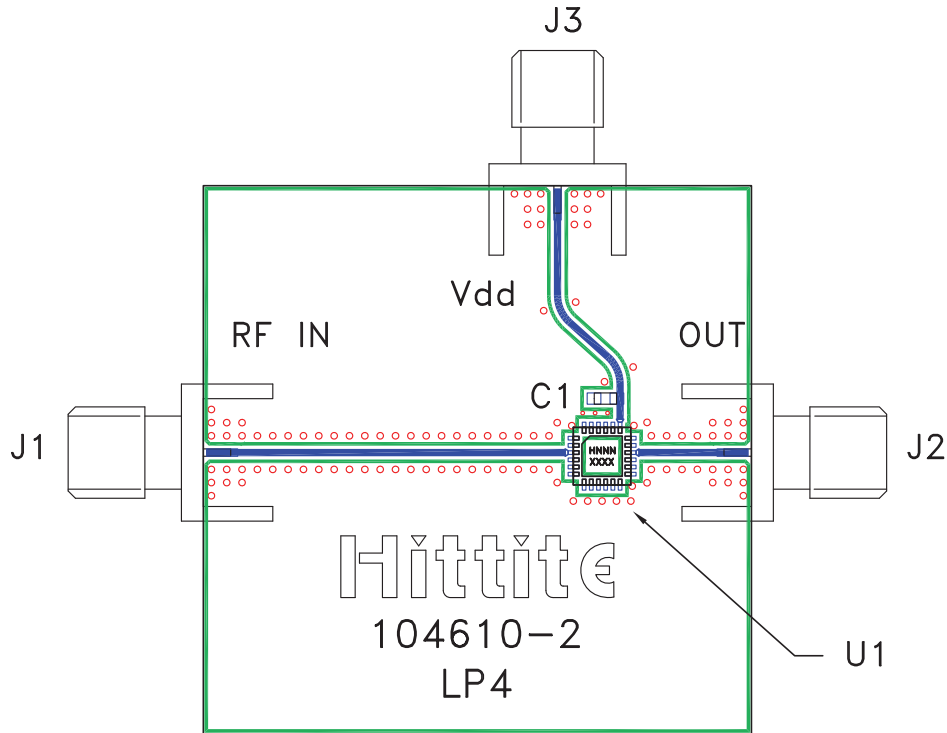

**List of Materials for Evaluation PCB 106137 [1]**

Item	Description
J1 - J3	PCB Mount SMA Connector
C1	1,000 pF Capacitor, 0603 Pkg.
U1	HMC370LP4(E) x4 Active Multiplier
PCB [2]	104610 Eval Board

[1] Reference this number when ordering complete evaluation PCB

[2] Circuit Board Material: Rogers 4350

The circuit board used in the application should be generated with proper RF circuit design techniques. Signal lines should have 50 Ohm impedance while the package ground leads and exposed paddle should be connected directly to the ground plane similar to that shown. The evaluation circuit board shown is available from Hittite upon request.



# Mouser Electronics

Authorized Distributor

Click to View Pricing, Inventory, Delivery & Lifecycle Information:

[Analog Devices Inc.:](#)

[HMC370LP4E](#) [106137-HMC370LP4](#) [HMC370LP4](#) [HMC370LP4ETR](#) [HMC370LP4TR](#)