

**1.4MHz, 1.5A ASYNCHRONOUS DC-DC BUCK CONVERTER AP3211**

## General Description

The AP3211 is a 1.4MHz fixed frequency, current mode, PWM buck (step-down) DC-DC converter, capable of driving a 1.5A load with high efficiency, excellent line and load regulation. The device integrates N-channel power MOSFET switch with low on-resistance. Current mode control provides fast transient response and cycle-by-cycle current limit.

A standard series of inductors are available from several different manufacturers optimized for use with the AP3211. This feature greatly simplifies the design of switch-mode power supplies.

The AP3211 is available in SOT-23-6 package.

## Features

- Input Voltage Range: 4.5V to 18V
- Output Voltage Adjustable from 0.81V to 15V
- Fixed 1.4MHz Frequency
- High Efficiency: up to 92%
- Output Current: 1.5A
- Current Mode Control
- Built-in Over Current Protection
- Built-in Thermal Shutdown Function
- Built-in UVLO Function
- Built-in Over Voltage Protection
- Built-in Soft-start

## Applications

- LCD TV
- DPF
- Portable DVD

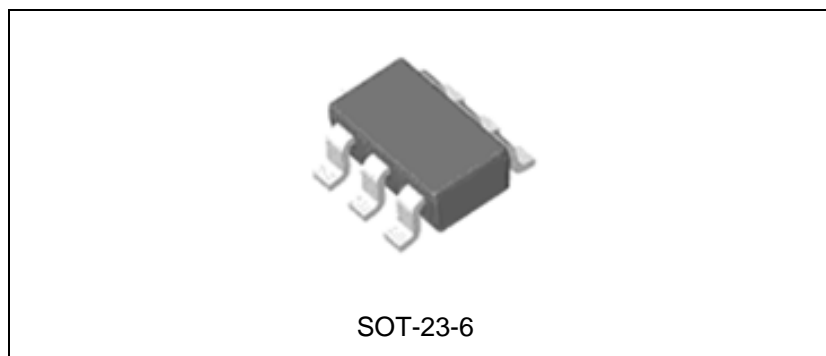

Figure 1. Package Type of AP3211

**1.4MHz, 1.5A ASYNCHRONOUS DC-DC BUCK CONVERTER AP3211**
**Pin Configuration**

Figure 2. Pin Configuration of AP3211 (Top View)

**Pin Description**

Pin Number	Pin Name	Function
1	BS	Bootstrap pin. A bootstrap capacitor is connected between the BS pin and SW pin. The voltage across the bootstrap capacitor drives the internal high-side NMOS switch
2	GND	Ground pin
3	FB	Feedback pin. This pin is connected to an external resistor divider to program the system output voltage. When $V_{FB}$ exceeds 20% of the nominal regulation value of 0.81V, the OVP is triggered. When $V_{FB} < 0.25V$ , the oscillator frequency is lowered to realize short circuit protection
4	EN	Control input pin. Forcing this pin above 1.5V enables the IC. Forcing this pin below 0.4V shuts down the IC. When the IC is in shutdown mode, all functions are disabled to decrease the supply current below 1 $\mu$ A
5	IN	Supply input pin. A capacitor should be connected between the IN pin and GND to keep the DC input voltage constant
6	SW	Power switch output pin. This pin is connected to the inductor and bootstrap capacitor

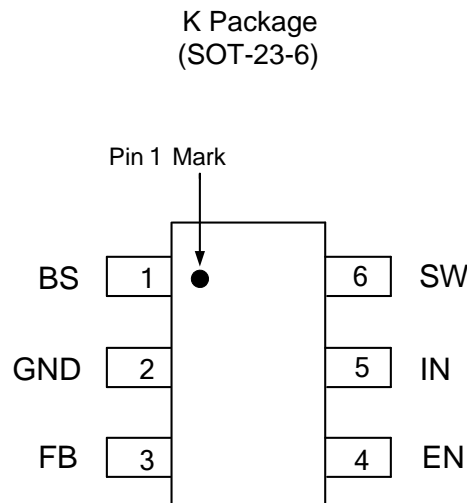

**1.4MHz, 1.5A ASYNCHRONOUS DC-DC BUCK CONVERTER AP3211****Absolute Maximum Ratings (Note 1)**

Parameter	Symbol	Value	Unit
Input Pin Voltage	$V_{IN}$	-0.3 to 20	V
EN Pin Voltage	$V_{EN}$	-0.3 to $V_{IN}+0.3$	V
SW Pin Voltage	$V_{SW}$	21	V
Bootstrap Pin Voltage	$V_{BS}$	-0.3 to $V_{SW}+6$	V
Feedback Pin Voltage	$V_{FB}$	-0.3 to 6V	V
Thermal Resistance	$\theta_{JA}$	220	°C/W
Operating Junction Temperature	$T_J$	150	°C
Storage Temperature	$T_{STG}$	-65 to 150	°C
Lead Temperature (Soldering, 10sec)	$T_{LEAD}$	260	°C
ESD (Human Body Model)		2000	V
ESD (Machine Model)		200	V

Note 1: Stresses greater than those listed under “Absolute Maximum Ratings” may cause permanent damage to the device. These are stress ratings only, and functional operation of the device at these or any other conditions beyond those indicated under “Recommended Operating Conditions” is not implied. Exposure to “Absolute Maximum Ratings” for extended periods may affect device reliability.

**Recommended Operating Conditions**

Parameter	Symbol	Min	Max	Unit
Input Voltage	$V_{IN}$	4.5	18	V
Maximum Output Current	$I_{OUT(MAX)}$	1.5		A
Operating Ambient Temperature	$T_A$	-40	85	°C

**1.4MHz, 1.5A ASYNCHRONOUS DC-DC BUCK CONVERTER AP3211****Electrical Characteristics**

$V_{IN}=V_{EN}=12V$ ,  $V_{OUT}=3.3V$ ,  $T_A=25^\circ C$ , unless otherwise specified.

Parameter	Symbol	Conditions	Min	Typ	Max	Unit
Input Voltage	$V_{IN}$		4.5		18	V
Quiescent Current	$I_Q$	$V_{FB}=0.9V$		0.8	1.1	mA
Shutdown Supply Current	$I_{SHDN}$	$V_{EN}=0V$		0.1	1.0	$\mu A$
Feedback Voltage	$V_{FB}$		0.785	0.810	0.835	V
Feedback Over Voltage Threshold	$V_{FBOV}$			0.972		V
Feedback Bias Current	$I_{FB}$	$V_{FB}=0.85V$	-0.1		0.1	$\mu A$
Switch On-resistance	$R_{DSON}$	$I_{SW}=1A$		0.35		$\Omega$
Switch Leakage Current	$I_{LEAK}$	$V_{IN}=18V$ , $V_{EN}=0V$		0.1	10	$\mu A$
Switch Current Limit	$I_{LIM}$		1.8	2.4		A
EN Pin Threshold	$V_{ENH}$		1.5			V
	$V_{ENL}$				0.4	
Input UVLO Threshold	$V_{UVLO}$	$V_{IN}$ Rising	3.3	3.8	4.3	V
Input UVLO Hysteresis	$V_{HYS}$			0.2		V
Oscillator Frequency	$f_{OSC1}$		1.1	1.4	1.7	MHz
	$f_{OSC2}$	Short Circuit		460		kHz
Max. Duty Cycle	$D_{MAX}$	$V_{FB}=0.6V$		90		%
Min. Duty Cycle	$D_{MIN}$	$V_{FB}=0.9V$			0	%
Minimum On Time	$t_{ON}$			100		ns
Thermal Shutdown	$T_{OTSD}$			160		$^\circ C$
Thermal Shutdown Hysteresis	$T_{HYS}$			20		$^\circ C$
Soft-start Time	$t_{SS}$			200		$\mu s$

Note 2:  $R_{DSON}$ ,  $t_{ON}$ ,  $T_{OTSD}$ ,  $T_{HYS}$  and  $t_{SS}$  are guaranteed by design.

**1.4MHz, 1.5A ASYNCHRONOUS DC-DC BUCK CONVERTER AP3211**

**Typical Performance Characteristics**

$T_A=25^\circ\text{C}$ ,  $V_{IN}=12\text{V}$ ,  $V_{EN}=5\text{V}$ ,  $V_{OUT}=3.3\text{V}$ , unless otherwise noted.

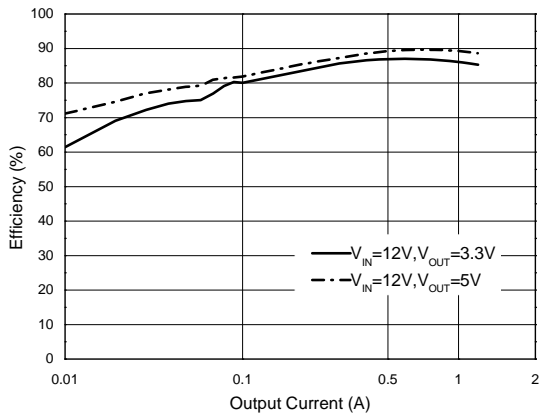

Figure 4. Efficiency vs. Output Current

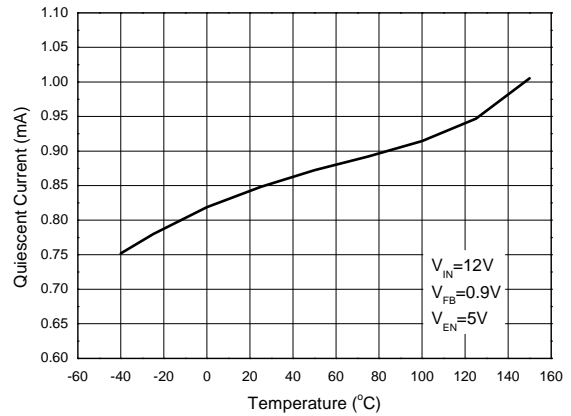

Figure 5. Quiescent Current vs. Temperature

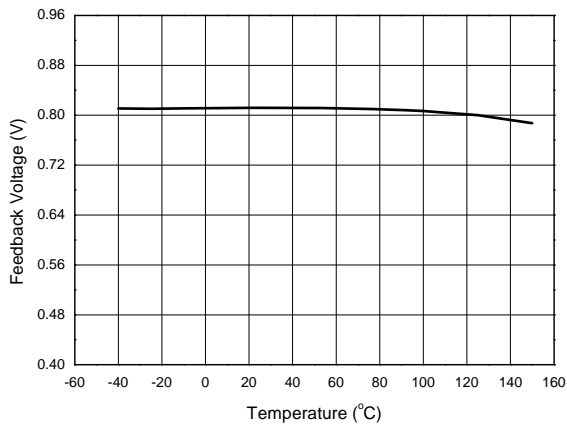

Figure 6. Feedback Voltage vs. Temperature

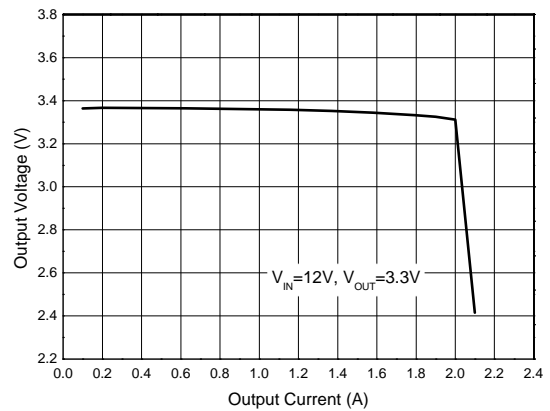

Figure 7. Output Voltage vs. Output Current

**1.4MHz, 1.5A ASYNCHRONOUS DC-DC BUCK CONVERTER AP3211**

**Typical Performance Characteristics (Continued)**

$T_A=25^{\circ}\text{C}$ ,  $V_{IN}=12\text{V}$ ,  $V_{EN}=5\text{V}$ ,  $V_{OUT}=3.3\text{V}$ , unless otherwise noted.

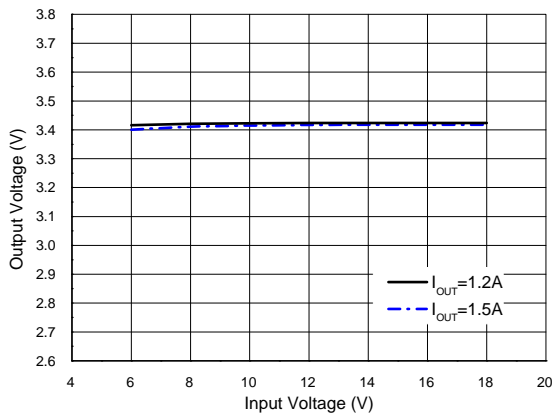

Figure 8. Output Voltage vs. Input Voltage

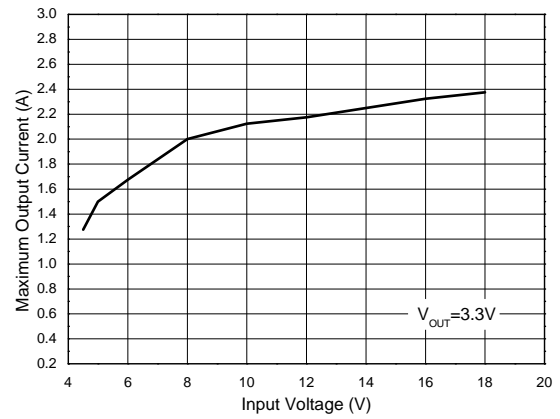

Figure 9. Maximum Output Current vs. Input Voltage

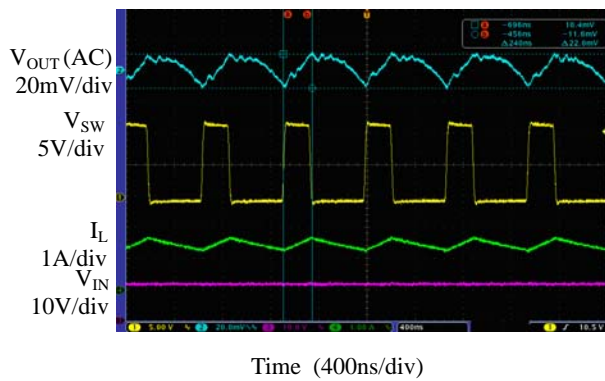

Figure 10. Output Ripple ( $I_{OUT}=1.5\text{A}$ )

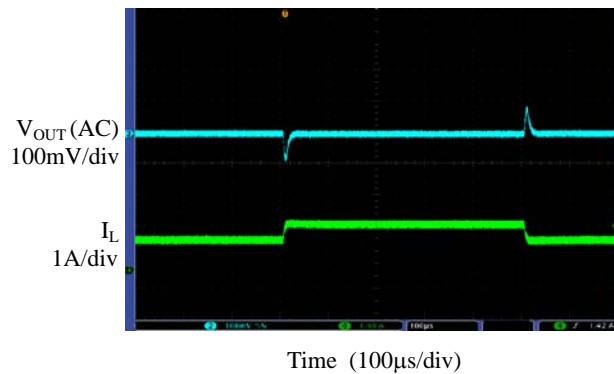

Figure 11. Load Transient ( $I_{OUT}=1$  to  $1.5\text{A}$ )

**1.4MHz, 1.5A ASYNCHRONOUS DC-DC BUCK CONVERTER AP3211**

**Typical Performance Characteristics (Continued)**

$T_A=25^{\circ}\text{C}$ ,  $V_{IN}=12\text{V}$ ,  $V_{EN}=5\text{V}$ ,  $V_{OUT}=3.3\text{V}$ , unless otherwise noted.

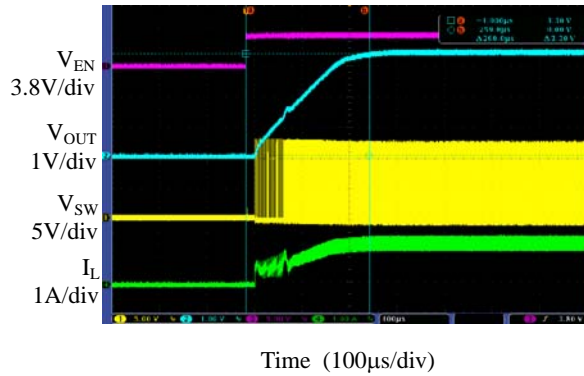

Figure 12. Enable Turn-on Characteristic  
(Resistance Load,  $R_{LOAD}=2.6\Omega$ )

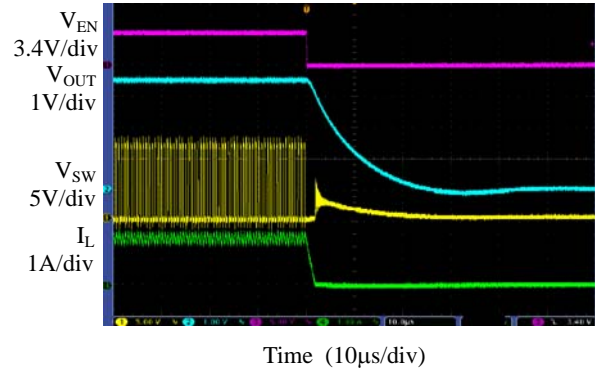

Figure 13. Enable Turn-off Characteristic  
(Resistance Load,  $R_{LOAD}=2.6\Omega$ )

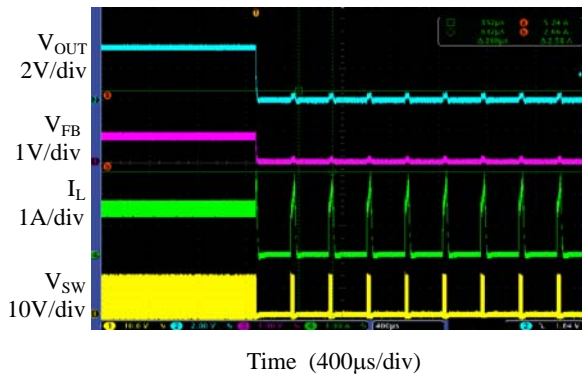

Figure 14. Short Circuit Protection ( $I_{OUT}=1.5\text{A}$ )

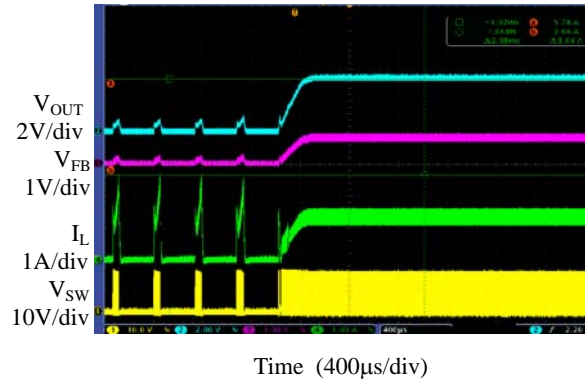

Figure 15. Short Circuit Recovery ( $R_{LOAD}=2.6\Omega$ )



**1.4MHz, 1.5A ASYNCHRONOUS DC-DC BUCK CONVERTER AP3211**

**Typical Performance Characteristics (Continued)**

$T_A=25^{\circ}\text{C}$ ,  $V_{IN}=12\text{V}$ ,  $V_{EN}=5\text{V}$ ,  $V_{OUT}=3.3\text{V}$ , unless otherwise noted.

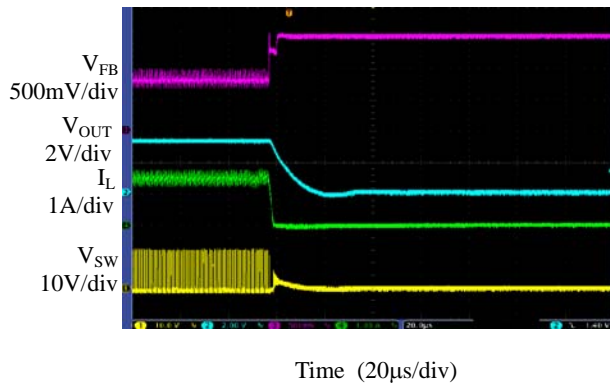

Figure 16. Over Voltage Protection ( $I_{OUT}=1.5\text{A}$ )

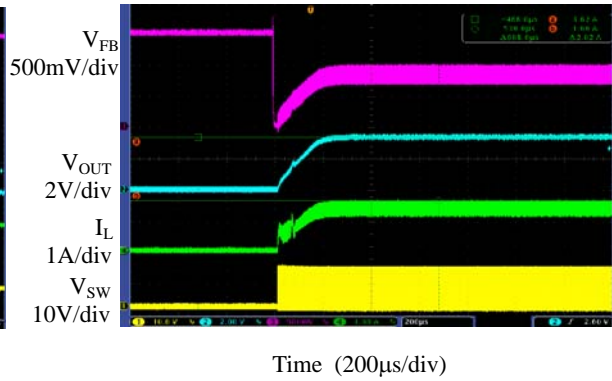

Figure 17. Over Voltage Recovery ( $I_{OUT}=1.5\text{A}$ )

**1.4MHz, 1.5A ASYNCHRONOUS DC-DC BUCK CONVERTER AP3211**
**Typical Application**

Figure 18. Typical Application Circuit of AP3211

**1.4MHz, 1.5A ASYNCHRONOUS DC-DC BUCK CONVERTER AP3211**

**Mechanical Dimensions**

**SOT-23-6**

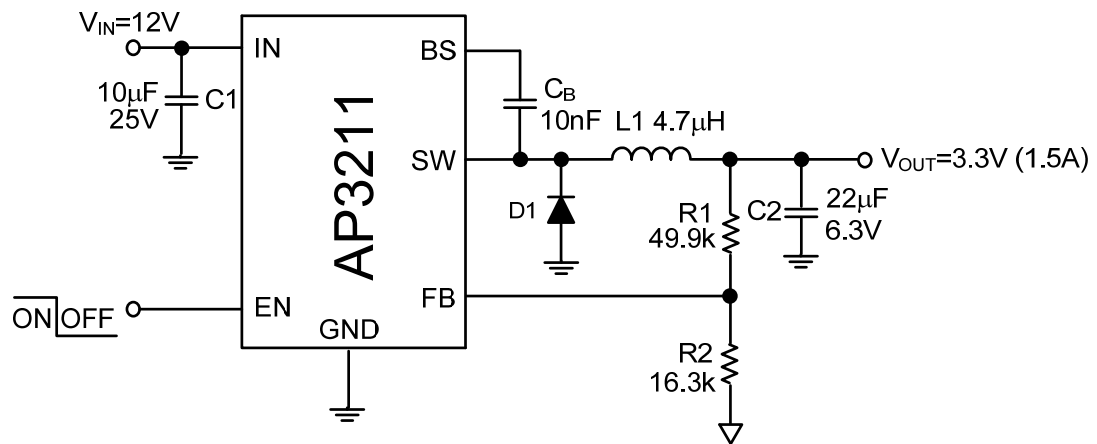
**Unit: mm(inch)**

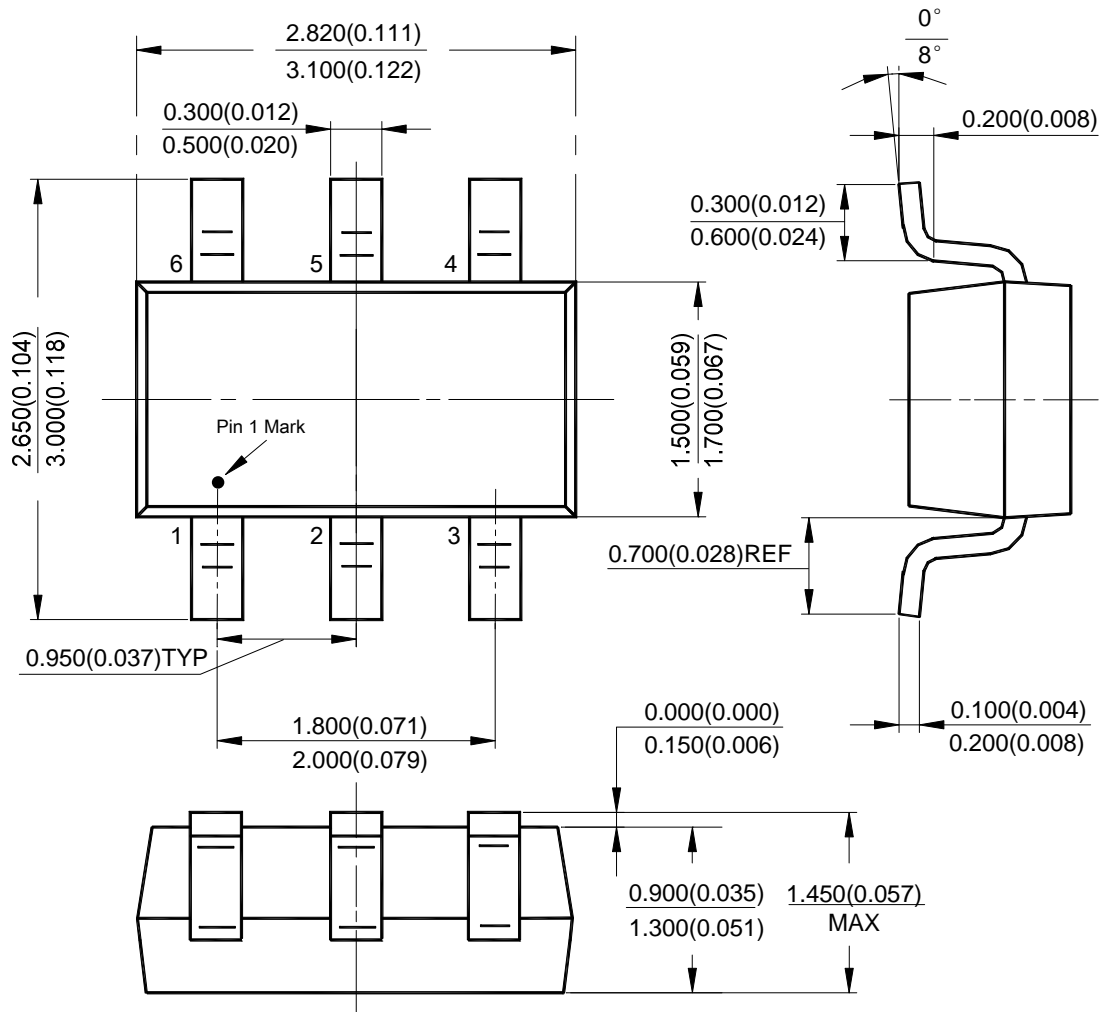

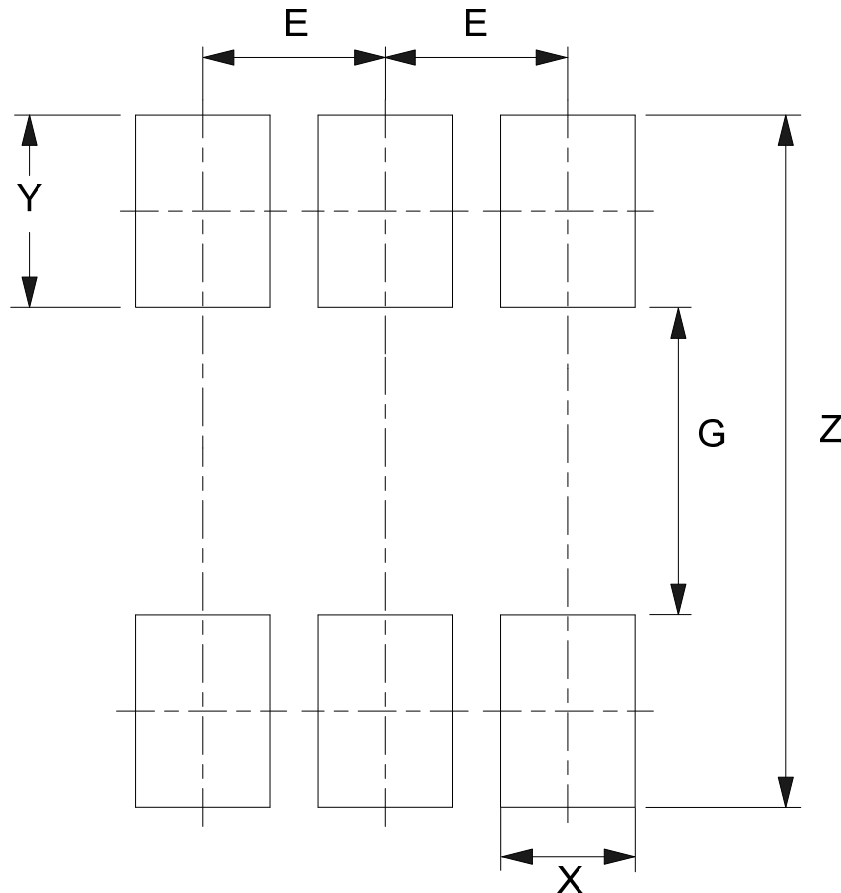
**Mounting Pad Layout**
**SOT-23-6**

Dimensions	Z (mm)/(inch)	G (mm)/(inch)	X (mm)/(inch)	Y (mm)/(inch)	E (mm)/(inch)
Value	3.600/0.142	1.600/0.063	0.700/0.028	1.000/0.039	0.950/0.037



## BCD Semiconductor Manufacturing Limited

<http://www.bcdsemi.com>

### IMPORTANT NOTICE

BCD Semiconductor Manufacturing Limited reserves the right to make changes without further notice to any products or specifications herein. BCD Semiconductor Manufacturing Limited does not assume any responsibility for use of any its products for any particular purpose, nor does BCD Semiconductor Manufacturing Limited assume any liability arising out of the application or use of any its products or circuits. BCD Semiconductor Manufacturing Limited does not convey any license under its patent rights or other rights nor the rights of others.

---

#### MAIN SITE

##### - Headquarters

##### BCD (Shanghai) Micro-electronics Limited

No. 1600, Zi Xing Road, Shanghai ZiZhu Science-based Industrial Park, 200241, P. R. C.  
Tel: +86-021-2416-2266, Fax: +86-021-2416-2277

##### - Wafer Fab

##### Shanghai SIM-BCD Semiconductor Manufacturing Co., Ltd.

800 Yishan Road, Shanghai 200233, China  
Tel: +021-6485-1491, Fax: +86-021-5450-0008

#### REGIONAL SALES OFFICE

##### Shenzhen Office

##### Shanghai SIM-BCD Semiconductor Manufacturing Co., Ltd., Shenzhen Office

Unit A Room 1203, Skyworth Bldg., Gaoxin Ave.1.S., Nanshan District  
Shenzhen 518057, China

Tel: +86-0755-8660-4900, Fax: +86-0755-8660-4958

##### Taiwan Office (Taipei)

##### BCD Semiconductor (Taiwan) Company Limited

3F, No.17, Lane 171, Sec. 2, Jiu-Zong Rd., Nei-Hu Dist., Taipei(114), Taiwan, R.O.C  
Tel: +886-2-2656-2808

Fax: +886-2-2656-2806/26562950

##### Taiwan Office (Hsinchu)

##### BCD Semiconductor (Taiwan) Company Limited

8F, No.176, Sec. 2, Gong-Dao 5th Road, East District  
HsinChu City 300, Taiwan, R.O.C

Tel: +886-3-5160181, Fax: +886-3-5160181

##### USA Office

##### BCD Semiconductor Corp.

48460 Kato Road, Fremont, CA 94538, USA  
Tel: +1-510-668-1950

Fax: +1-510-668-1990

##### Korea Office

##### BCD Semiconductor Limited Korea office.

Room 101-1112, Digital-Empire II, 486 Sin-dong,  
Yeongtong-Gu, Suwon-city, Gyeonggi-do, Korea

Tel: +82-31-695-8430

# Mouser Electronics

Authorized Distributor

Click to View Pricing, Inventory, Delivery & Lifecycle Information:

[Diodes Incorporated:](#)

[AP3211KTR-G1](#)