

## Product Summary

$BV_{DSS}$	$R_{DS(ON)}$ ( $\Omega$ )	$I_D$ (A)
60V	0.3 @ $V_{GS} = 10V$	1.6

## Description and Applications

This new generation of trench MOSFETs from Zetex utilizes a unique structure that combines the benefits of low on-resistance with fast switching speed. This makes them ideal for high efficiency, low voltage, power management applications.

- DC-AC Converters
- Motor Control

## Features

- Compact Package
- Low On State Losses
- Low Drive Requirements
- Operates up to 60V
- 1 Amp Continuous Rating
- **Lead-Free Finish; RoHS Compliant (Notes 1 & 2)**
- **Halogen and Antimony Free. "Green" Device (Note 3)**

## Mechanical Data

- Case: SM-8 (8 LEAD SOT223)
- Case Material: Molded Plastic, "Green" Molding Compound. UL Flammability Classification Rating 94V-0
- Moisture Sensitivity: Level 1 per J-STD-020
- Terminals: Finish - Matte Tin Plated Leads. Solderable per MIL-STD-202, Method 208 (3)
- Weight: 0.117 grams (Approximate)

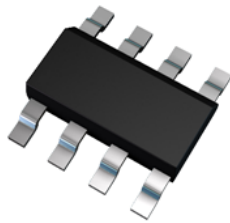

Top View

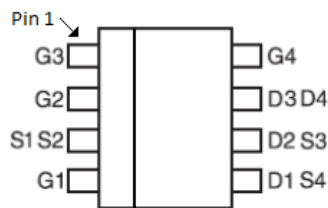

Top View  
Pin Out

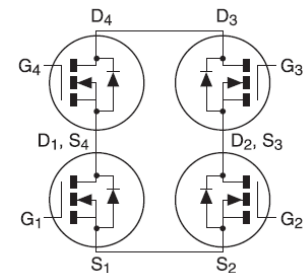

Equivalent Circuit

## Ordering Information (Note 4)

Part Number	Reel Size (inches)	Tape Width (mm)	Quantity per Reel
ZXMHN6A07T8TA	7	12	1,000
ZXMHN6A07T8TC	13	12	4,000

- Notes:
1. EU Directive 2002/95/EC (RoHS) & 2011/65/EU (RoHS 2) compliant. All applicable RoHS exemptions applied.
  2. See [http://www.diodes.com/quality/lead\\_free.html](http://www.diodes.com/quality/lead_free.html) for more information about Diodes Incorporated's definitions of Halogen- and Antimony-free, "Green" and Lead-free.
  3. Halogen- and Antimony-free "Green" products are defined as those which contain <900ppm bromine, <900ppm chlorine (<1500ppm total Br + Cl) and <1000ppm antimony compounds.
  4. For packaging details, go to our website at <http://www.diodes.com/products/packages.html>.

## Marking Information

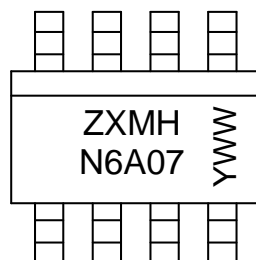

ZXMHN6A07 = Product Type Marking Code  
 YWW = Date Code Marking  
 Y or  $\bar{Y}$  = Last Digit of Year (ex: 5= 2015)  
 WW or  $\bar{W}W$  = Week Code (01 to 53)

### Absolute Maximum Ratings

Characteristic		Symbol	Value	Unit	
Drain-Source Voltage		$V_{DSS}$	60	V	
Gate-Source Voltage		$V_{GSS}$	$\pm 20$	V	
Continuous Drain Current	$V_{GS} = 10V$	$I_D$	$T_A = +25^\circ C$ (Notes 6, 8)	1.6	A
			$T_A = +70^\circ C$ (Notes 6, 8)	1.3	
			$T_A = +25^\circ C$ (Notes 5, 8)	1.4	
Pulsed Drain Current (Note 7)		$I_{DM}$	9	A	
Continuous Source Current (Body Diode) (Notes 6, 8)		$I_S$	1	A	
Pulsed Source Current (Body Diode) (Note 7)		$I_{SM}$	9	A	

### Thermal Characteristics

Characteristic		Symbol	Value	Unit
Total Power Dissipation at $T_A = +25^\circ C$	Any Single transistor "on" (Notes 5, 8)	$P_{TOT}$	1.1	W
	Single transistor 'on' (Notes 6, 8)		1.4	
	Two transistors 'on' equally (Notes 5, 9)		1.6	
Linear Derating Factor above $+25^\circ C$	Single transistor "on" (Notes 5, 8)	$P_{TOT}$	8.8	mW/ $^\circ C$
	Single transistor 'on' (Notes 6, 8)		11.2	
	Two transistors 'on' equally (Notes 5, 9)		13.2	
Thermal Resistance - Junction to Ambient	Single transistor "on" (Notes 5, 8)	$R_{\theta JA}$	114	$^\circ C/W$
	Single transistor "on" (Notes 6, 8)		89	
	Two transistors 'on' equally (Notes 5, 9)		76	
Operating and Storage Temperature Range		$T_J, T_{STG}$	-55 to +150	$^\circ C$

- Notes: 5. For a device mounted on 50mm x 50mm x 1.6mm FR-4 PCB with a high coverage of single sided 2oz weight copper in still air conditions with the heat sink split into three equal areas, one for each drain connection.  
6. For a device surface mounted on a FR-4 PCB at  $t \leq 10$  sec.  
7. Repetitive rating on 50mm x 50mm x 1.6mm FR-4 PCB, duty cycle 2%, pulse width 300 $\mu s$  in still air conditions with the heat sink split into three equal areas, one for each drain connection.  
8. For device with one active die.  
9. For any two die not sharing the same drain connection.

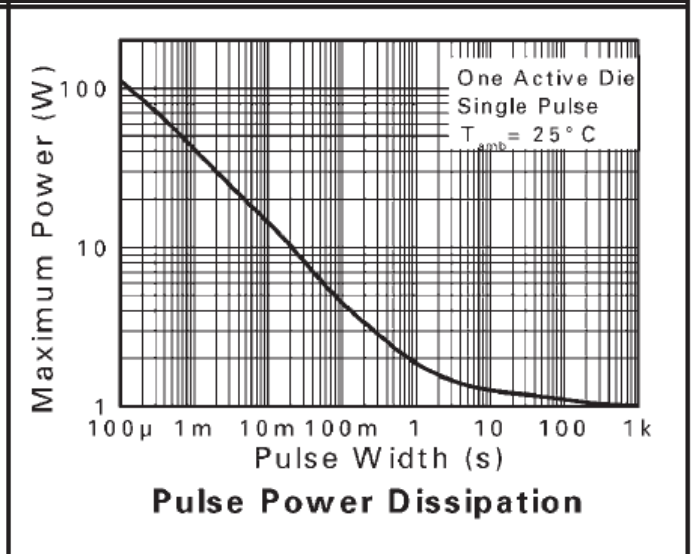
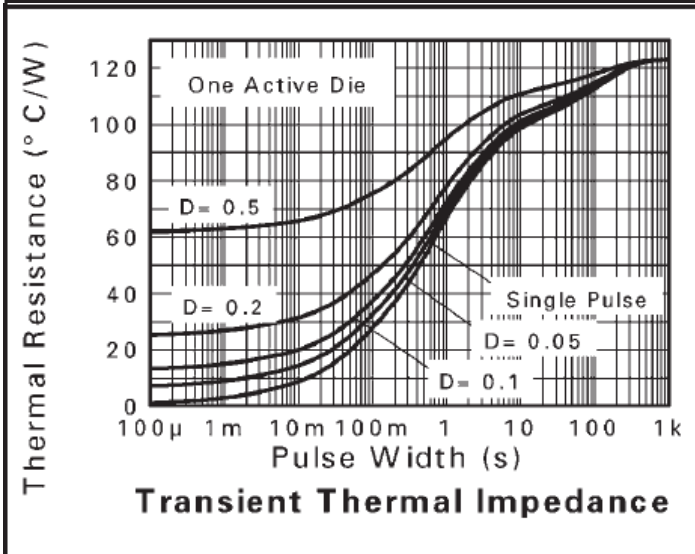
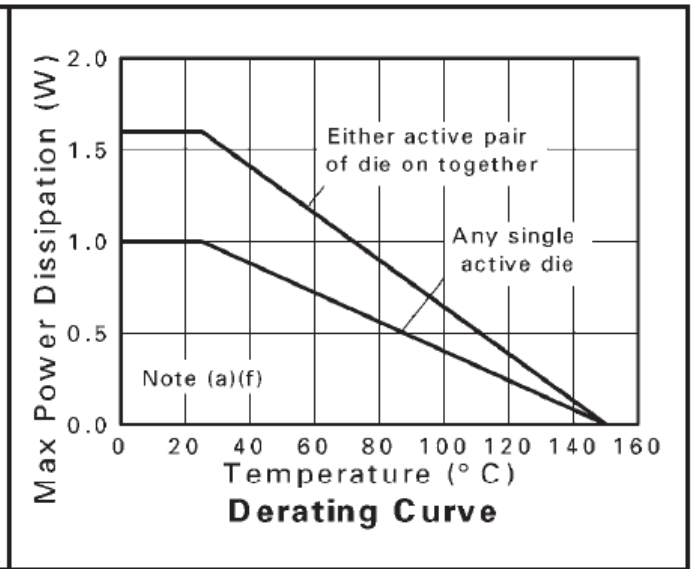
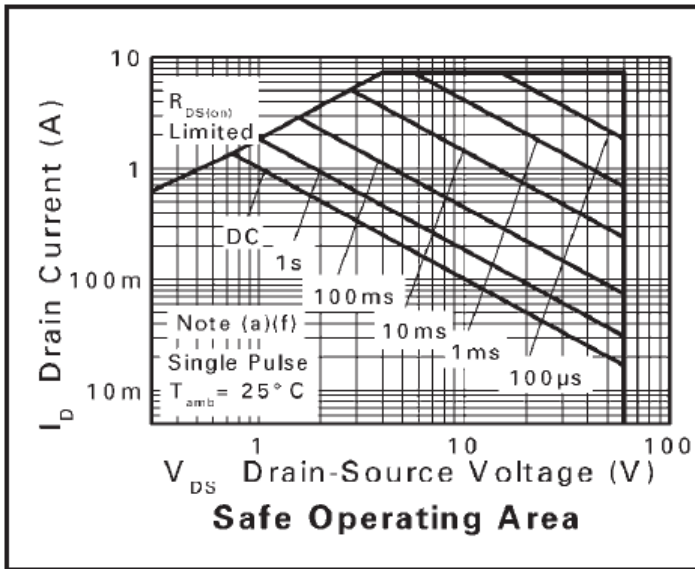

**Electrical Characteristics** (@T<sub>A</sub> = +25°C, unless otherwise specified.)

Characteristic	Symbol	Min	Typ	Max	Unit	Test Condition
<b>STATIC</b>						
Drain-Source Breakdown Voltage	BV <sub>DSS</sub>	60	–	–	V	V <sub>GS</sub> = 0V, I <sub>D</sub> = 250μA
Zero Gate Voltage Drain Current	I <sub>DSS</sub>	–	–	1.0	μA	V <sub>DS</sub> = 60V, V <sub>GS</sub> = 0V
Gate-Source Leakage	I <sub>GSS</sub>	–	–	100	nA	V <sub>GS</sub> = ±20V, V <sub>DS</sub> = 0V
Gate Threshold Voltage	V <sub>GS(TH)</sub>	1.0	–	3.0	V	V <sub>DS</sub> = V <sub>GS</sub> , I <sub>D</sub> = 250μA
Static Drain-Source On-State Resistance (Note 10)	R <sub>DS(ON)</sub>	–	–	0.3	Ω	V <sub>GS</sub> = 10V, I <sub>D</sub> = 1.8A
		–	–	0.45	Ω	V <sub>GS</sub> = 4.5V, I <sub>D</sub> = 1.3A
Forward Transconductance (Notes 10,12)	g <sub>fs</sub>	–	2.3	–	S	V <sub>DS</sub> = 15V, I <sub>D</sub> = 1.8A
<b>DYNAMIC (Note 12)</b>						
Input Capacitance	C <sub>iss</sub>	–	166	–	pF	V <sub>DS</sub> = 40V, V <sub>GS</sub> = 0V, f = 1MHz
Output Capacitance	C <sub>oss</sub>	–	20	–	pF	
Reverse Transfer Capacitance	C <sub>rss</sub>	–	9	–	pF	
<b>SWITCHING (Notes 11, 12)</b>						
Turn-On Delay Time	t <sub>D(ON)</sub>	–	1.8	–	ns	V <sub>DD</sub> = 30V, I <sub>D</sub> = 1.8A R <sub>G</sub> ≈ 6.0Ω, V <sub>GS</sub> = 10V
Turn-On Rise Time	t <sub>R</sub>	–	1.4	–	ns	
Turn-Off Delay Time	t <sub>D(OFF)</sub>	–	4.9	–	ns	
Turn-Off Fall Time	t <sub>F</sub>	–	2.0	–	ns	V <sub>DS</sub> = 30V, V <sub>GS</sub> = 10V I <sub>D</sub> = 1.8A
Gate Charge	Q <sub>g</sub>	–	3.2	–	nC	
Gate-Source Charge	Q <sub>gs</sub>	–	0.7	–	nC	
Gate Drain Charge	Q <sub>gd</sub>	–	0.8	–	nC	
<b>Source-Drain Diode</b>						
Diode Forward Voltage (Note 10)	V <sub>SD</sub>	–	–	0.95	V	T <sub>J</sub> = +25°C, I <sub>S</sub> = 0.45A, V <sub>GS</sub> = 0V
Reverse Recovery Time (Note 12)	t <sub>RR</sub>	–	21	–	ns	T <sub>J</sub> = +25°C, I <sub>S</sub> = 1.0A, di/dt = 100A/μs
Reverse Recovery Charge (Note 12)	Q <sub>RR</sub>	–	21	–	nC	

- Notes: 10. Measured under pulsed conditions. Pulse width ≤ 300μs; duty cycle ≤ 2%.  
 11. Switching characteristics are independent of operating junction temperature.  
 12. For design aid only, not subject to production testing.

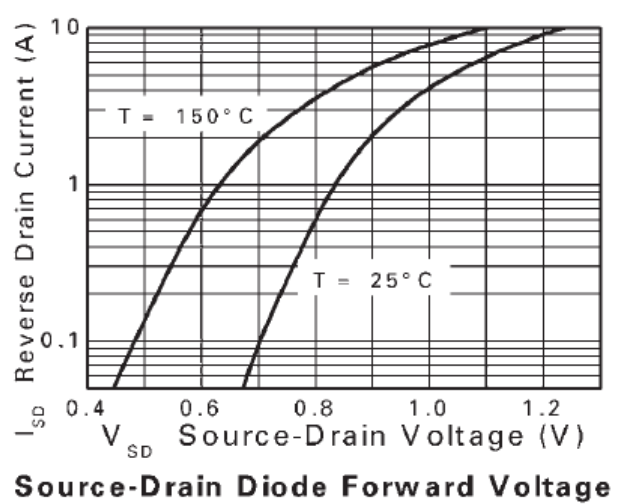
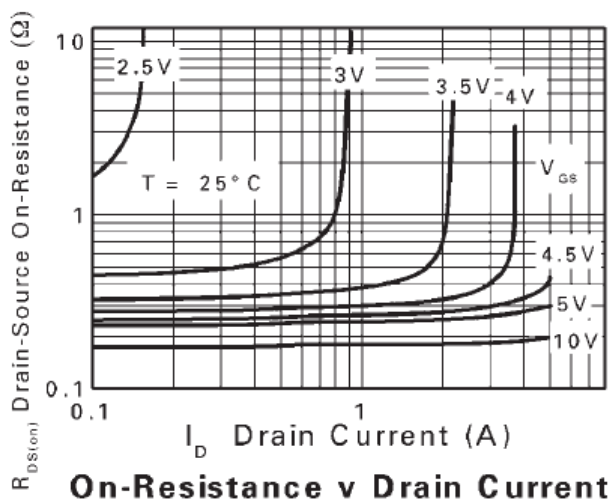
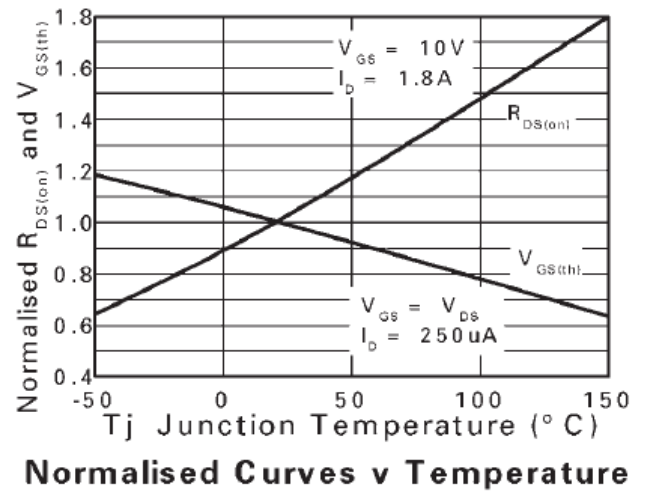
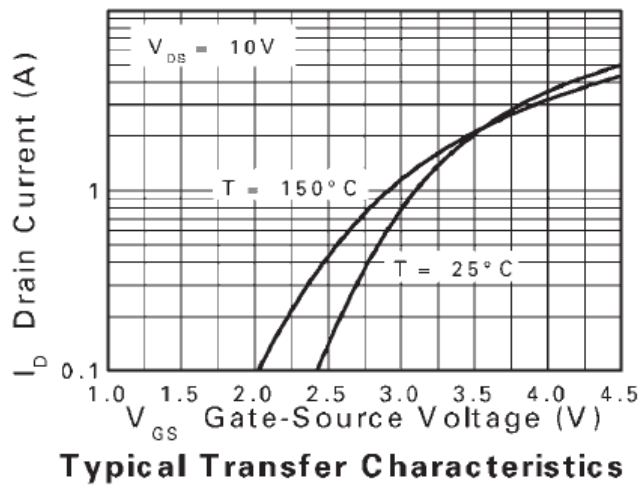
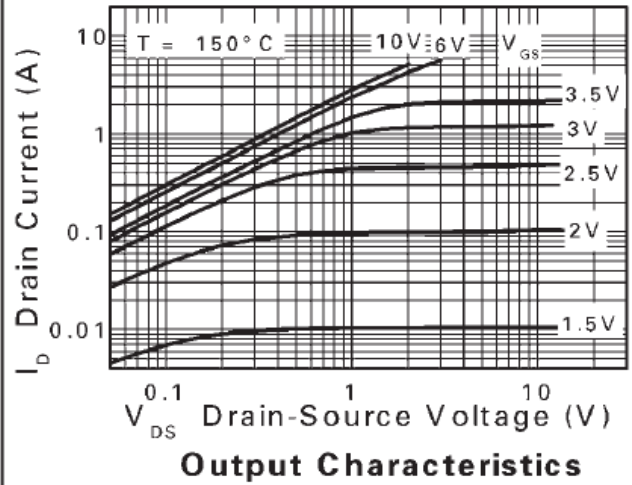
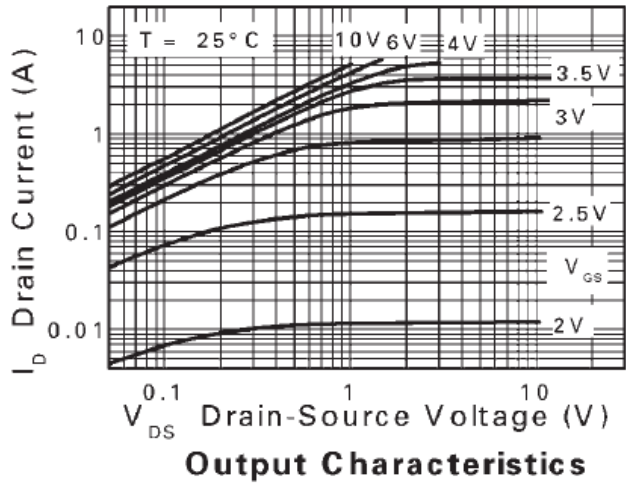

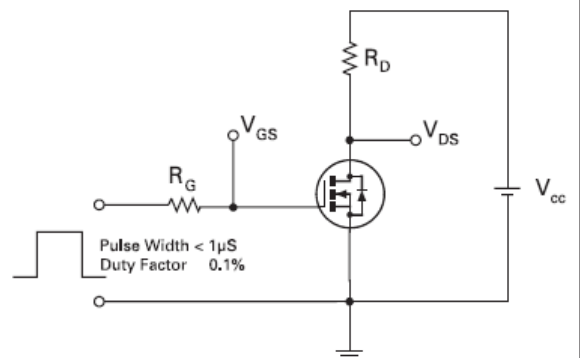
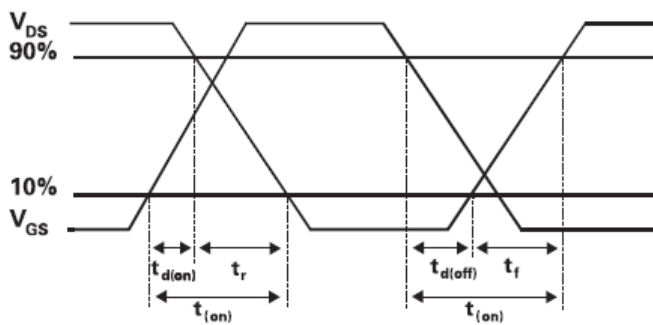
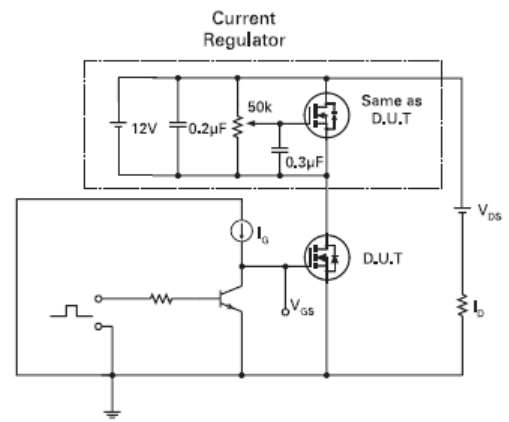
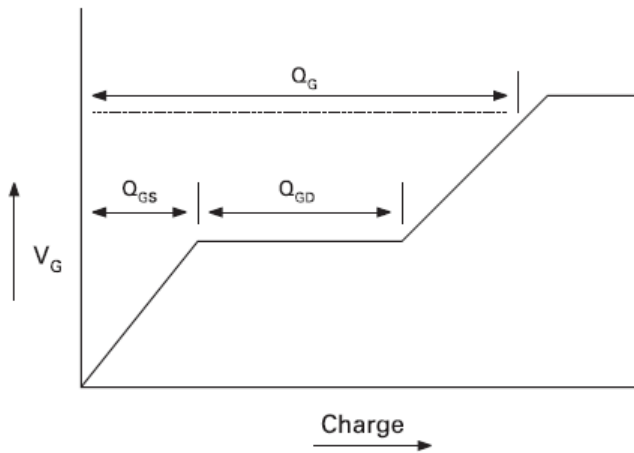
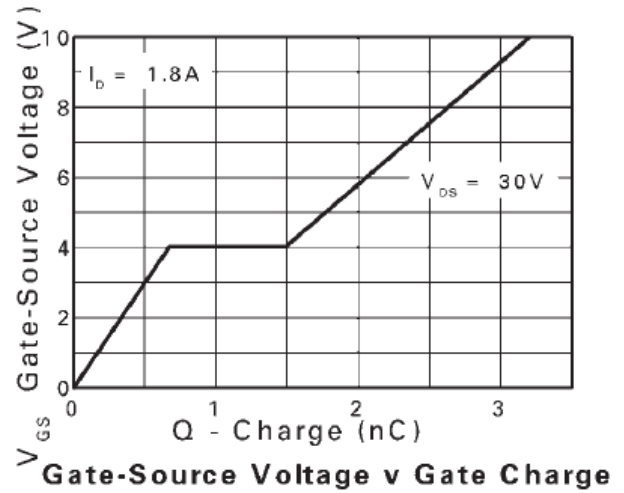
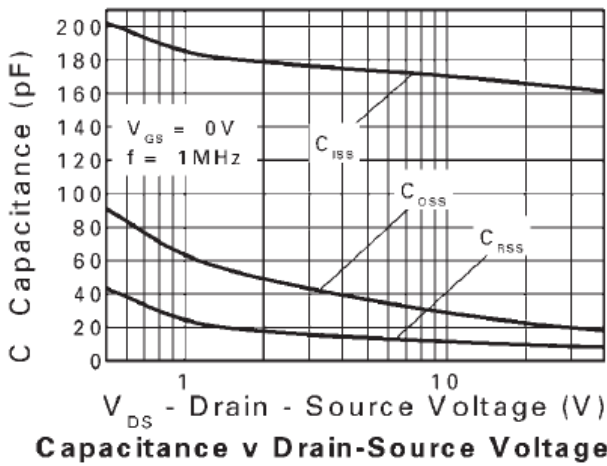

## Package Outline Dimensions

Please see AP02002 at <http://www.diodes.com/datasheets/ap02002.pdf> for the latest version.

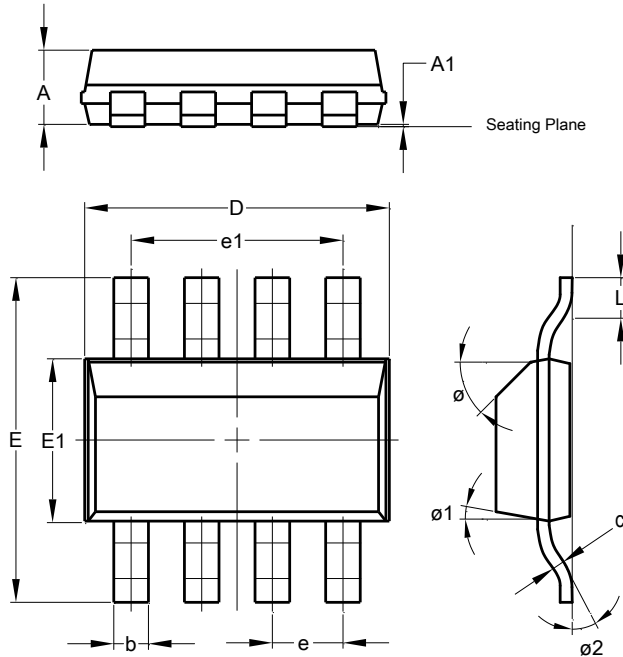

SM-8			
Dim	Min	Max	Typ
A	--	1.70	1.60
A1	0.02	0.10	0.04
b	0.70	0.90	0.80
c	0.24	0.32	0.28
D	6.30	6.70	6.60
e	1.53 REF		
e1	4.59 REF		
E	6.70	7.30	7.00
E1	3.30	3.70	3.50
L	0.75	1.00	0.90
Ø	--	--	45°
Ø1	--	15°	--
Ø2	--	--	10°
All Dimensions in mm			

## Suggested Pad Layout

Please see AP02001 at <http://www.diodes.com/datasheets/ap02001.pdf> for the latest version.

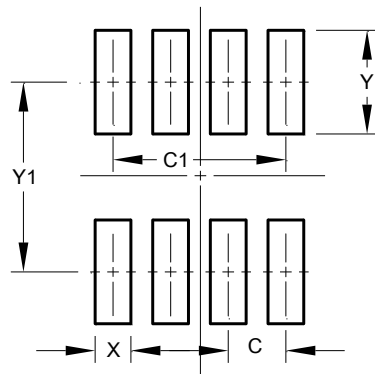

Dimensions	Value (in mm)
C	1.52
C1	4.60
X	0.95
Y	2.80
Y1	6.80

**IMPORTANT NOTICE**

DIODES INCORPORATED MAKES NO WARRANTY OF ANY KIND, EXPRESS OR IMPLIED, WITH REGARDS TO THIS DOCUMENT, INCLUDING, BUT NOT LIMITED TO, THE IMPLIED WARRANTIES OF MERCHANTABILITY AND FITNESS FOR A PARTICULAR PURPOSE (AND THEIR EQUIVALENTS UNDER THE LAWS OF ANY JURISDICTION).

Diodes Incorporated and its subsidiaries reserve the right to make modifications, enhancements, improvements, corrections or other changes without further notice to this document and any product described herein. Diodes Incorporated does not assume any liability arising out of the application or use of this document or any product described herein; neither does Diodes Incorporated convey any license under its patent or trademark rights, nor the rights of others. Any Customer or user of this document or products described herein in such applications shall assume all risks of such use and will agree to hold Diodes Incorporated and all the companies whose products are represented on Diodes Incorporated website, harmless against all damages.

Diodes Incorporated does not warrant or accept any liability whatsoever in respect of any products purchased through unauthorized sales channel. Should Customers purchase or use Diodes Incorporated products for any unintended or unauthorized application, Customers shall indemnify and hold Diodes Incorporated and its representatives harmless against all claims, damages, expenses, and attorney fees arising out of, directly or indirectly, any claim of personal injury or death associated with such unintended or unauthorized application.

Products described herein may be covered by one or more United States, international or foreign patents pending. Product names and markings noted herein may also be covered by one or more United States, international or foreign trademarks.

This document is written in English but may be translated into multiple languages for reference. Only the English version of this document is the final and determinative format released by Diodes Incorporated.

**LIFE SUPPORT**

Diodes Incorporated products are specifically not authorized for use as critical components in life support devices or systems without the express written approval of the Chief Executive Officer of Diodes Incorporated. As used herein:

A. Life support devices or systems are devices or systems which:

1. are intended to implant into the body, or
2. support or sustain life and whose failure to perform when properly used in accordance with instructions for use provided in the labeling can be reasonably expected to result in significant injury to the user.

B. A critical component is any component in a life support device or system whose failure to perform can be reasonably expected to cause the failure of the life support device or to affect its safety or effectiveness.

Customers represent that they have all necessary expertise in the safety and regulatory ramifications of their life support devices or systems, and acknowledge and agree that they are solely responsible for all legal, regulatory and safety-related requirements concerning their products and any use of Diodes Incorporated products in such safety-critical, life support devices or systems, notwithstanding any devices- or systems-related information or support that may be provided by Diodes Incorporated. Further, Customers must fully indemnify Diodes Incorporated and its representatives against any damages arising out of the use of Diodes Incorporated products in such safety-critical, life support devices or systems.

Copyright © 2015, Diodes Incorporated

[www.diodes.com](http://www.diodes.com)



# Mouser Electronics

Authorized Distributor

Click to View Pricing, Inventory, Delivery & Lifecycle Information:

[Diodes Incorporated:](#)

[ZXMHN6A07T8TA](#)