

General Description

- DCX4710H is best suited for applications where the load needs to be turned on and off using micro-controllers, comparators or other control circuits, particularly at a point of load. It features a discrete pre-biased PNP transistor which can support continuous maximum current of 100 mA. It also contains a pre-biased NPN transistor which can be used as a control and can be biased using a higher supply. The component devices can be used as a part of circuit or as stand alone discrete devices.

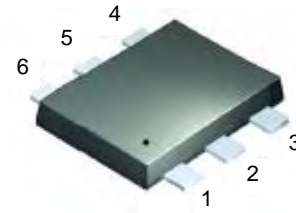

SOT-563

Features

- Built in Biasing Resistors
- Epitaxial Planar Die Construction
- Ideally Suited for Automated Assembly Processes
- Lead Free By Design/RoHS Compliant (Note 1)**
- "Green" Device (Note 2)**

Mechanical Data

- Case: SOT-563
- Case Material: Molded Plastic. "Green Molding" Compound. UL Flammability Classification Rating 94V-0
- Moisture Sensitivity: Level 1 per J-STD-020C
- Terminal Connections: See Fig. 2
- Terminals: Finish - Matte Tin annealed over Copper leadframe. Solderable per MIL-STD-202, Method 208
- Marking & Type Code Information: See Page 7
- Ordering Information: See Page 7
- Weight: 0.005 grams (approximate)

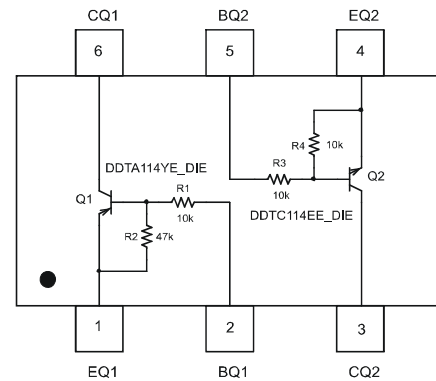

Schematic and Pin Configuration

Reference	Device Type	R1 (NOM)	R2 (NOM)	R3 (NOM)	R4 (NOM)
Q1	PNP	10KΩ	47KΩ	—	—
Q2	NPN	—	—	10KΩ	10KΩ

Maximum Ratings: Total Device @T_A = 25°C unless otherwise specified

Characteristic	Symbol	Value	Unit
Output Current	I _{out}	100	mA
Power Dissipation (Note 3)	P _d	150	mW
Power Derating Factor above 45°C	P _{der}	1.43	mW/°C
Junction Operation and Storage Temperature Range	P _d	-55 to +150	°C
Thermal Resistance, Junction to Ambient Air (Note 3) (Equivalent to one heated junction of PNP transistor) @ T _A = 25°C	R _{θJA}	833	°C/W

- Notes:
- No purposefully added lead.
 - Diodes Inc.'s "Green" policy can be found on our website at http://www.diodes.com/products/lead_free/index.php.
 - Device mounted on FR-4 PCB, 1 inch x 0.85 inch x 0.062 inch; as per Diodes Inc. suggested pad layout document AP02001 on our website at <http://www.diodes.com/datasheets/ap02001.pdf>.

Sub-Component Device – Pre-Biased PNP Transistor (Q1) @ $T_A = 25^\circ\text{C}$ unless otherwise specified

Characteristic	Symbol	Value	Unit
Collector-Base Voltage	V_{CBO}	-50	V
Collector-Emitter Voltage	V_{CEO}	-50	V
Supply Voltage	V_{CC}	-50	V
Input Voltage	V_{IN}	+6 to -40	V
Output Current (dc)	$I_{C(max)}$	-100	mA

Sub-Component Device – Pre-Biased NPN Transistor (Q2) @ $T_A = 25^\circ\text{C}$ unless otherwise specified

Characteristic	Symbol	Value	Unit
Collector-Base Voltage	V_{CBO}	50	V
Collector-Emitter Voltage	V_{CEO}	50	V
Supply Voltage	V_{CC}	50	V
Input Voltage	V_{IN}	-10 to +40	V
Output Current (dc)	$I_{C(max)}$	100	mA

Electrical Characteristics: Pre-Biased PNP Transistor (Q1) @ $T_A = 25^\circ\text{C}$ unless otherwise specified

Characteristic	Symbol	Min	Typ	Max	Unit	Test Condition
OFF CHARACTERISTICS						
Collector-Base Cut Off Current	I_{CBO}	—	—	-100	nA	$V_{CB} = -50\text{V}, I_E = 0$
Collector-Base Breakdown Voltage	$V_{(BR)CBO}$	-50	—	—	V	$I_C = -10\mu\text{A}, I_E = 0$
Collector-Emitter Breakdown Voltage	$V_{(BR)CEO}$	-50	—	—	V	$I_C = -4\text{mA}, I_B = 0$
Input Off Voltage	$V_{I(OFF)}$	—	—	-0.3	V	$V_{CE} = -5\text{V}, I_C = -100\mu\text{A}$
Output Off Current	$I_{O(OFF)}$	—	—	-0.5	μA	$V_{CC} = -50\text{V}, V_I = 0\text{V}$
ON CHARACTERISTICS						
DC Current Gain	h_{FE}	80	—	—	—	$V_{CE} = -5\text{V}, I_C = -5\text{mA}$
Collector-Emitter Saturation Voltage	$V_{CE(sat)}$	—	—	-0.25	V	$I_C = -10\text{mA}, I_B = -0.3\text{mA}$
Output On Voltage	$V_{O(ON)}$	—	-0.1	-0.3	V	$I_O/I_I = -10\text{mA}/-0.5\text{mA}$
Input On Voltage (Load is present)	$V_{I(ON)}$	-1.4	-0.9	—	V	$V_O = -0.3\text{V}, I_C = -2\text{mA}$
Input Current	I_I	—	—	-0.88	mA	$V_I = -5\text{V}$
Input Resistor +/- 30% (Base)	$\Delta R1$	7	10	13	$\text{K}\Omega$	—
Pull-up Resistor (Base to Vcc supply)	R2	32	47	62	$\text{K}\Omega$	—
Resistor Ratio	$\Delta(R2/R1)$	20	—	20	%	—
SMALL SIGNAL CHARACTERISTICS						
Transition Frequency (gain bandwidth product)	f_T	—	250	—	MHz	$V_{CE} = -10\text{V}, I_E = -5\text{mA}, f = 100\text{MHz}$

*Pulse Test: Pulse width, $t_p < 300 \mu\text{s}$, Duty Cycle, $d < 0.02$

Pre-Biased NPN Transistor (Q2) @T_A = 25°C unless otherwise specified

Characteristic	Symbol	Min	Typ	Max	Unit	Test Condition
OFF CHARACTERISTICS						
Collector-Base Cut Off Current	I _{CBO}	—	—	100	nA	V _{CB} = 50V, I _E = 0
Collector-Base Breakdown Voltage	V _{(BR)CBO}	50	—	—	V	I _C = 10μA, I _E = 0
Collector-Emitter Breakdown Voltage	V _{(BR)CEO}	50	—	—	V	I _C = 2mA, I _B = 0
Input Off Voltage	V _{I(OFF)}	—	1.2	0.5	V	V _{CE} = 5V, I _C = 100μA
Output Current	I _{O(OFF)}	—	—	0.5	μA	V _{CC} = 50V, V _I = 0V
ON CHARACTERISTICS						
DC Current Gain	h _{FE}	35	—	—	—	V _{CE} = 5V, I _C = 5mA
Collector-Emitter Saturation Voltage	V _{CE(sat)}	—	—	0.25	V	I _C = -10mA, I _B = -0.3mA
Output On Voltage	V _{O(ON)}	—	0.1	0.3	V	I _O /I _I = 10mA/0.5mA
Input On Voltage	V _{I(ON)}	3	1.6	—	V	V _O = 0.3V, I _C = 2mA
Input Current	I _I	—	—	0.88	mA	V _I = 5V
Input Resistor +/- 30% (Base)	R1	7	10	13	KΩ	—
Resistor Ratio	(R2/R1)	0.8	1	1.2	—	—
SMALL SIGNAL CHARACTERISTICS						
Transition Frequency (Gain bandwidth product)	f _T	—	250	—	MHz	V _{CE} = 10V, I _E = 5mA, f = 100MHz

*Pulse Test: Pulse width, tp<300 uS, Duty Cycle, d<=0.02

Typical Characteristics @T_{amb} = 25°C unless otherwise specified

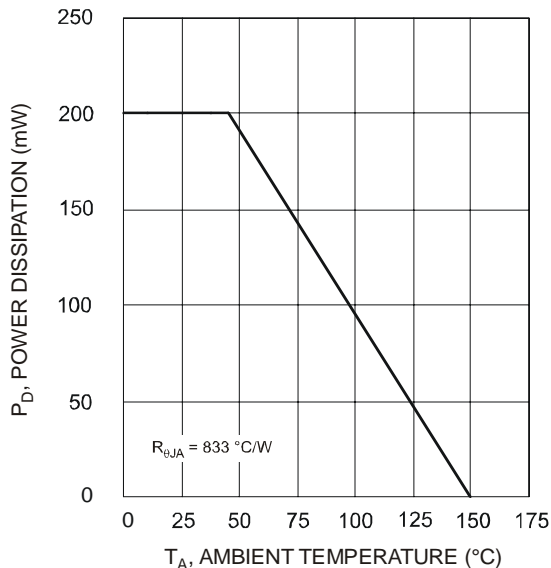

Fig. 1 Power Derating Curve (Note 3)

Notes: 3. Device mounted on FR-4 PCB, 1 inch x 0.85 inch x 0.062 inch; as per Diodes Inc. suggested pad layout document AP02001 on our website at <http://www.diodes.com/datasheets/ap02001.pdf>.

Characteristics Curves of PNP Transistor (Q1) @ $T_{amb} = 25^{\circ}C$ unless otherwise specified

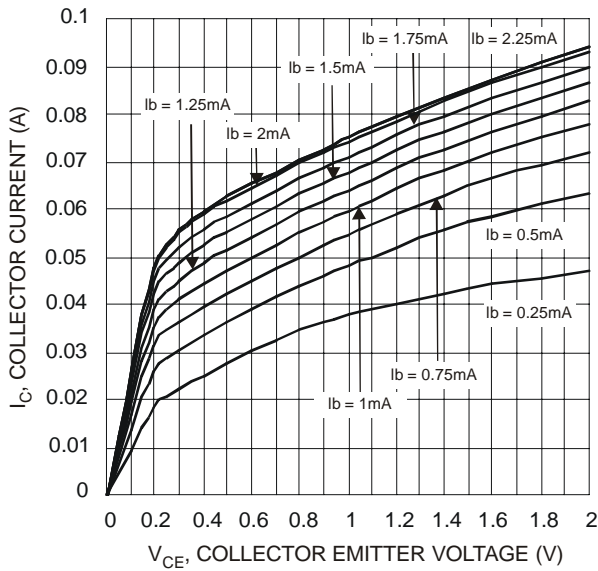

Fig. 2 V_{CE} vs. I_C

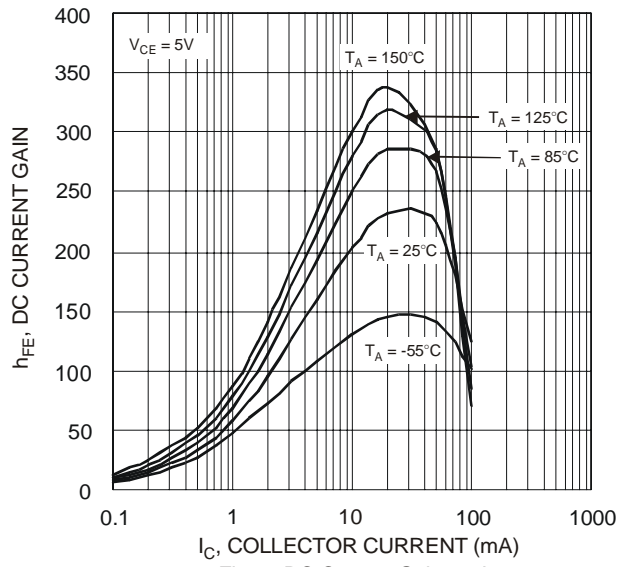

Fig. 3 DC Current Gain vs. I_C

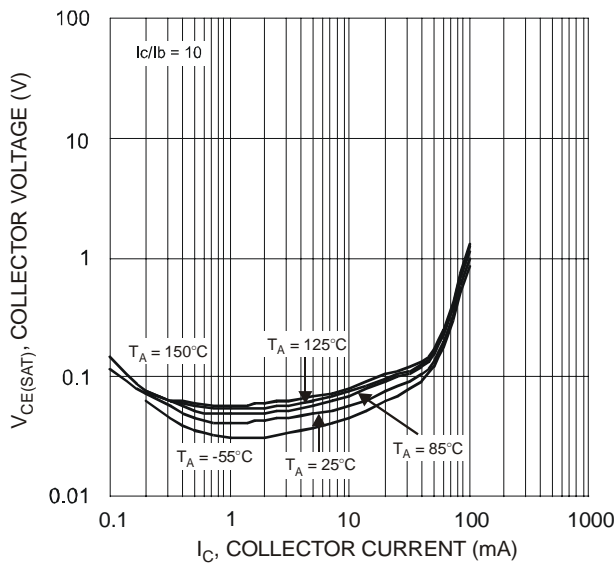

Fig. 4 I_C vs. $V_{CE(SAT)}$

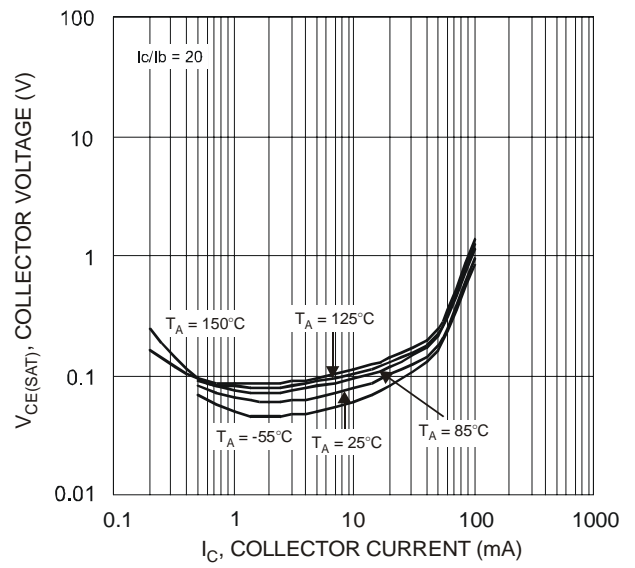

Fig. 5 I_C vs. $V_{CE(SAT)}$

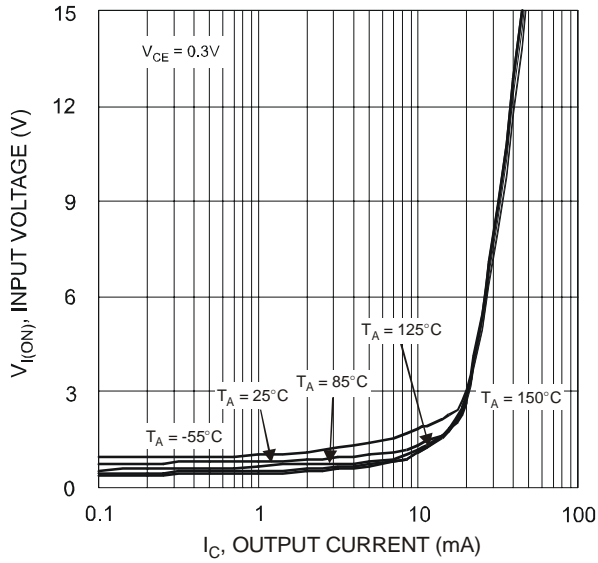

Fig. 6 Input Voltage vs. Collector Current

Characteristics Curves of NPN Transistor (Q2) @ $T_{amb} = 25^\circ\text{C}$ unless otherwise specified

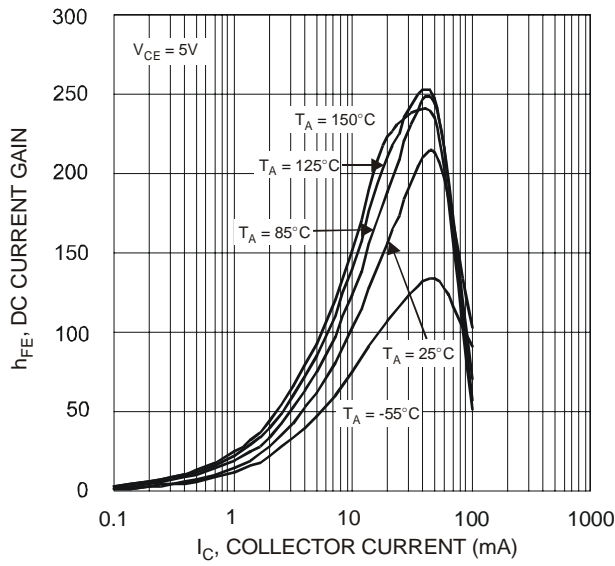

Fig. 7 DC Current Gain vs. I_C

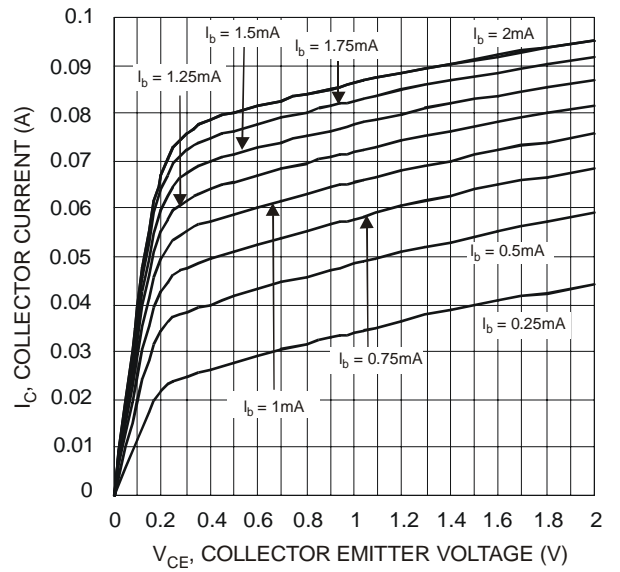

Fig. 8 V_{CE} vs. I_C

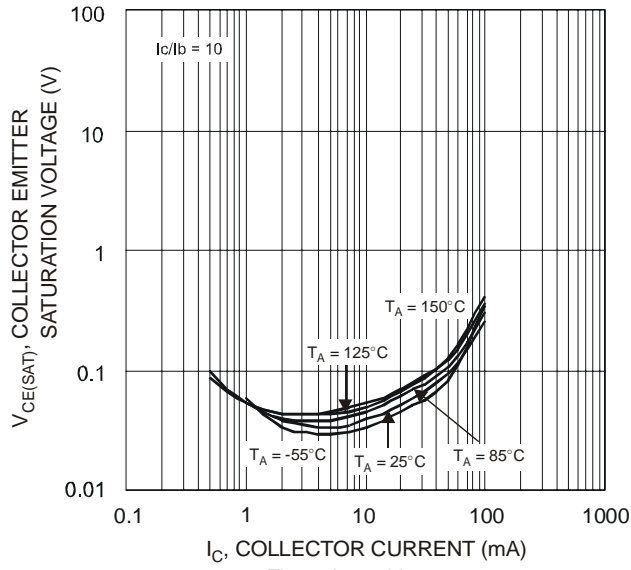

Fig. 9 I_C vs. $V_{CE(SAT)}$

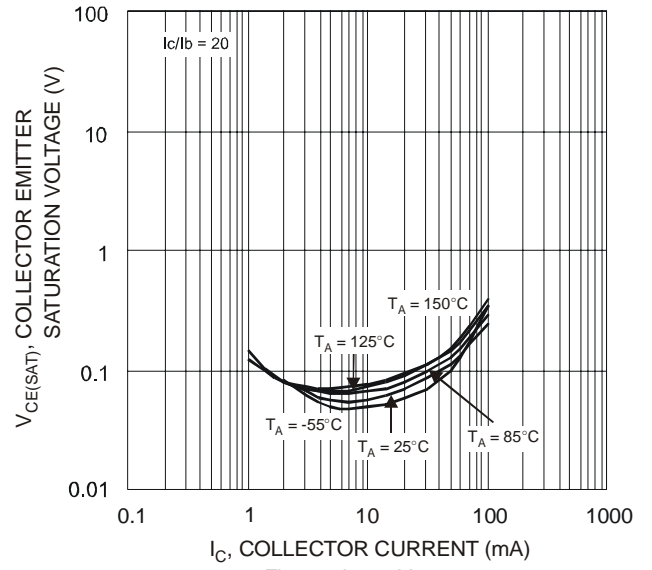

Fig. 10 I_C vs. $V_{CE(SAT)}$

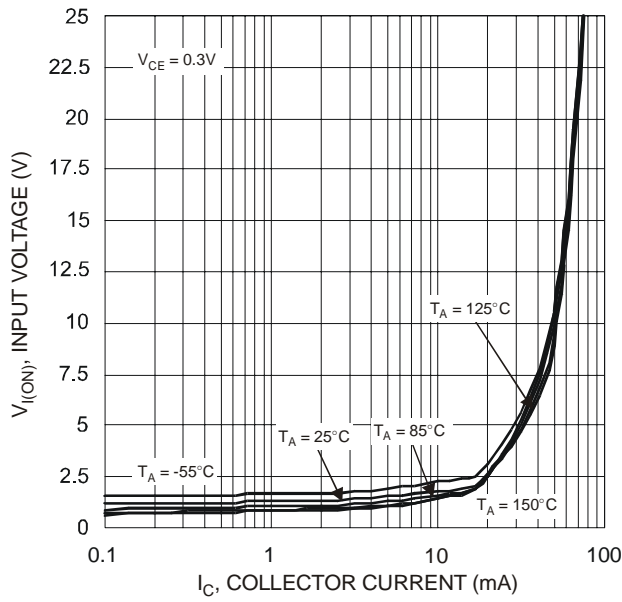

Fig. 11 Input Voltage vs. Output Current

Ordering Information (Note 5)

Device	Marking Code	Packaging	Shipping
DCX4710H-7	C02	SOT-563	3000/Tape & Reel

Notes: 5. For Packaging Details, go to our website at <http://www.diodes.com/datasheets/ap02007.pdf>.

Marking Information

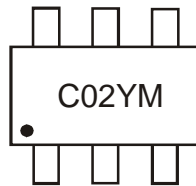

C02 = Product Type Marking Code
 YM = Date Code Marking
 Y = Year e.g., T = 2006
 M = Month e.g., 9 = September

Fig. 12

Date Code Key

Year	2006	2007	2008	2009	2010	2011	2012
Code	T	U	V	W	X	Y	Z

Month	Jan	Feb	Mar	Apr	May	Jun	Jul	Aug	Sep	Oct	Nov	Dec
Code	1	2	3	4	5	6	7	8	9	O	N	D

IMPORTANT NOTICE

Diodes Incorporated and its subsidiaries reserve the right to make modifications, enhancements, improvements, corrections or other changes without further notice to any product herein. Diodes Incorporated does not assume any liability arising out of the application or use of any product described herein; neither does it convey any license under its patent rights, nor the rights of others. The user of products in such applications shall assume all risks of such use and will agree to hold Diodes Incorporated and all the companies whose products are represented on our website, harmless against all damages.

LIFE SUPPORT

Diodes Incorporated products are not authorized for use as critical components in life support devices or systems without the expressed written approval of the President of Diodes Incorporated.

Mouser Electronics

Authorized Distributor

Click to View Pricing, Inventory, Delivery & Lifecycle Information:

[Diodes Incorporated:](#)

[DCX4710H-7](#)