



April 2015

## 4N25M, 4N26M, 4N27M, 4N28M, 4N35M, 4N36M, 4N37M 6-Pin General Purpose Phototransistor Optocouplers

### Features

- Minimum Current Transfer Ratio at  $I_F = 10 \text{ mA}$ ,  $V_{CE} = 10 \text{ V}$ :
  - 10% for 4N27M and 4N28M
  - 20% for 4N25M and 4N26M
  - 100% for 4N35M, 4N36M and 4N37M
- Safety and Regulatory Approvals:
  - UL1577, 4,170  $V_{AC_{RMS}}$  for 1 Minute
  - DIN-EN/IEC60747-5-5, 850 V Peak Working Insulation Voltage

### Applications

- Power Supply Regulators
- Digital Logic Inputs
- Microprocessor Inputs

### Description

The general purpose optocouplers consist of a gallium arsenide infrared emitting diode driving a silicon phototransistor in a standard plastic six-pin dual-in-line package.

### Schematic

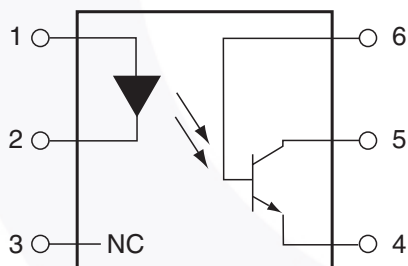

- PIN 1. ANODE  
2. CATHODE  
3. NO CONNECTION  
4. EMITTER  
5. COLLECTOR  
6. BASE

Figure 1. Schematic

### Package Outlines

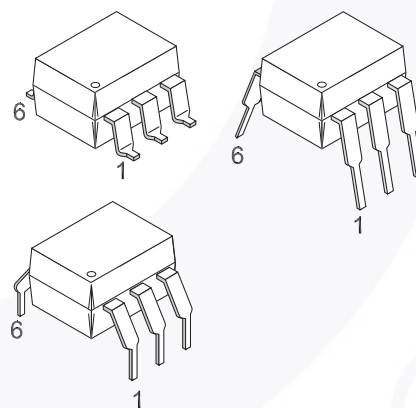

Figure 2. Package Outlines

4N25M, 4N26M, 4N27M, 4N28M, 4N35M, 4N36M, 4N37M — 6-Pin General Purpose Phototransistor Optocouplers

## Safety and Insulation Ratings

As per DIN EN/IEC 60747-5-5, this optocoupler is suitable for “safe electrical insulation” only within the safety limit data. Compliance with the safety ratings shall be ensured by means of protective circuits.

Parameter		Characteristics
Installation Classifications per DIN VDE 0110/1.89 Table 1, For Rated Mains Voltage	< 150 V <sub>RMS</sub>	I–IV
	< 300 V <sub>RMS</sub>	I–IV
Climatic Classification		55/100/21
Pollution Degree (DIN VDE 0110/1.89)		2
Comparative Tracking Index		175

Symbol	Parameter	Value	Unit
V <sub>PR</sub>	Input-to-Output Test Voltage, Method A, V <sub>IORM</sub> × 1.6 = V <sub>PR</sub> , Type and Sample Test with t <sub>m</sub> = 10 s, Partial Discharge < 5 pC	1360	V <sub>peak</sub>
	Input-to-Output Test Voltage, Method B, V <sub>IORM</sub> × 1.875 = V <sub>PR</sub> , 100% Production Test with t <sub>m</sub> = 1 s, Partial Discharge < 5 pC	1594	V <sub>peak</sub>
V <sub>IORM</sub>	Maximum Working Insulation Voltage	850	V <sub>peak</sub>
V <sub>IOTM</sub>	Highest Allowable Over-Voltage	6000	V <sub>peak</sub>
	External Creepage	≥ 7	mm
	External Clearance	≥ 7	mm
	External Clearance (for Option TV, 0.4" Lead Spacing)	≥ 10	mm
DTI	Distance Through Insulation (Insulation Thickness)	≥ 0.5	mm
T <sub>S</sub>	Case Temperature <sup>(1)</sup>	175	°C
I <sub>S,INPUT</sub>	Input Current <sup>(1)</sup>	350	mA
P <sub>S,OUTPUT</sub>	Output Power <sup>(1)</sup>	800	mW
R <sub>IO</sub>	Insulation Resistance at T <sub>S</sub> , V <sub>IO</sub> = 500 V <sup>(1)</sup>	> 10 <sup>9</sup>	Ω

### Note:

1. Safety limit values – maximum values allowed in the event of a failure.

## Absolute Maximum Ratings

Stresses exceeding the absolute maximum ratings may damage the device. The device may not function or be operable above the recommended operating conditions and stressing the parts to these levels is not recommended. In addition, extended exposure to stresses above the recommended operating conditions may affect device reliability. The absolute maximum ratings are stress ratings only.  $T_A = 25^\circ\text{C}$  unless otherwise specified.

Symbol	Parameter	Value	Unit
<b>TOTAL DEVICE</b>			
$T_{STG}$	Storage Temperature	-40 to +125	$^\circ\text{C}$
$T_{OPR}$	Operating Temperature	-40 to +100	$^\circ\text{C}$
$T_J$	Junction Temperature	-40 to +125	$^\circ\text{C}$
$T_{SOL}$	Lead Solder Temperature	260 for 10 seconds	$^\circ\text{C}$
$P_D$	Total Device Power Dissipation @ $T_A = 25^\circ\text{C}$	270	mW
	Derate Above $25^\circ\text{C}$	2.94	mW/ $^\circ\text{C}$
<b>EMITTER</b>			
$I_F$	DC/Average Forward Input Current	60	mA
$V_R$	Reverse Input Voltage	6	V
$I_F(\text{pk})$	Forward Current – Peak (300 $\mu\text{s}$ , 2% Duty Cycle)	3	A
$P_D$	LED Power Dissipation @ $T_A = 25^\circ\text{C}$	120	mW
	Derate Above $25^\circ\text{C}$	1.41	mW/ $^\circ\text{C}$
<b>DETECTOR</b>			
$V_{CEO}$	Collector-to-Emitter Voltage	30	V
$V_{CBO}$	Collector-to-Base Voltage	70	V
$V_{ECO}$	Emitter-to-Collector Voltage	7	V
$P_D$	Detector Power Dissipation @ $T_A = 25^\circ\text{C}$	150	mW
	Derate Above $25^\circ\text{C}$	1.76	mW/ $^\circ\text{C}$

## Electrical Characteristics

TA = 25°C unless otherwise specified.

### Individual Component Characteristics

Symbol	Parameter	Test Conditions	Min.	Typ.	Max.	Unit
<b>EMITTER</b>						
V <sub>F</sub>	Input Forward Voltage	I <sub>F</sub> = 10 mA		1.18	1.50	V
I <sub>R</sub>	Reverse Leakage Current	V <sub>R</sub> = 6.0 V		0.001	10	μA
<b>DETECTOR</b>						
BV <sub>CEO</sub>	Collector-to-Emitter Breakdown Voltage	I <sub>C</sub> = 1.0 mA, I <sub>F</sub> = 0	30	100		V
BV <sub>CBO</sub>	Collector-to-Base Breakdown Voltage	I <sub>C</sub> = 100 μA, I <sub>F</sub> = 0	70	120		V
BV <sub>ECO</sub>	Emitter-to-Collector Breakdown Voltage	I <sub>E</sub> = 100 μA, I <sub>F</sub> = 0	7	10		V
I <sub>CEO</sub>	Collector-to-Emitter Dark Current	V <sub>CE</sub> = 10 V, I <sub>F</sub> = 0		1	50	nA
I <sub>CBO</sub>	Collector-to-Base Dark Current	V <sub>CB</sub> = 10 V			20	nA
C <sub>CE</sub>	Capacitance	V <sub>CE</sub> = 0 V, f = 1 MHz		8		pF

### Transfer Characteristics

Symbol	Parameter	Test Conditions	Device	Min.	Typ.	Max.	Unit
<b>DC CHARACTERISTICS</b>							
CTR	Current Transfer Ratio, Collector-to-Emitter	I <sub>F</sub> = 10 mA, V <sub>CE</sub> = 10 V	4N35M, 4N36M, 4N37M	100			%
			4N25M, 4N26M	20			%
			4N27M, 4N28M	10			%
		I <sub>F</sub> = 10 mA, V <sub>CE</sub> = 10 V, T <sub>A</sub> = -55°C	4N35M, 4N36M, 4N37M	40			%
I <sub>F</sub> = 10 mA, V <sub>CE</sub> = 10 V, T <sub>A</sub> = +100°C	4N35M, 4N36M, 4N37M	40			%		
V <sub>CE (SAT)</sub>	Collector-to-Emitter Saturation Voltage	I <sub>C</sub> = 2 mA, I <sub>F</sub> = 50 mA	4N25M, 4N26M, 4N27M, 4N28M			0.5	V
		I <sub>C</sub> = 0.5 mA, I <sub>F</sub> = 10 mA	4N35M, 4N36M, 4N37M			0.3	V
<b>AC CHARACTERISTICS</b>							
T <sub>ON</sub>	Non-Saturated Turn-on Time	I <sub>F</sub> = 10 mA, V <sub>CC</sub> = 10 V, R <sub>L</sub> = 100 Ω (Figure 13)	4N25M, 4N26M, 4N27M, 4N28M		2		μs
		I <sub>C</sub> = 2 mA, V <sub>CC</sub> = 10 V, R <sub>L</sub> = 100 Ω (Figure 13)	4N35M, 4N36M, 4N37M		2	10	μs
T <sub>OFF</sub>	Turn-off Time	I <sub>F</sub> = 10 mA, V <sub>CC</sub> = 10 V, R <sub>L</sub> = 100 Ω (Figure 13)	4N25M, 4N26M, 4N27M, 4N28M		2		μs
		I <sub>C</sub> = 2 mA, V <sub>CC</sub> = 10 V, R <sub>L</sub> = 100 Ω (Figure 13)	4N35M, 4N36M, 4N37M		2	10	μs

### Isolation Characteristics

Symbol	Characteristic	Test Conditions	Min.	Typ.	Max.	Unit
V <sub>ISO</sub>	Input-Output Isolation Voltage	t = 1 Minute	4170			V <sub>AC RMS</sub>
C <sub>ISO</sub>	Isolation Capacitance	V <sub>I-O</sub> = 0 V, f = 1 MHz		0.2		pF
R <sub>ISO</sub>	Isolation Resistance	V <sub>I-O</sub> = ±500 VDC, T <sub>A</sub> = 25°C	10 <sup>11</sup>			Ω

### Typical Performance Curves

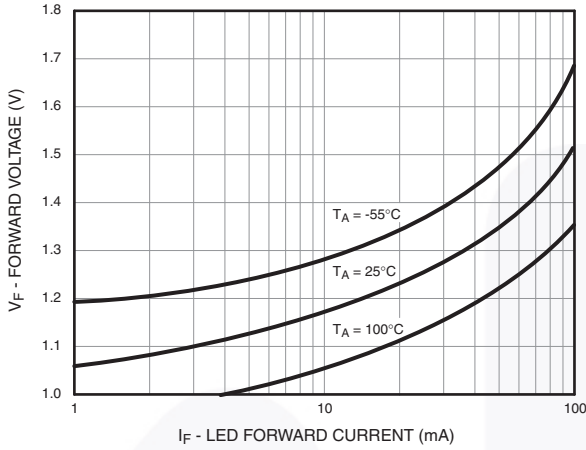

**Figure 3. LED Forward Voltage vs. Forward Current**

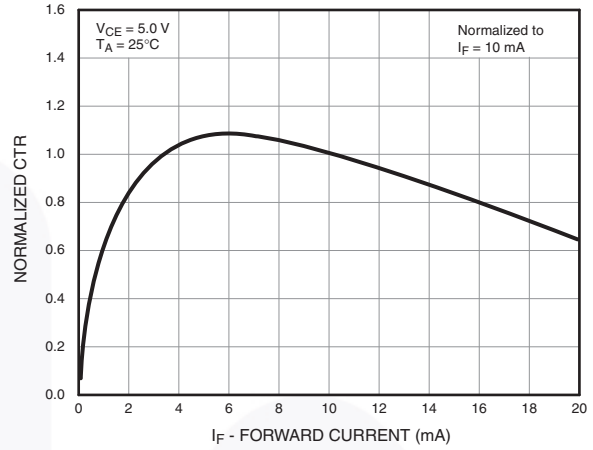

**Figure 4. Normalized CTR vs. Forward Current**

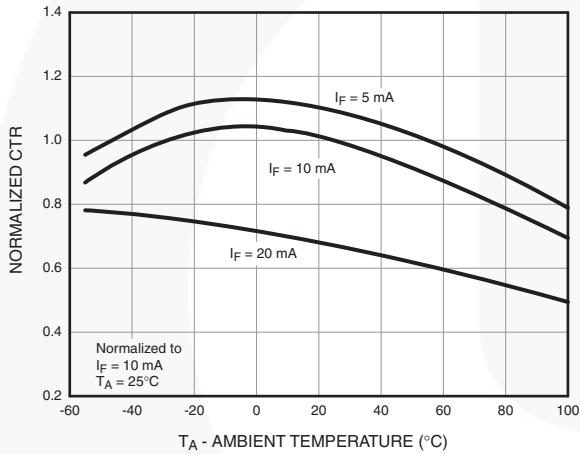

**Figure 5. Normalized CTR vs. Ambient Temperature**

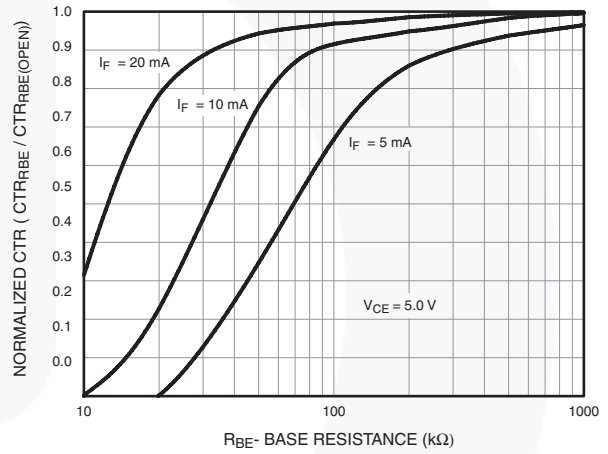

**Figure 6. CTR vs. R<sub>BE</sub> (Unsaturated)**

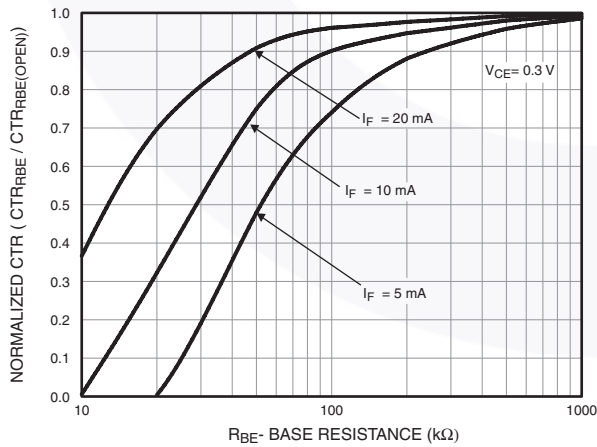

**Figure 7. CTR vs. R<sub>BE</sub> (Saturated)**

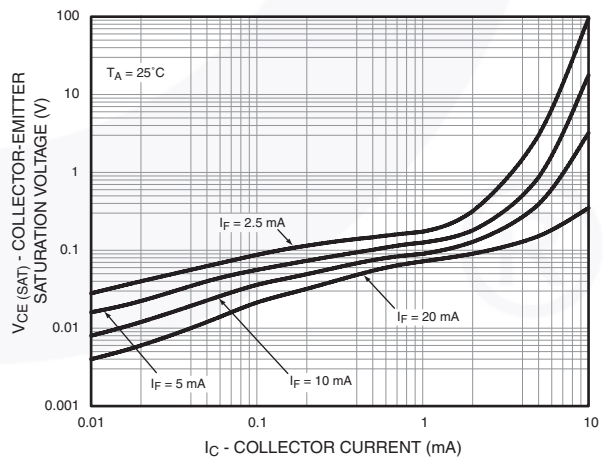

**Figure 8. Collector-Emitter Saturation Voltage vs. Collector Current**

### Typical Performance Curves (Continued)

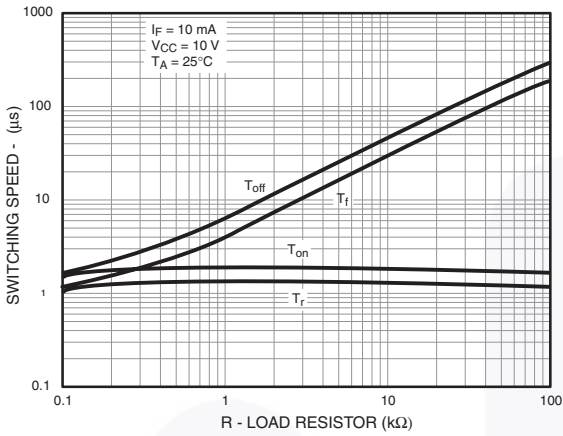

Figure 9. Switching Speed vs. Load Resistor

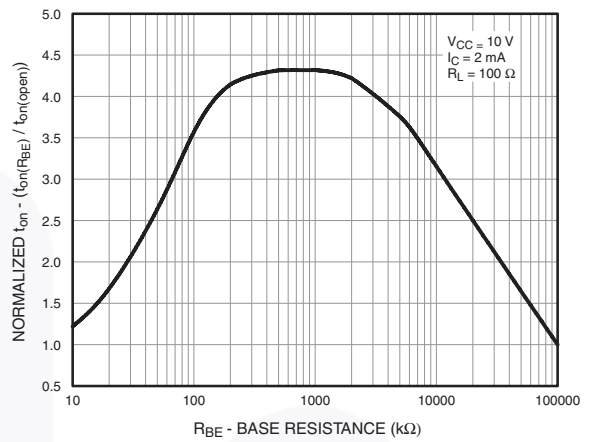

Figure 10. Normalized  $t_{on}$  vs.  $R_{BE}$

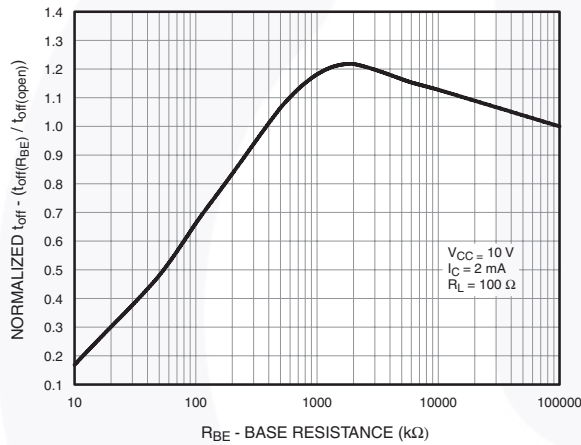

Figure 11. Normalized  $t_{off}$  vs.  $R_{BE}$

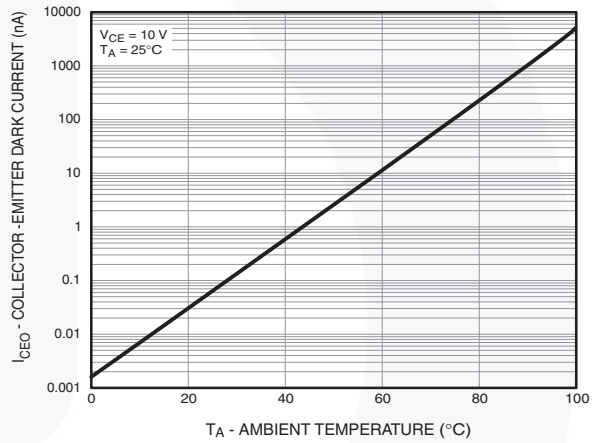

Figure 12. Dark Current vs. Ambient Temperature

### Switching Time Test Circuit and Waveforms

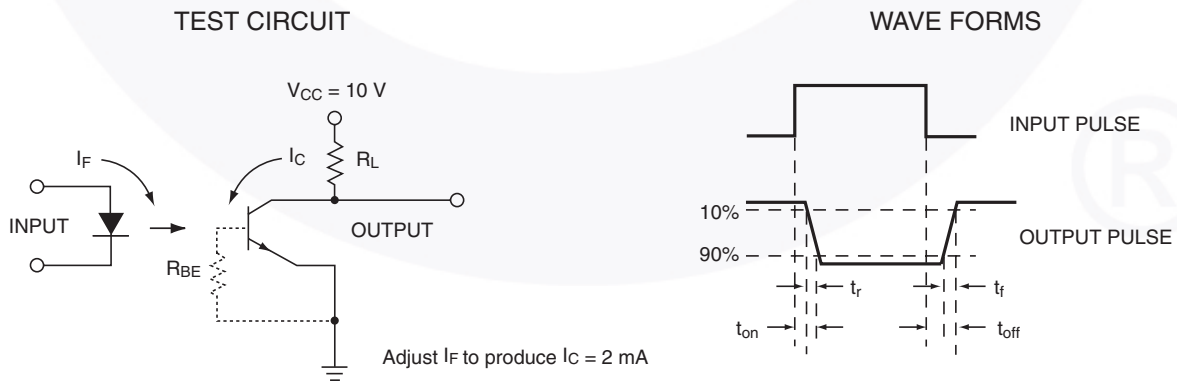

Figure 13. Switching Time Test Circuit and Waveforms

### Reflow Profile

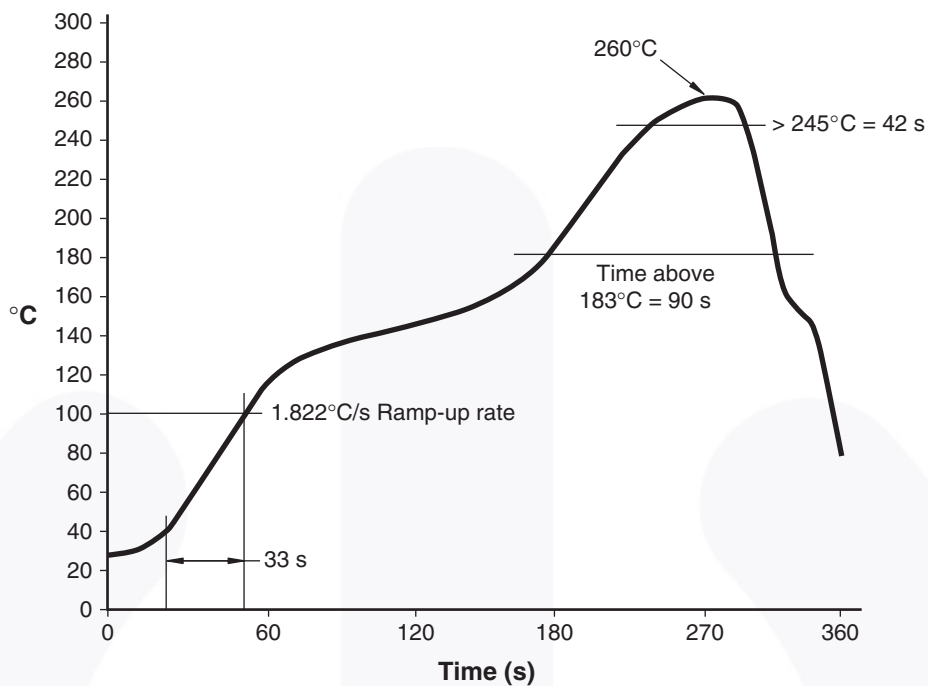

Figure 14. Reflow Profile

## Ordering Information

Part Number	Package	Packing Method
4N25M	DIP 6-Pin	Tube (50 Units)
4N25SM	SMT 6-Pin (Lead Bend)	Tube (50 Units)
4N25SR2M	SMT 6-Pin (Lead Bend)	Tape and Reel (1000 Units)
4N25VM	DIP 6-Pin, DIN EN/IEC60747-5-5 Option	Tube (50 Units)
4N25SVM	SMT 6-Pin (Lead Bend), DIN EN/IEC60747-5-5 Option	Tube (50 Units)
4N25SR2VM	SMT 6-Pin (Lead Bend), DIN EN/IEC60747-5-5 Option	Tape and Reel (1000 Units)
4N25TVM	DIP 6-Pin, 0.4" Lead Spacing, DIN EN/IEC60747-5-5 Option	Tube (50 Units)

### Note:

2. The product orderable part number system listed in this table also applies to the 4N26M, 4N27M, 4N28M, 4N35M, 4N36M, and 4N37M devices.

## Marking Information

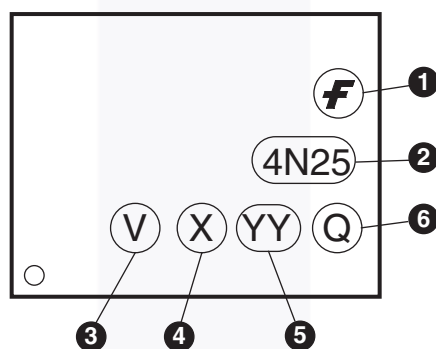

Figure 15. Top Mark

Table 1. Top Mark Definitions

1	Fairchild Logo
2	Device Number
3	DIN EN/IEC60747-5-5 Option (only appears on component ordered with this option)
4	One-Digit Year Code, e.g., "5"
5	Digit Work Week, Ranging from "01" to "53"
6	Assembly Package Code





NOTES:

- A) NO STANDARD APPLIES TO THIS PACKAGE.
- B) ALL DIMENSIONS ARE IN MILLIMETERS.
- C) DIMENSIONS ARE EXCLUSIVE OF BURRS, MOLD FLASH, AND TIE BAR EXTRUSION
- D) DRAWING FILENAME AND REVISION: MKT-N06BREV4.



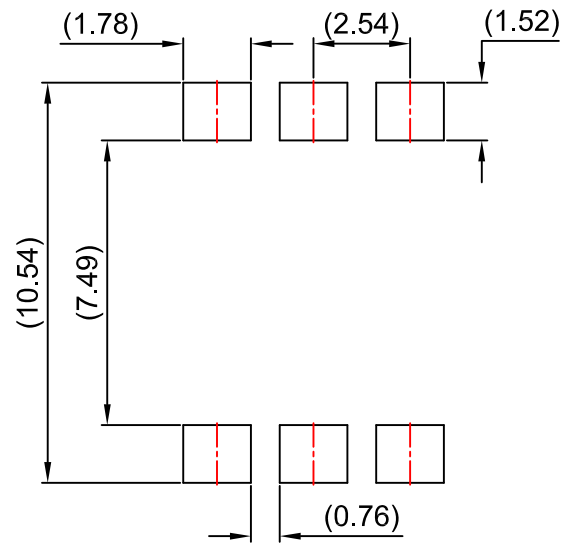
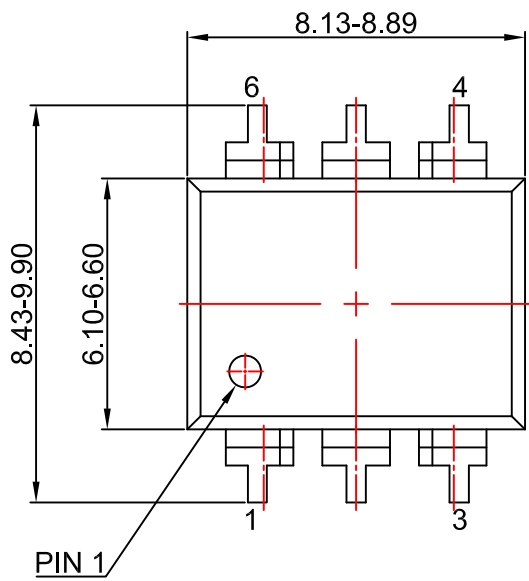

LAND PATTERN RECOMMENDATION



NOTES:

- A) NO STANDARD APPLIES TO THIS PACKAGE.
- B) ALL DIMENSIONS ARE IN MILLIMETERS.
- C) DIMENSIONS ARE EXCLUSIVE OF BURRS, MOLD FLASH, AND TIE BAR EXTRUSION
- D) DRAWING FILENAME AND REVISION : MKT-N06CREV4.





NOTES:

- A) NO STANDARD APPLIES TO THIS PACKAGE.
- B) ALL DIMENSIONS ARE IN MILLIMETERS.
- C) DIMENSIONS ARE EXCLUSIVE OF BURRS, MOLD FLASH, AND TIE BAR EXTRUSION
- D) DRAWING FILENAME AND REVISION: MKT-N06Drev4





**TRADEMARKS**

The following includes registered and unregistered trademarks and service marks, owned by Fairchild Semiconductor and/or its global subsidiaries, and is not intended to be an exhaustive list of all such trademarks.

- |                          |  |                                       |                  |
|--------------------------|--|---------------------------------------|------------------|
| AccuPower™               | F-PFS™   | OPTOPLANAR®                           | SYSTEM GENERAL®  |
| AttitudeEngine™          | FRFET®   | Power Supply WebDesigner™             | TinyBoost®       |
| Awinda®                  | Global Power Resource <sup>SM</sup>            | PowerTrench®                          | TinyBuck®        |
| AX-CAP®*                 | GreenBridge™                                   | PowerXS™                              | TinyCalc™        |
| BitSiC™                  | Green FPS™                                     | Programmable Active Droop™            | TinyLogic®       |
| Build it Now™            | Green FPS™ e-Series™                           | QFET®                                 | TINYOPTO™        |
| CorePLUS™                | Gmax™  | QS™                                   | TinyPower™       |
| CorePOWER™               | GTO™   | Quiet Series™                         | TinyPWM™         |
| CROSSVOL™                | IntelliMAX™                                    | RapidConfigure™                       | TinyWire™        |
| CTL™                     | ISOPLANAR™                                     | Saving our world, 1mW/W/kW at a time™ | TranSiC™         |
| Current Transfer Logic™  | Making Small Speakers Sound Louder and Better™ | SignalWise™                           | TriFault Detect™ |
| DEUXPEED®                | MegaBuck™                                      | SmartMax™                             | TRUECURRENT®*    |
| Dual Cool™               | MICROCOUPLER™                                  | SMART START™                          | μSerDes™         |
| EcoSPARK®                | MicroFET™                                      | Solutions for Your Success™           | UHC®             |
| EfficientMax™            | MicroPak™                                      | SPM®                                  | Ultra FRFET™     |
| ESBC™                    | MicroPak2™                                     | STEALTH™                              | UniFET™          |
| F <sup>®</sup>           | MillerDrive™                                   | SuperFET®                             | Vcx™             |
| Fairchild®               | MotionMax™                                     | SuperSOT™-3                           | VisualMax™       |
| Fairchild Semiconductor® | MotionGrid®                                    | SuperSOT™-6                           | VoltagePlus™     |
| FACT Quiet Series™       | MTi®   | SuperSOT™-8                           | XST™             |
| FACT®                    | MTx®   | SupreMOS®                             | Xsens™           |
| FastvCore™               | MVN®   | SyncFET™                              | 仙童®              |
| FETBench™                | mWSaver®                                       | Sync-Lock™                            |                  |
| FPS™                     | OptoHiT™                                       |                                       |                  |
|                          | OPTOLOGIC®                                     |                                       |                  |

\* Trademarks of System General Corporation, used under license by Fairchild Semiconductor.

**DISCLAIMER**

FAIRCHILD SEMICONDUCTOR RESERVES THE RIGHT TO MAKE CHANGES WITHOUT FURTHER NOTICE TO ANY PRODUCTS HEREIN TO IMPROVE RELIABILITY, FUNCTION, OR DESIGN. TO OBTAIN THE LATEST, MOST UP-TO-DATE DATASHEET AND PRODUCT INFORMATION, VISIT OUR WEBSITE AT [HTTP://WWW.FAIRCHILDSEMI.COM](http://www.fairchildsemi.com). FAIRCHILD DOES NOT ASSUME ANY LIABILITY ARISING OUT OF THE APPLICATION OR USE OF ANY PRODUCT OR CIRCUIT DESCRIBED HEREIN; NEITHER DOES IT CONVEY ANY LICENSE UNDER ITS PATENT RIGHTS, NOR THE RIGHTS OF OTHERS. THESE SPECIFICATIONS DO NOT EXPAND THE TERMS OF FAIRCHILD'S WORLDWIDE TERMS AND CONDITIONS, SPECIFICALLY THE WARRANTY THEREIN, WHICH COVERS THESE PRODUCTS.

**AUTHORIZED USE**

Unless otherwise specified in this data sheet, this product is a standard commercial product and is not intended for use in applications that require extraordinary levels of quality and reliability. This product may not be used in the following applications, unless specifically approved in writing by a Fairchild officer: (1) automotive or other transportation, (2) military/aerospace, (3) any safety critical application – including life critical medical equipment – where the failure of the Fairchild product reasonably would be expected to result in personal injury, death or property damage. Customer's use of this product is subject to agreement of this Authorized Use policy. In the event of an unauthorized use of Fairchild's product, Fairchild accepts no liability in the event of product failure. In other respects, this product shall be subject to Fairchild's Worldwide Terms and Conditions of Sale, unless a separate agreement has been signed by both Parties.

**ANTI-COUNTERFEITING POLICY**

Fairchild Semiconductor Corporation's Anti-Counterfeiting Policy. Fairchild's Anti-Counterfeiting Policy is also stated on our external website, [www.fairchildsemi.com](http://www.fairchildsemi.com), under Terms of Use

Counterfeiting of semiconductor parts is a growing problem in the industry. All manufacturers of semiconductor products are experiencing counterfeiting of their parts. Customers who inadvertently purchase counterfeit parts experience many problems such as loss of brand reputation, substandard performance, failed applications, and increased cost of production and manufacturing delays. Fairchild is taking strong measures to protect ourselves and our customers from the proliferation of counterfeit parts. Fairchild strongly encourages customers to purchase Fairchild parts either directly from Fairchild or from Authorized Fairchild Distributors who are listed by country on our web page cited above. Products customers buy either from Fairchild directly or from Authorized Fairchild Distributors are genuine parts, have full traceability, meet Fairchild's quality standards for handling and storage and provide access to Fairchild's full range of up-to-date technical and product information. Fairchild and our Authorized Distributors will stand behind all warranties and will appropriately address any warranty issues that may arise. Fairchild will not provide any warranty coverage or other assistance for parts bought from Unauthorized Sources. Fairchild is committed to combat this global problem and encourage our customers to do their part in stopping this practice by buying direct or from authorized distributors.

**PRODUCT STATUS DEFINITIONS**

**Definition of Terms**

Datasheet Identification	Product Status	Definition
Advance Information	Formative / In Design	Datasheet contains the design specifications for product development. Specifications may change in any manner without notice.
Preliminary	First Production	Datasheet contains preliminary data; supplementary data will be published at a later date. Fairchild Semiconductor reserves the right to make changes at any time without notice to improve design.
No Identification Needed	Full Production	Datasheet contains final specifications. Fairchild Semiconductor reserves the right to make changes at any time without notice to improve the design.
Obsolete	Not In Production	Datasheet contains specifications on a product that is discontinued by Fairchild Semiconductor. The datasheet is for reference information only.

Rev. I77

# Mouser Electronics

Authorized Distributor

Click to View Pricing, Inventory, Delivery & Lifecycle Information:

[Fairchild Semiconductor:](#)

[4N28SR2M](#) [4N28SVM](#) [4N28TVM](#) [4N28SM](#) [4N28M](#) [4N28SR2VM](#) [4N28VM](#)