



Is Now Part of



ON Semiconductor®

To learn more about ON Semiconductor, please visit our website at
www.onsemi.com

ON Semiconductor and the ON Semiconductor logo are trademarks of Semiconductor Components Industries, LLC dba ON Semiconductor or its subsidiaries in the United States and/or other countries. ON Semiconductor owns the rights to a number of patents, trademarks, copyrights, trade secrets, and other intellectual property. A listing of ON Semiconductor's product/patent coverage may be accessed at www.onsemi.com/site/pdf/Patent-Marking.pdf. ON Semiconductor reserves the right to make changes without further notice to any products herein. ON Semiconductor makes no warranty, representation or guarantee regarding the suitability of its products for any particular purpose, nor does ON Semiconductor assume any liability arising out of the application or use of any product or circuit, and specifically disclaims any and all liability, including without limitation special, consequential or incidental damages. Buyer is responsible for its products and applications using ON Semiconductor products, including compliance with all laws, regulations and safety requirements or standards, regardless of any support or applications information provided by ON Semiconductor. "Typical" parameters which may be provided in ON Semiconductor data sheets and/or specifications can and do vary in different applications and actual performance may vary over time. All operating parameters, including "Typicals" must be validated for each customer application by customer's technical experts. ON Semiconductor does not convey any license under its patent rights nor the rights of others. ON Semiconductor products are not designed, intended, or authorized for use as a critical component in life support systems or any FDA Class 3 medical devices or medical devices with a same or similar classification in a foreign jurisdiction or any devices intended for implantation in the human body. Should Buyer purchase or use ON Semiconductor products for any such unintended or unauthorized application, Buyer shall indemnify and hold ON Semiconductor and its officers, employees, subsidiaries, affiliates, and distributors harmless against all claims, costs, damages, and expenses, and reasonable attorney fees arising out of, directly or indirectly, any claim of personal injury or death associated with such unintended or unauthorized use, even if such claim alleges that ON Semiconductor was negligent regarding the design or manufacture of the part. ON Semiconductor is an Equal Opportunity/Affirmative Action Employer. This literature is subject to all applicable copyright laws and is not for resale in any manner.



September 2015

FAN73611

Single-Channel High-Side Gate Drive IC

Features

- Floating Channel for Bootstrap Operation to +600V
- 250 mA/500 mA Sourcing/Sinking Current Driving Capability
- Common-Mode dv/dt Noise-Canceling Circuit
- 3.3 V and 5 V Input Logic Compatible
- Output In Phase with Input Signal
- Under-Voltage Lockout for V_{DD} and V_{BS}
- 8-Lead Small Outline Package (SOP)

The FAN73611 is a monolithic high-side gate drive IC that can drive MOSFETs and IGBTs operating up to +600 V. Fairchild's high-voltage process and common-mode noise canceling techniques provide stable operation of the high-side driver under high dv/dt noise circumstances. An advanced level-shift circuit offers high-side gate driver operation up to $V_S=-9.8$ V (typical) for $V_{BS}=15$ V. The UVLO circuits prevents malfunction when V_{DD} or V_{BS} is lower than the specified threshold voltage. The output drivers typically source/sink 250 mA/500 mA; respectively, which is suitable for Plasma Display Panel (PDP) application, motor drive inverter, and switching mode power supply applications.

Applications

- Electronic Ballast
- Switching-Mode Power Supply (SMPS)

8-SOP



Related Application Notes

- [AN-6076 — Design and Application Guide of Bootstrap Circuit for High-Voltage Gate-Drive IC](#)
- [AN-9052 — Design Guide for Selection of Bootstrap Components](#)
- [AN-8102 — Recommendations to Avoid Short Pulse Width Issues in HVIC Gate Driver Applications](#)

Description

Ordering Information

Part Number	Package	Operating Temperature	Packing Method	Description
FAN73611MX ⁽¹⁾	8 SOP	-40°C ~ 125°C	Tape & Reel	Lighting Application

Note:

1. This device passed wave soldering test by JESD22A-111.

Typical Application Diagrams

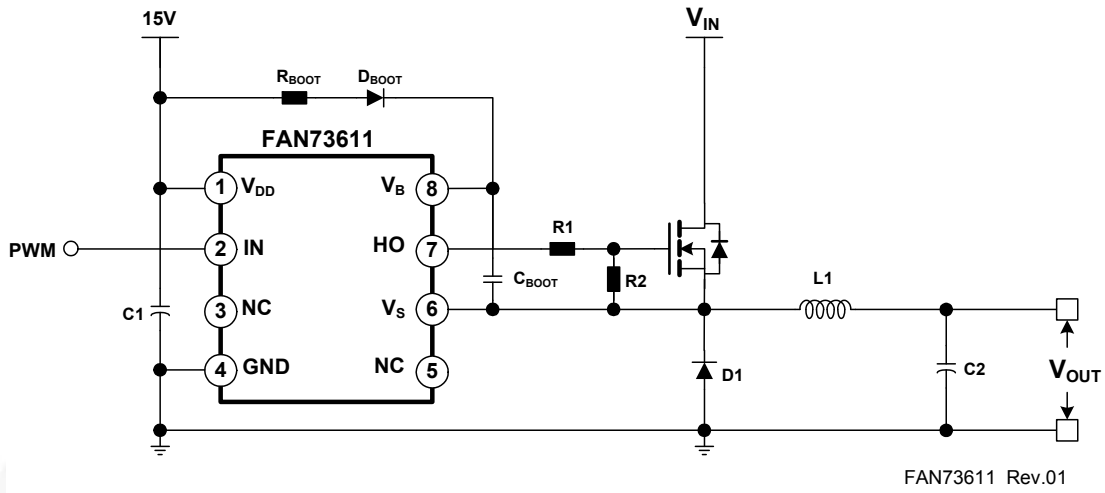

Figure 1. Step-Down (Buck) DC-DC Converter Application

Internal Block Diagram

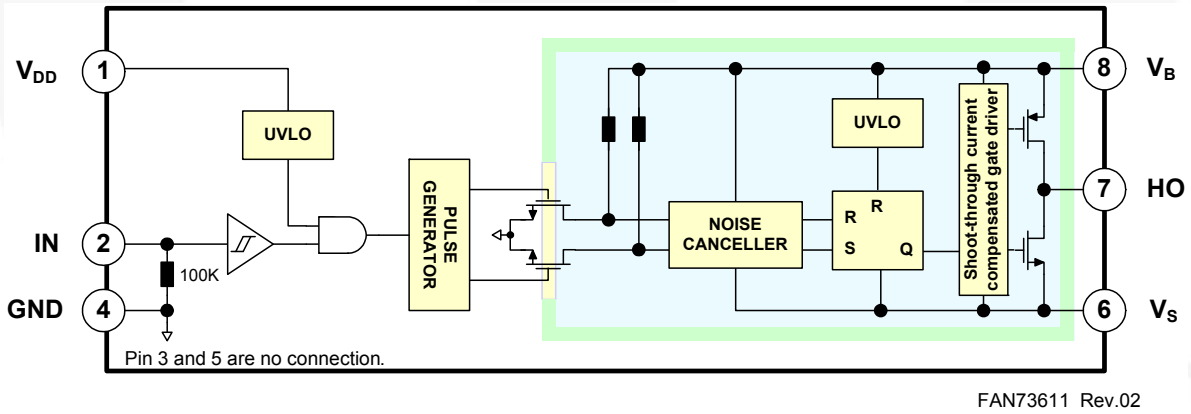

Figure 2. Functional Block Diagram

Pin Configuration

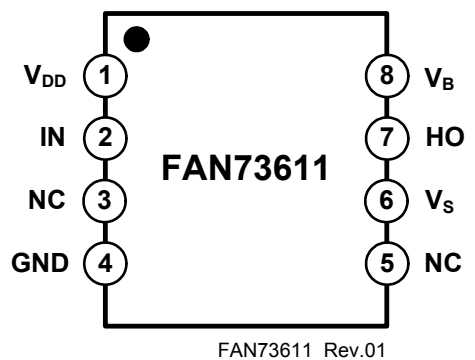

Figure 3. Pin Configuration (Top View)

Pin Definitions

Pin #	Name	Description
1	V _{DD}	Supply Voltage
2	IN	Logic Input for High-Side Gate Driver Output
3	NC	No Connection
4	GND	Ground
5	NC	No Connection
6	V _S	High-Voltage Floating Supply Return
7	HO	High-Side Driver Output
8	V _B	High-Side Floating Supply

Absolute Maximum Ratings

Stresses exceeding the absolute maximum ratings may damage the device. The device may not function or be operable above the recommended operating conditions and stressing the parts to these levels is not recommended. In addition, extended exposure to stresses above the recommended operating conditions may affect device reliability. The absolute maximum ratings are stress ratings only. $T_A=25^{\circ}\text{C}$ unless otherwise specified.

Symbol	Characteristics	Min.	Max.	Unit
V_S	High-Side Floating Offset Voltage	V_B-25	$V_B+0.3$	V
V_B	High-Side Floating Supply Voltage	-0.3	625.0	V
V_{HO}	High-Side Floating Output Voltage	$V_S-0.3$	$V_B+0.3$	V
V_{DD}	Low-Side and Logic Supply Voltage	-0.3	25.0	V
V_{IN}	Logic Input Voltage	-0.3	$V_{DD}+0.3$	V
dV_S/dt	Allowable Offset Voltage Slew Rate		± 50	V/ns
P_D	Power Dissipation ^(2, 3, 4)		0.625	W
θ_{JA}	Thermal Resistance		200	$^{\circ}\text{C}/\text{W}$
T_J	Junction Temperature	-55	+150	$^{\circ}\text{C}$
T_{STG}	Storage Temperature	-55	+150	$^{\circ}\text{C}$

Notes:

- Mounted on 76.2 x 114.3 x 1.6 mm PCB (FR-4 glass epoxy material).
- Refer to the following standards:
JESD51-2: Integrated circuits thermal test method environmental conditions, natural convection, and
JESD51-3: Low effective thermal conductivity test board for leaded surface mount packages.
- Do not exceed power dissipation (P_D) under any circumstances.

Recommended Operating Conditions

The Recommended Operating Conditions table defines the conditions for actual device operation. Recommended operating conditions are specified to ensure optimal performance to the datasheet specifications. Fairchild does not recommend exceeding them or designing to absolute maximum ratings.

Symbol	Parameter	Min.	Max.	Unit
V_B	High-Side Floating Supply Voltage	V_S+10	V_S+20	V
V_S	High-Side Floating Supply Offset Voltage	$6-V_{DD}$	600	V
V_{HO}	High-Side Output Voltage	V_S	V_B	V
V_{IN}	Logic Input Voltage	GND	V_{DD}	V
V_{DD}	Supply Voltage	10	20	V
T_A	Operating Ambient Temperature	-40	+125	$^{\circ}\text{C}$

Electrical Characteristics

$V_{BIAS}(V_{DD}, V_{BS}) = 15.0\text{ V}$ and $T_A = 25^\circ\text{C}$ unless otherwise specified. The V_{IN} and I_{IN} parameters are referenced to GND. The V_O and I_O parameters are relative to V_S and are applicable to the respective output HO.

Symbol	Characteristics	Test Condition	Min.	Typ.	Max.	Unit
Power Supply Section						
I_{QDD}	Quiescent V_{DD} Supply Current	$V_{IN}=0\text{ V}$ or 5 V , $C_{LOAD}=1000\text{ pF}$		80	140	μA
I_{PDD}	Operating V_{DD} Supply Current	$C_{LOAD}=1000\text{ pF}$, $f_{IN}=20\text{ KHz}$, RMS value		80	160	μA
V_{DDUV+} V_{BSUV+}	V_{DD} and V_{BS} Supply Under-Voltage Positive Going Threshold Voltage	$V_{DD}=\text{Sweep}$, $V_{BS}=\text{Sweep}$	7.8	8.8	9.8	V
V_{DDUV-} V_{BSUV-}	V_{DD} and V_{BS} Supply Under-Voltage Negative Going Threshold Voltage	$V_{DD}=\text{Sweep}$, $V_{BS}=\text{Sweep}$	7.3	8.3	9.3	V
V_{DDHYS} V_{BSHYS}	V_{DD} and V_{BS} Supply Under-Voltage Lockout Hysteresis Voltage	$V_{DD}=\text{Sweep}$, $V_{BS}=\text{Sweep}$		0.5		V
I_{LK}	Offset Supply Leakage Current	$V_B=V_S=600\text{ V}$			10	μA
I_{QBS}	Quiescent V_{BS} Supply Current	$V_{IN}=0\text{ V}$ or 5 V , $C_{LOAD}=1000\text{ pF}$		60	100	μA
I_{PBS}	Operating V_{BS} Supply Current	$C_{LOAD}=1000\text{ pF}$, $f_{IN}=20\text{ KHz}$, RMS Value		420	600	μA
Input Logic Section						
V_{IH}	Logic "1" Input Voltage		2.5			V
V_{IL}	Logic "0" Input Voltage				0.8	V
I_{IN+}	Logic Input High Bias Current	$V_{IN}=5\text{ V}$		50	75	μA
I_{IN-}	Logic Input Low Bias Current	$V_{IN}=0\text{ V}$			2	μA
R_{IN}	Input Pull-Down Resistance		60	100		$\text{K}\Omega$
Gate Driver Output Section						
V_{OH}	High Level Output Voltage ($V_{BIAS} - V_O$)	No Load			0.1	V
V_{OL}	Low Level Output Voltage	No Load			0.1	V
I_{O+}	Output High, Short-Circuit Pulsed Current	$V_{HO}=0\text{ V}$, $V_{IN}=5\text{ V}$, $PW \leq 10\text{ }\mu\text{s}$	200	250		mA
I_{O-}	Output Low, Short-Circuit Pulsed Current	$V_{HO}=15\text{ V}$, $V_{IN}=0\text{ V}$, $PW \leq 10\text{ }\mu\text{s}$	400	500		mA
V_S	Allowable Negative V_S Pin Voltage for IN Signal Propagation to HO	$V_{BS}=15\text{ V}$		-9.8	-7.0	V

Dynamic Electrical Characteristics

$V_{DD}=V_{BS}=15\text{ V}$, $C_{LOAD}=1000\text{ pF}$, and $T_A=25^\circ\text{C}$, unless otherwise specified.

Symbol	Parameter	Conditions	Min.	Typ.	Max.	Unit
t_{on}	Turn-On Propagation Delay Time	$V_S=0\text{ V}$	70	120	170	ns
t_{off}	Turn-Off Propagation Delay Time	$V_S=0\text{ V}$	70	120	170	ns
t_r	Turn-On Rise Time			70	140	ns
t_f	Turn-Off Fall Time			30	60	ns

Typical Characteristics

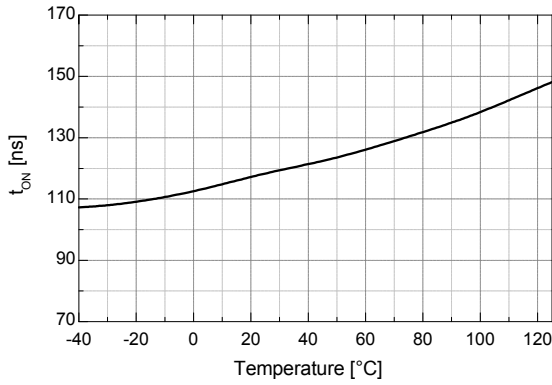

Figure 5. Turn-On Propagation Delay vs. Temperature

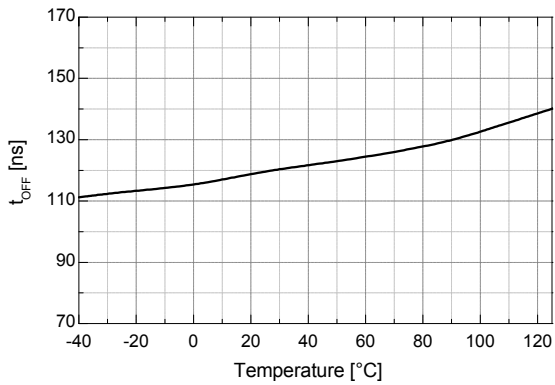

Figure 6. Turn-Off Propagation Delay vs. Temperature

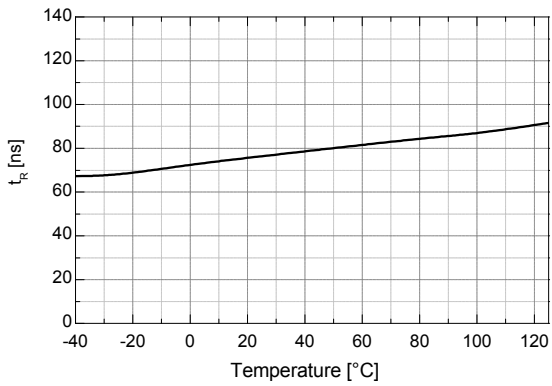

Figure 7. Turn-On Rise Time vs. Temperature

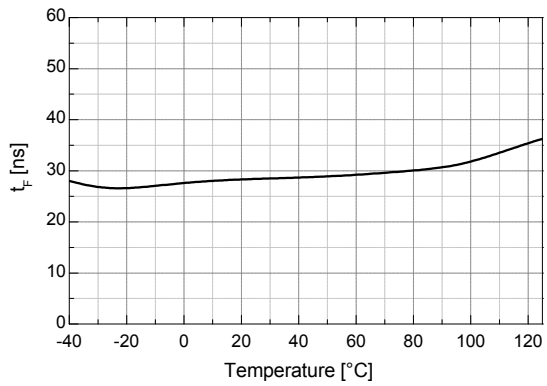

Figure 8. Turn-Off Fall Time vs. Temperature

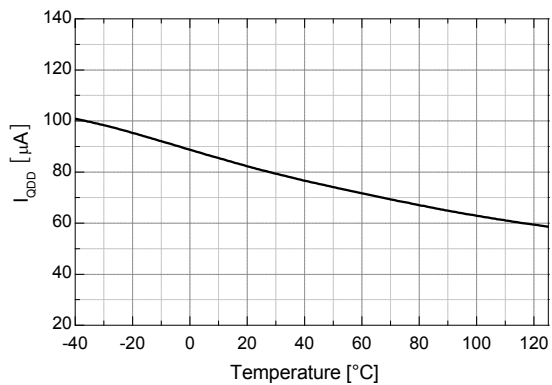

Figure 9. Quiescent V_{DD} Supply Current vs. Temperature

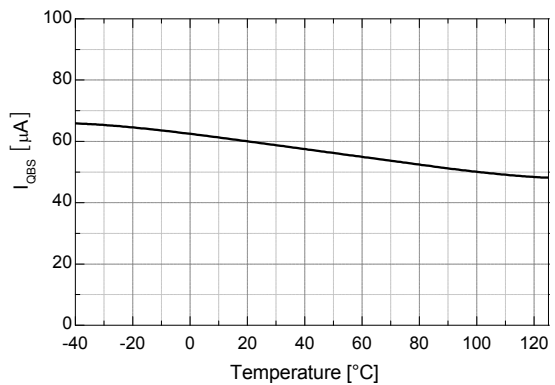

Figure 10. Quiescent V_{BS} Supply Current vs. Temperature

Typical Characteristics (Continued)

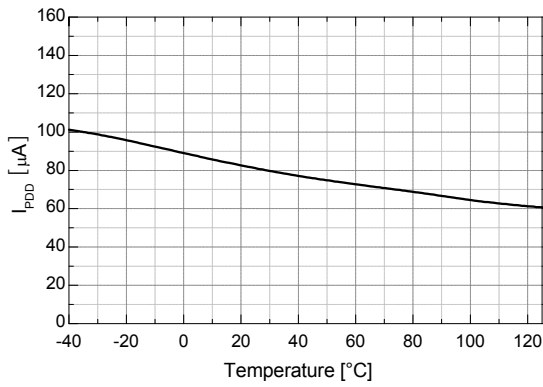

Figure 11. Operating V_{DD} Supply Current vs. Temperature

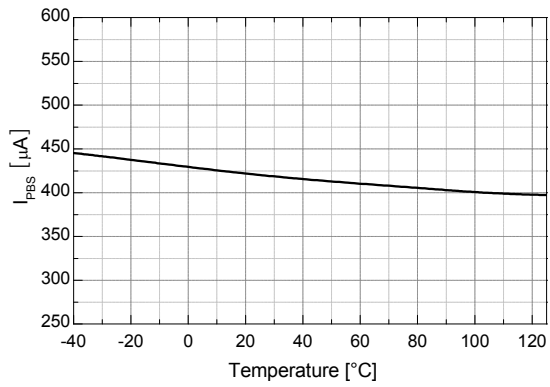

Figure 12. Operating V_{BS} Supply Current vs. Temperature

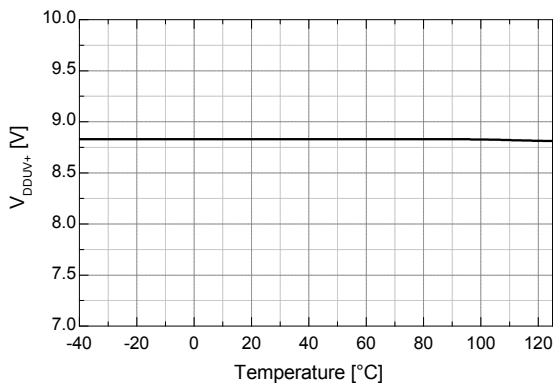

Figure 13. V_{DD} UVLO+ vs. Temperature

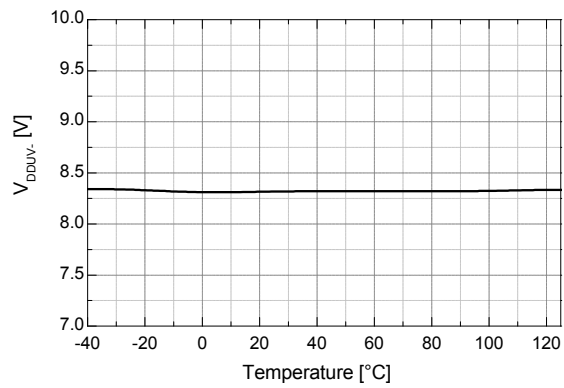

Figure 14. V_{DD} UVLO- vs. Temperature

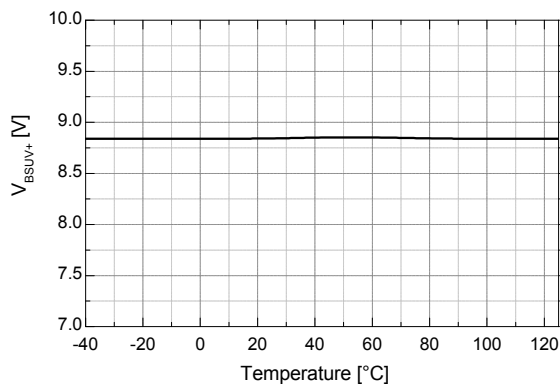

Figure 15. V_{BS} UVLO+ vs. Temperature

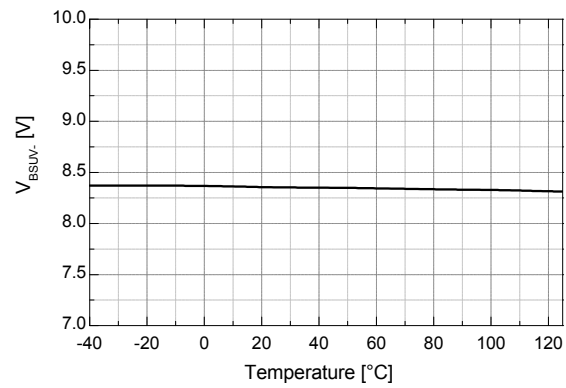

Figure 16. V_{BS} UVLO- vs. Temperature

Typical Characteristics (Continued)

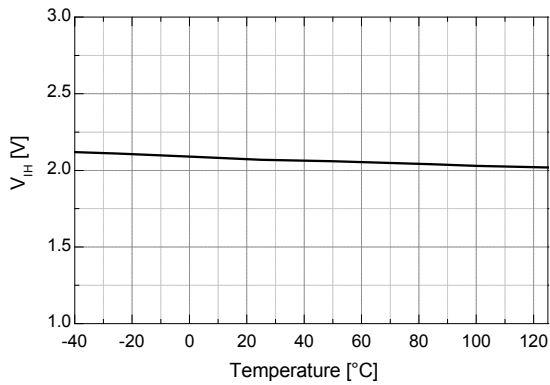

Figure 17. Logic HIGH Input Voltage vs. Temperature

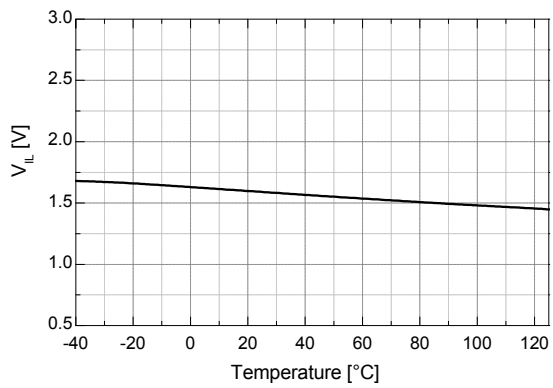

Figure 18. Logic LOW Input Voltage vs. Temperature

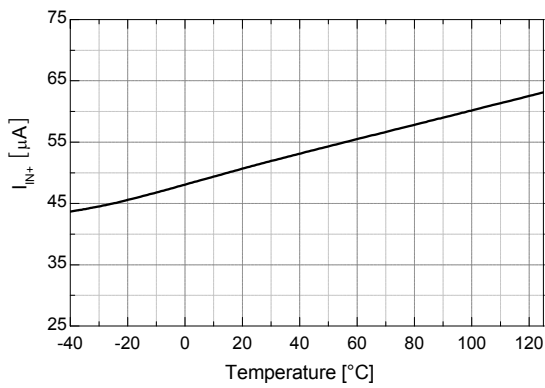

Figure 19. Logic HIGH Input Bias Current vs. Temperature

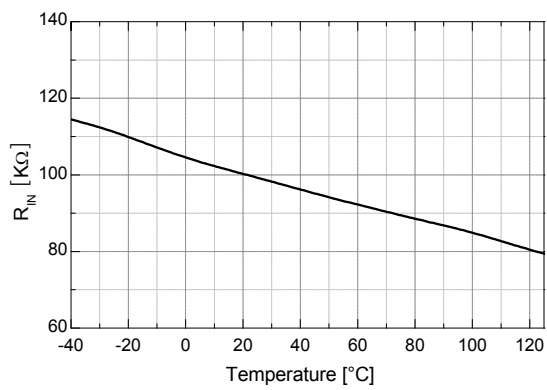

Figure 20. Input Pull-Down Resistance vs. Temperature

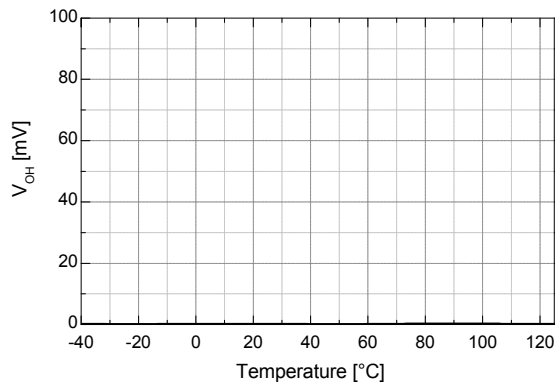

Figure 21. High-Level Output Voltage vs. Temperature

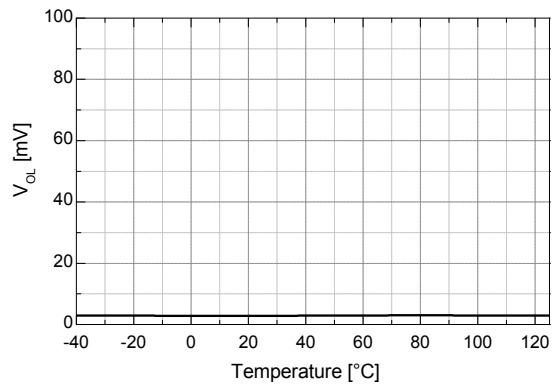

Figure 22. Low-Level Output Voltage vs. Temperature

Typical Characteristics (Continued)

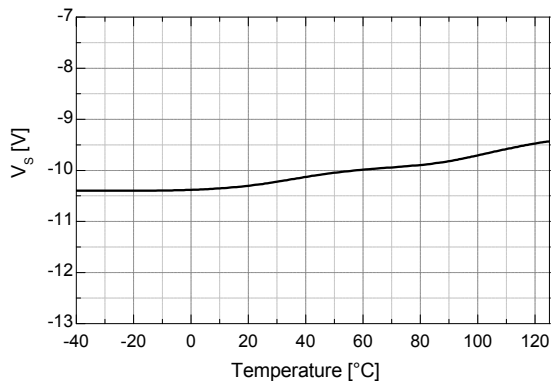

Figure 23. Allowable Negative V_S Voltage vs. Temperature

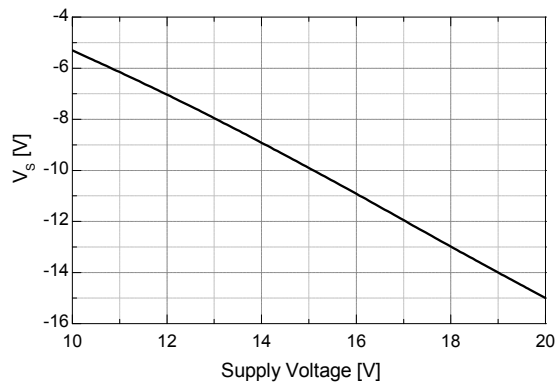

Figure 24. Allowable Negative V_S Voltage vs. Supply Voltage

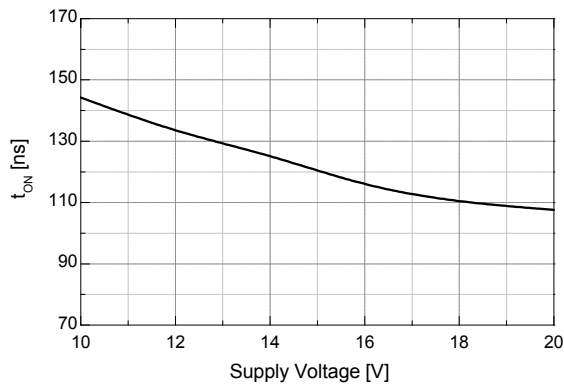

Figure 25. Turn-On Propagation Delay vs. Supply Voltage

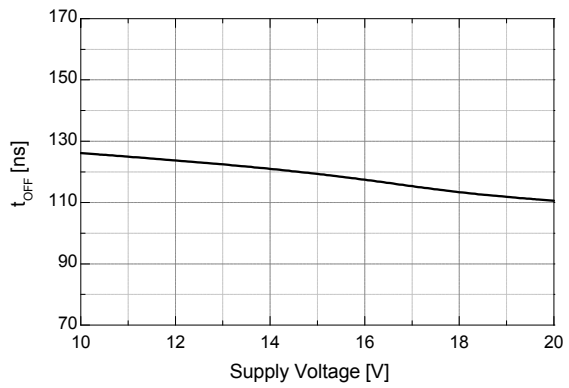

Figure 26. Turn-Off Propagation Delay vs. Supply Voltage

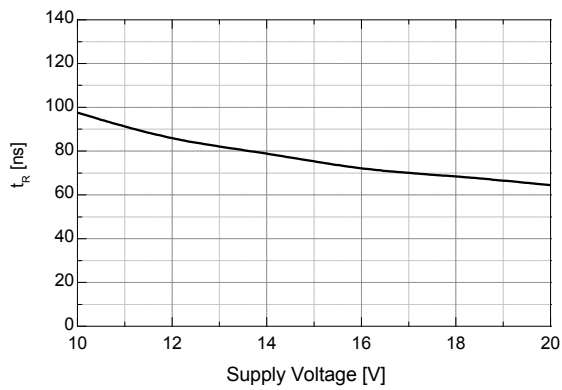

Figure 27. Turn-On Rise Time vs. Supply Voltage

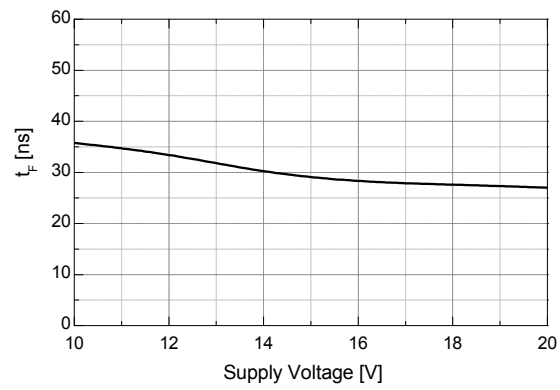

Figure 28. Turn-Off Fall Time vs. Supply Voltage

Typical Characteristics (Continued)

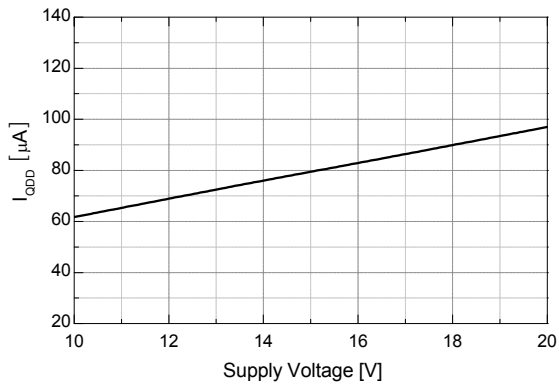

Figure 29. Quiescent V_{DD} Supply Current vs. Supply Voltage

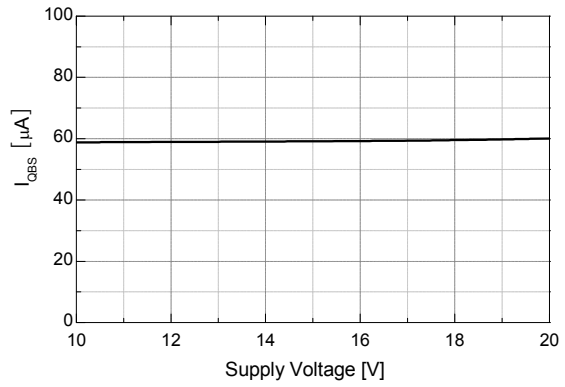

Figure 30. Quiescent V_{BS} Supply Current vs. Supply Voltage

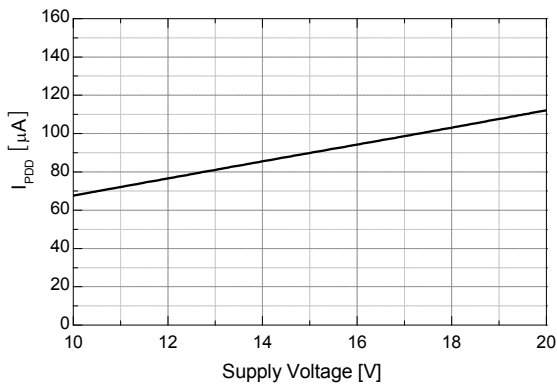

Figure 31. Operating V_{DD} Supply Current vs. Supply Voltage

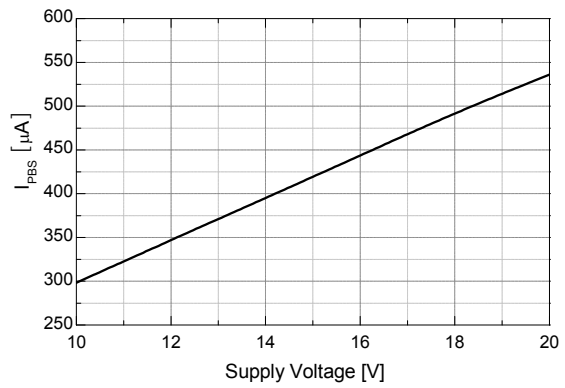

Figure 32. Operating V_{BS} Supply Current vs. Supply Voltage

Switching Time Definitions

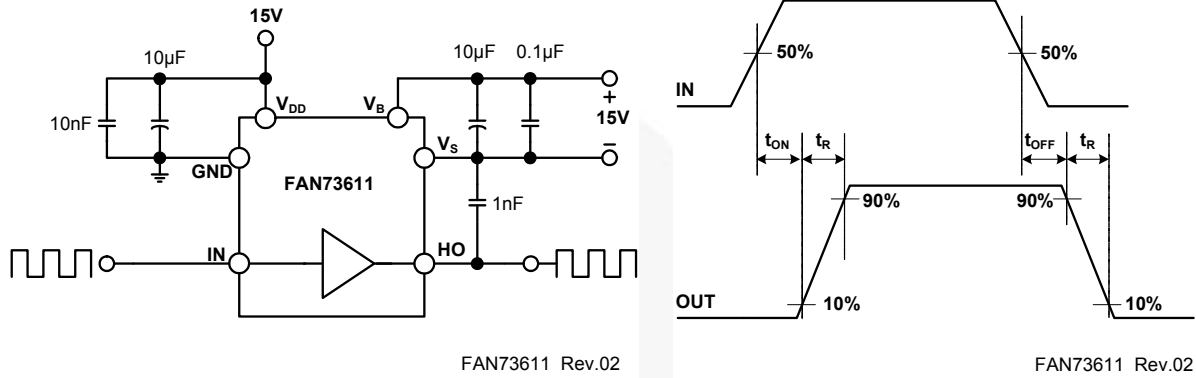

Figure 33. Switching Time Test Circuit and Waveform Definitions

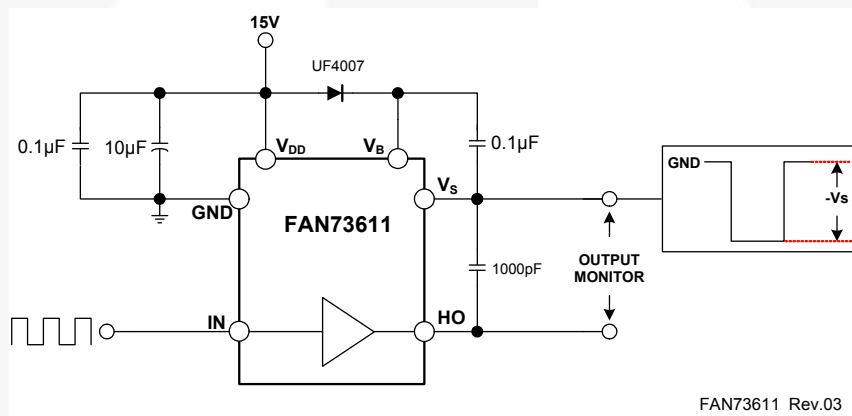

Figure 34. Floating Supply Voltage Transient Test



TOP VIEW



LAND PATTERN RECOMMENDATION



FRONT VIEW



OPTION A
BEVEL EDGE

OPTION B
NON-BEVEL EDGE

SIDE VIEW



DETAIL "B"
SCALE 2:1

NOTES: UNLESS OTHERWISE SPECIFIED

- A. THIS PACKAGE CONFORMS TO JEDEC MS-012 VARIATION A EXCEPT WHERE NOTED.
- B. ALL DIMENSIONS ARE IN MILLIMETERS
- $\triangle C$ OUT OF JEDEC STANDARD VALUE
- D. DIMENSIONS ARE EXCLUSIVE OF BURRS, MOLD FLASH AND TIE BAR EXTRUSIONS.
- E. LAND PATTERN AS PER IPC SOIC127P600X175-8M
- F. DRAWING FILENAME: MKT-M08Brev2





TRADEMARKS

The following includes registered and unregistered trademarks and service marks, owned by Fairchild Semiconductor and/or its global subsidiaries, and is not intended to be an exhaustive list of all such trademarks.

- | | | | |
|--------------------------|--|---------------------------------------|------------------|
| AccuPower™ | F-PFS™ | OPTOPLANAR® | SYSTEM GENERAL® |
| AttitudeEngine™ | FRFET® | Power Supply WebDesigner™ | TinyBoost® |
| Awinda® | Global Power Resource SM | PowerTrench® | TinyBuck® |
| AX-CAP®* | GreenBridge™ | PowerXS™ | TinyCalc™ |
| BitSiC™ | Green FPS™ | Programmable Active Droop™ | TinyLogic® |
| Build it Now™ | Green FPS™ e-Series™ | QFET® | TINYOPTO™ |
| CorePLUS™ | Gmax™ | QS™ | TinyPower™ |
| CorePOWER™ | GTO™ | Quiet Series™ | TinyPWM™ |
| CROSSVOLT™ | IntelliMAX™ | RapidConfigure™ | TinyWire™ |
| CTL™ | ISOPLANAR™ | Saving our world, 1mW/W/kW at a time™ | TranSiC™ |
| Current Transfer Logic™ | Making Small Speakers Sound Louder and Better™ | SignalWise™ | TriFault Detect™ |
| DEUXPEED® | MegaBuck™ | SmartMax™ | TRUECURRENT®* |
| Dual Cool™ | MICROCOUPLER™ | SMART START™ | μSerDes™ |
| EcoSPARK® | MicroFET™ | Solutions for Your Success™ | UHC® |
| EfficientMax™ | MicroPak™ | SPM® | Ultra FRFET™ |
| ESBC™ | MicroPak2™ | STEALTH™ | UniFET™ |
| F [®] | MillerDrive™ | SuperFET® | VCX™ |
| Fairchild® | MotionMax™ | SuperSOT™-3 | VisualMax™ |
| Fairchild Semiconductor® | MotionGrid® | SuperSOT™-6 | VoltagePlus™ |
| FACT Quiet Series™ | MTi® | SuperSOT™-8 | XST™ |
| FACT® | MTx® | SupreMOS® | Xsens™ |
| FastvCore™ | MVN® | SyncFET™ | 仙童® |
| FETBench™ | mWSaver® | Sync-Lock™ | |
| FPS™ | OptoHiT™ | | |
| | OPTOLOGIC® | | |

* Trademarks of System General Corporation, used under license by Fairchild Semiconductor.

DISCLAIMER

FAIRCHILD SEMICONDUCTOR RESERVES THE RIGHT TO MAKE CHANGES WITHOUT FURTHER NOTICE TO ANY PRODUCTS HEREIN TO IMPROVE RELIABILITY, FUNCTION, OR DESIGN. TO OBTAIN THE LATEST, MOST UP-TO-DATE DATASHEET AND PRODUCT INFORMATION, VISIT OUR WEBSITE AT [HTTP://WWW.FAIRCHILDSEMI.COM](http://www.fairchildsemi.com). FAIRCHILD DOES NOT ASSUME ANY LIABILITY ARISING OUT OF THE APPLICATION OR USE OF ANY PRODUCT OR CIRCUIT DESCRIBED HEREIN; NEITHER DOES IT CONVEY ANY LICENSE UNDER ITS PATENT RIGHTS, NOR THE RIGHTS OF OTHERS. THESE SPECIFICATIONS DO NOT EXPAND THE TERMS OF FAIRCHILD'S WORLDWIDE TERMS AND CONDITIONS, SPECIFICALLY THE WARRANTY THEREIN, WHICH COVERS THESE PRODUCTS.

AUTHORIZED USE

Unless otherwise specified in this data sheet, this product is a standard commercial product and is not intended for use in applications that require extraordinary levels of quality and reliability. This product may not be used in the following applications, unless specifically approved in writing by a Fairchild officer: (1) automotive or other transportation, (2) military/aerospace, (3) any safety critical application – including life critical medical equipment – where the failure of the Fairchild product reasonably would be expected to result in personal injury, death or property damage. Customer's use of this product is subject to agreement of this Authorized Use policy. In the event of an unauthorized use of Fairchild's product, Fairchild accepts no liability in the event of product failure. In other respects, this product shall be subject to Fairchild's Worldwide Terms and Conditions of Sale, unless a separate agreement has been signed by both Parties.

ANTI-COUNTERFEITING POLICY

Fairchild Semiconductor Corporation's Anti-Counterfeiting Policy. Fairchild's Anti-Counterfeiting Policy is also stated on our external website, www.fairchildsemi.com, under Terms of Use

Counterfeiting of semiconductor parts is a growing problem in the industry. All manufacturers of semiconductor products are experiencing counterfeiting of their parts. Customers who inadvertently purchase counterfeit parts experience many problems such as loss of brand reputation, substandard performance, failed applications, and increased cost of production and manufacturing delays. Fairchild is taking strong measures to protect ourselves and our customers from the proliferation of counterfeit parts. Fairchild strongly encourages customers to purchase Fairchild parts either directly from Fairchild or from Authorized Fairchild Distributors who are listed by country on our web page cited above. Products customers buy either from Fairchild directly or from Authorized Fairchild Distributors are genuine parts, have full traceability, meet Fairchild's quality standards for handling and storage and provide access to Fairchild's full range of up-to-date technical and product information. Fairchild and our Authorized Distributors will stand behind all warranties and will appropriately address any warranty issues that may arise. Fairchild will not provide any warranty coverage or other assistance for parts bought from Unauthorized Sources. Fairchild is committed to combat this global problem and encourage our customers to do their part in stopping this practice by buying direct or from authorized distributors.

PRODUCT STATUS DEFINITIONS

Definition of Terms

Datasheet Identification	Product Status	Definition
Advance Information	Formative / In Design	Datasheet contains the design specifications for product development. Specifications may change in any manner without notice.
Preliminary	First Production	Datasheet contains preliminary data; supplementary data will be published at a later date. Fairchild Semiconductor reserves the right to make changes at any time without notice to improve design.
No Identification Needed	Full Production	Datasheet contains final specifications. Fairchild Semiconductor reserves the right to make changes at any time without notice to improve the design.
Obsolete	Not In Production	Datasheet contains specifications on a product that is discontinued by Fairchild Semiconductor. The datasheet is for reference information only.

Rev. I77

Mouser Electronics

Authorized Distributor

Click to View Pricing, Inventory, Delivery & Lifecycle Information:

[Fairchild Semiconductor:](#)

[FAN73611M](#) [FAN73611MX](#)