



Is Now Part of



**ON Semiconductor®**

To learn more about ON Semiconductor, please visit our website at  
[www.onsemi.com](http://www.onsemi.com)

ON Semiconductor and the ON Semiconductor logo are trademarks of Semiconductor Components Industries, LLC dba ON Semiconductor or its subsidiaries in the United States and/or other countries. ON Semiconductor owns the rights to a number of patents, trademarks, copyrights, trade secrets, and other intellectual property. A listing of ON Semiconductor's product/patent coverage may be accessed at [www.onsemi.com/site/pdf/Patent-Marking.pdf](http://www.onsemi.com/site/pdf/Patent-Marking.pdf). ON Semiconductor reserves the right to make changes without further notice to any products herein. ON Semiconductor makes no warranty, representation or guarantee regarding the suitability of its products for any particular purpose, nor does ON Semiconductor assume any liability arising out of the application or use of any product or circuit, and specifically disclaims any and all liability, including without limitation special, consequential or incidental damages. Buyer is responsible for its products and applications using ON Semiconductor products, including compliance with all laws, regulations and safety requirements or standards, regardless of any support or applications information provided by ON Semiconductor. "Typical" parameters which may be provided in ON Semiconductor data sheets and/or specifications can and do vary in different applications and actual performance may vary over time. All operating parameters, including "Typicals" must be validated for each customer application by customer's technical experts. ON Semiconductor does not convey any license under its patent rights nor the rights of others. ON Semiconductor products are not designed, intended, or authorized for use as a critical component in life support systems or any FDA Class 3 medical devices or medical devices with a same or similar classification in a foreign jurisdiction or any devices intended for implantation in the human body. Should Buyer purchase or use ON Semiconductor products for any such unintended or unauthorized application, Buyer shall indemnify and hold ON Semiconductor and its officers, employees, subsidiaries, affiliates, and distributors harmless against all claims, costs, damages, and expenses, and reasonable attorney fees arising out of, directly or indirectly, any claim of personal injury or death associated with such unintended or unauthorized use, even if such claim alleges that ON Semiconductor was negligent regarding the design or manufacture of the part. ON Semiconductor is an Equal Opportunity/Affirmative Action Employer. This literature is subject to all applicable copyright laws and is not for resale in any manner.



# FDG6342L

## Integrated Load Switch

### Features

- Max  $r_{DS(on)}$  = 150mΩ at  $V_{GS} = 4.5V, I_D = -1.5A$
- Max  $r_{DS(on)}$  = 195mΩ at  $V_{GS} = 2.5V, I_D = -1.3A$
- Max  $r_{DS(on)}$  = 280mΩ at  $V_{GS} = 1.8V, I_D = -1.1A$
- Max  $r_{DS(on)}$  = 480mΩ at  $V_{GS} = 1.5V, I_D = -0.9A$
- Control MOSFET (Q1) includes Zener protection for ESD ruggedness (>4KV Human body model)
- High performance trench technology for extremely low  $r_{DS(on)}$
- Compact industry standard SC70-6 surface mount package
- RoHS Compliant

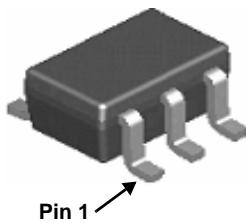


### General Description

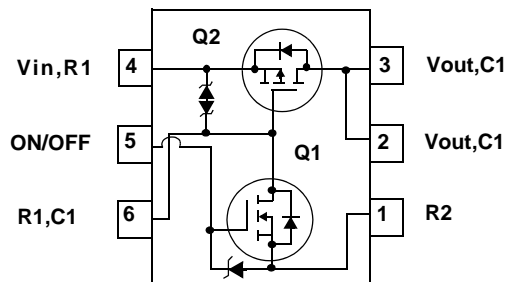
This device is particularly suited for compact power management in portable electronic equipment where 2.5V to 8V input and 1.5A output current capability are needed. This load switch integrates a small N-Channel power MOSFET (Q1) that drives a large P-Channel power MOSFET (Q2) in one tiny SC70-6 package.

### Applications

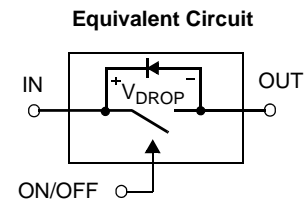
- Power management
- Load switch



SC70-6



See Application Circuit



### MOSFET Maximum Ratings $T_A = 25^\circ C$ unless otherwise noted

Symbol	Parameter	Ratings	Units
$V_{IN}$	Gate to Source Voltage (Q2)	±8	V
$V_{ON/OFF}$	Gate to Source Voltage (Q1)	-0.5 to 8	V
$I_{Load}$	Load Current -Continuous	(Note 2) 1.5	A
	-Pulsed	(Note 2) 6	
$P_D$	Power Dissipation for Single Operation	(Note 1a) 0.36	W
		(Note 1b) 0.3	
$T_J, T_{STG}$	Operating and Storage Junction Temperature Range	-55 to +150	°C

### Thermal Characteristics

$R_{\theta JA}$	Thermal Resistance, Junction to Ambient Single operation	(Note 1a) 350	°C/W
$R_{\theta JA}$	Thermal Resistance, Junction to Ambient Single operation	(Note 1b) 415	

### Package Marking and Ordering Information

Device Marking	Device	Package	Reel Size	Tape Width	Quantity
.2L	FDG6342L	SC70-6	7"	8mm	3000units

## Electrical Characteristics $T_J = 25^\circ\text{C}$ unless otherwise noted

Symbol	Parameter	Test Conditions	Min	Typ	Max	Units
--------	-----------	-----------------	-----	-----	-----	-------

### Off Characteristics

$BV_{IN}$	$V_{IN}$ Breakdown Voltage	$I_D = -250\mu\text{A}$ , $V_{ON/OFF} = 0\text{V}$	8			V
$I_{Load}$	Zero Gate Voltage Drain Current	$V_{IN} = -6.4\text{V}$ , $V_{ON/OFF} = 0\text{V}$			-1	$\mu\text{A}$
$I_{FL}$	Leakage Current, Forward	$V_{IN} = 8\text{V}$ , $V_{ON/OFF} = 0\text{V}$			10	$\mu\text{A}$
$I_{RL}$	Leakage Current, Reverse	$V_{IN} = -8\text{V}$ , $V_{ON/OFF} = 0\text{V}$			-10	$\mu\text{A}$

### On Characteristics (note 2)

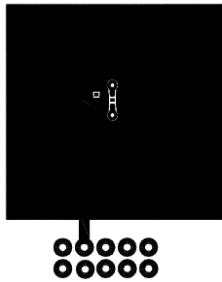
$V_{ON/OFF(th)}$	Gate Threshold Voltage	$V_{IN} = V_{ON/OFF}$ , $I_D = -250\mu\text{A}$	0.65	0.8	1.5	V
$r_{DS(on)}$	Static Drain to Source On Resistance (Q2)	$V_{IN} = 4.5\text{V}$ , $I_D = -1.5\text{A}$		125	150	$\text{m}\Omega$
		$V_{IN} = 2.5\text{V}$ , $I_D = -1.3\text{A}$		150	195	
		$V_{IN} = 1.8\text{V}$ , $I_D = -1.1\text{A}$		200	280	
		$V_{IN} = 1.5\text{V}$ , $I_D = -0.9\text{A}$		250	480	
	Static Drain to Source On Resistance (Q1)	$V_{IN} = 4.5\text{V}$ , $I_D = 0.4\text{A}$	2.6	4.0	$\Omega$	
	$V_{IN} = 2.7\text{V}$ , $I_D = 0.2\text{A}$	3.3	5.0			

### Drain-Source Diode Characteristics

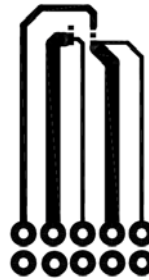
$I_S$	Maximum Continuous Drain to Source Diode Forward Current			-0.25	A	
$V_{SD}$	Source to Drain Diode Forward Voltage	$V_{ON/OFF} = 0\text{V}$ , $I_S = -0.25\text{A}$ (Note 2)		-0.6	-1.2	V

#### NOTES:

- $R_{\theta JA}$  is determined with the device mounted on a 1 in<sup>2</sup> pad 2 oz copper pad on a 1.5 x 1.5 in. board of FR-4 material.  $R_{\theta JC}$  is guaranteed by design while  $R_{\theta JA}$  is determined by the user's board design.



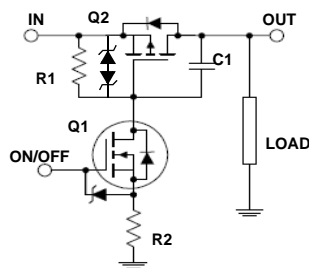
a. 350°C/W when mounted on a 1 in<sup>2</sup> pad of 2 oz copper.



b. 415°C/W when mounted on a minimum pad of 2 oz copper.

- Pulse Test: Pulse Width < 300 $\mu\text{s}$ , Duty cycle < 2.0%.

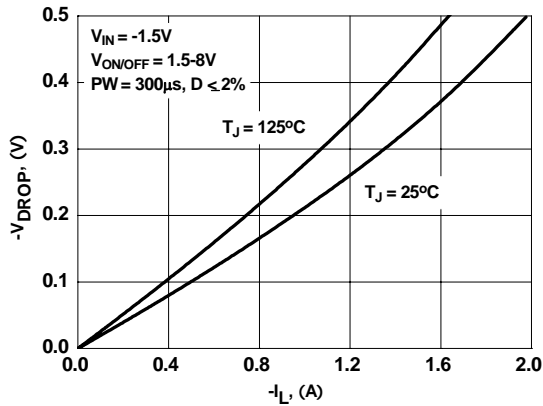
### FDG6342L Load Switch Application circuit



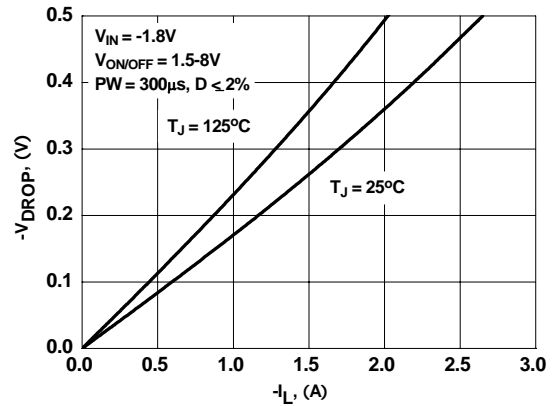
#### External Component Recommendation:

For additional in-rush current control, R2 and C1 can be added. For more information, see application note AN1030

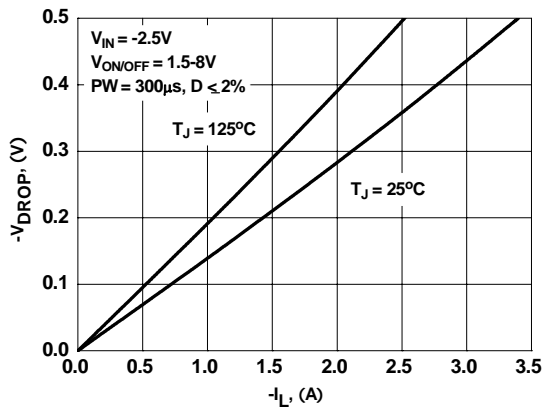
**Typical Characteristics**  $T_J = 25^\circ\text{C}$  unless otherwise noted



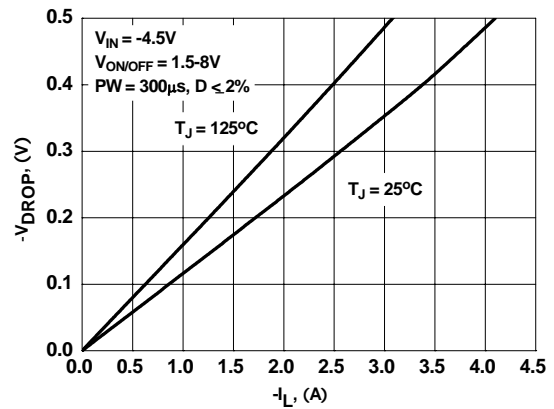
**Figure 1. Conduction Voltage Drop Variation with Load Current.**



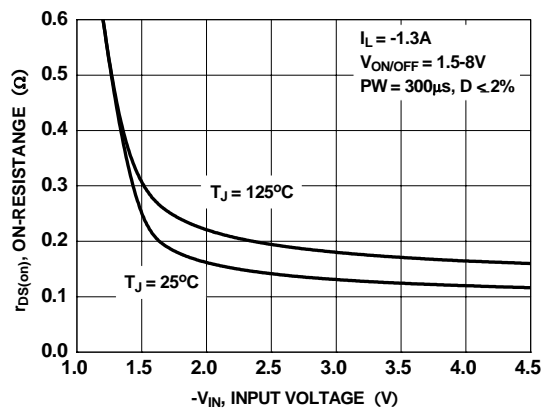
**Figure 2. Conduction Voltage Drop Variation with Load Current.**



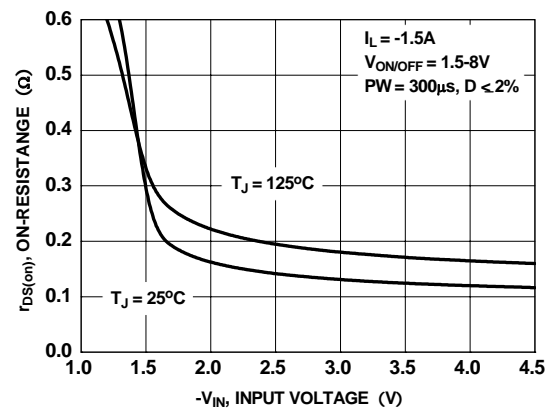
**Figure 3. Conduction Voltage Drop Variation with Load Current.**



**Figure 4. Conduction Voltage Drop Variation with Load Current.**

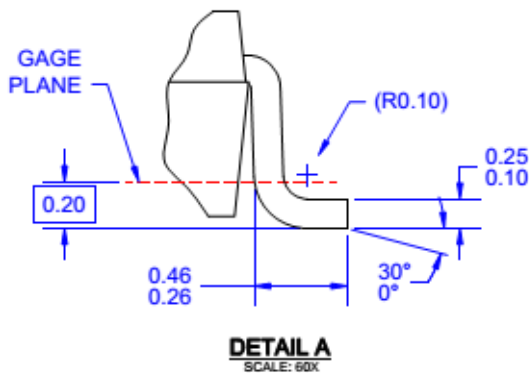
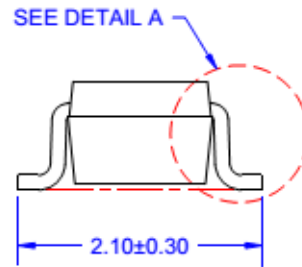
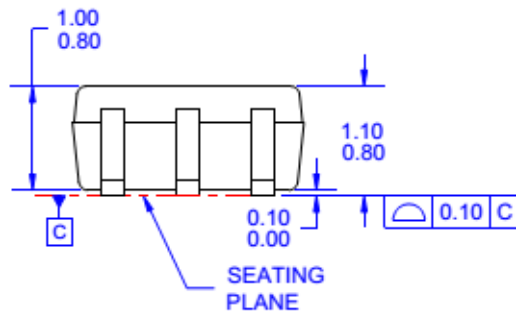
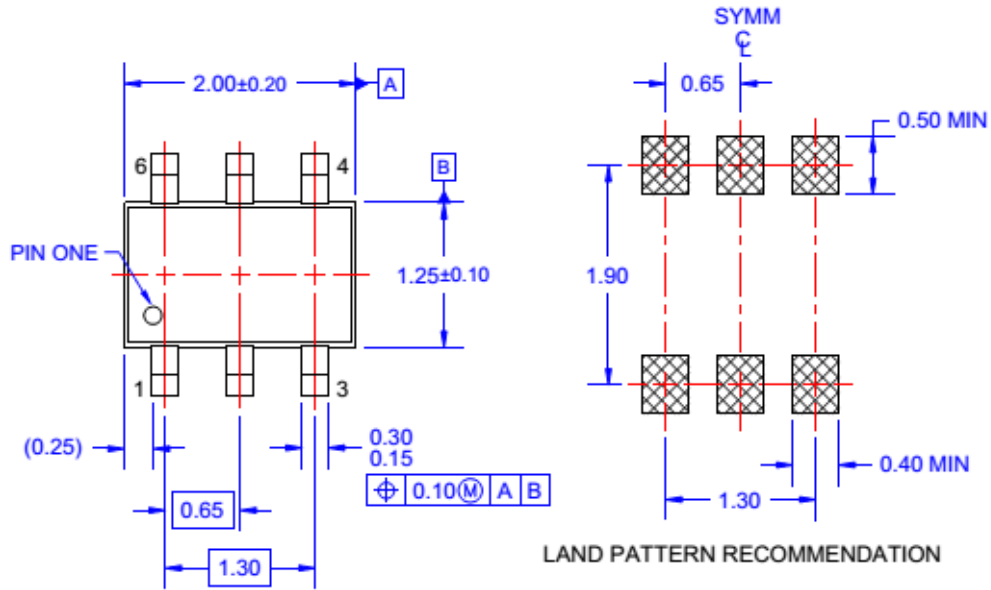


**Figure 5. On-Resistance Variation With Input Voltage**



**Figure 6. On-Resistance Variation With Input Voltage**

## Dimensional Outline and Pad Layout



**NOTES: UNLESS OTHERWISE SPECIFIED**

- A) THIS PACKAGE CONFORMS TO EIAJ SC-88, 1996.
- B) ALL DIMENSIONS ARE IN MILLIMETERS.
- C) DIMENSIONS DO NOT INCLUDE BURRS OR MOLD FLASH.
- D) DRAWING FILENAME: MKT-MAA06AREV6

Package drawings are provided as a service to customers considering Fairchild components. Drawings may change in any manner without notice. Please note the revision and/or date on the drawing and contact a Fairchild Semiconductor representative to verify or obtain the most recent revision. Package specifications do not expand the terms of Fairchild's worldwide terms and conditions, specifically the warranty therein, which covers Fairchild products.

Always visit Fairchild Semiconductor's online packaging area for the most recent package drawings:  
[https://www.fairchildsemi.com/evaluate/package-specifications/packageDetails.html?id=PN\\_NSC70-006](https://www.fairchildsemi.com/evaluate/package-specifications/packageDetails.html?id=PN_NSC70-006)



**TRADEMARKS**

The following includes registered and unregistered trademarks and service marks, owned by Fairchild Semiconductor and/or its global subsidiaries, and is not intended to be an exhaustive list of all such trademarks.

- |                          |   |                                       |                  |
|--------------------------|---|---------------------------------------|------------------|
| AccuPower™               | F-PFET™   | OPTOPLANAR®                           |                  |
| Awinda®                  | FRFET®  |                                       | TinyBoost®       |
| AX-CAP®*                 | Global Power Resource™                          | PowerTrench®                          | TinyBuck®        |
| BitSiC™                  | GreenBridge™                                    | PowerXST™                             | TinyCalc™        |
| Build it Now™            | Green FPS™                                      | Programmable Active Droop™            | TinyLogic®       |
| CorePLUS™                | Green FPS™ e-Series™                            | QFET®                                 | TINYOPTO™        |
| CorePOWER™               | Gmax™   | QS™                                   | TinyPower™       |
| CROSSVOLT™               | GTO™  | Quiet Series™                         | TinyPWM™         |
| CTL™                     | IntelliMAX™                                     | RapidConfigure™                       | TinyWire™        |
| Current Transfer Logic™  | ISOPANAR™                                       |                                       | TranSiC™         |
| DEUXPEED®                | Marking Small Speakers Sound Louder and Better™ | Saving our world, 1mW/W/kW at a time™ | TriFault Detect™ |
| Dual Cool™               | MegaBuck™                                       | SignalWise™                           | TRUECURRENT®*    |
| EcoSPARK®                | MICROCOUPLER™                                   | SmartMax™                             | μSerDes™         |
| EfficientMax™            | MicroFET™                                       | SMART START™                          |                  |
| ESBC™                    | MicroPak™                                       | Solutions for Your Success™           | UHC®             |
|                          | MicroPak2™                                      | SPM®                                  | Ultra FRFET™     |
| Fairchild®               | MillerDrive™                                    | STEALTH™                              | UniFET™          |
| Fairchild Semiconductor® | MotionMax™                                      | SuperFET®                             | VCX™             |
| FACT Quiet Series™       | MotionGrid®                                     | SuperSOT™-3                           | VisualMax™       |
| FACT®                    | MTi®  | SuperSOT™-6                           | VoltagePlus™     |
| FAST®                    | MTx®  | SuperSOT™-8                           | XST™             |
| FastvCore™               | MVN®  | SupreMOS®                             | Xsens™           |
| FETBench™                | mWSaver®  | SyncFET™                              | 仙童™              |
| FPS™                     | OptoHiT™  | Sync-Lock™                            |                  |
|                          | OPTOLOGIC®                                      |                                       |                  |

\*Trademarks of System General Corporation, used under license by Fairchild Semiconductor.

**DISCLAIMER**

FAIRCHILD SEMICONDUCTOR RESERVES THE RIGHT TO MAKE CHANGES WITHOUT FURTHER NOTICE TO ANY PRODUCTS HEREIN TO IMPROVE RELIABILITY, FUNCTION, OR DESIGN. TO OBTAIN THE LATEST, MOST UP-TO-DATE DATASHEET AND PRODUCT INFORMATION, VISIT OUR WEBSITE AT [HTTP://WWW.FAIRCHILDSEMI.COM](http://www.fairchildsemi.com). FAIRCHILD DOES NOT ASSUME ANY LIABILITY ARISING OUT OF THE APPLICATION OR USE OF ANY PRODUCT OR CIRCUIT DESCRIBED HEREIN; NEITHER DOES IT CONVEY ANY LICENSE UNDER ITS PATENT RIGHTS, NOR THE RIGHTS OF OTHERS. THESE SPECIFICATIONS DO NOT EXPAND THE TERMS OF FAIRCHILD'S WORLDWIDE TERMS AND CONDITIONS, SPECIFICALLY THE WARRANTY THEREIN, WHICH COVERS THESE PRODUCTS.

**LIFE SUPPORT POLICY**

FAIRCHILD'S PRODUCTS ARE NOT AUTHORIZED FOR USE AS CRITICAL COMPONENTS IN LIFE SUPPORT DEVICES OR SYSTEMS WITHOUT THE EXPRESS WRITTEN APPROVAL OF FAIRCHILD SEMICONDUCTOR CORPORATION.

As used here in:

- Life support devices or systems are devices or systems which, (a) are intended for surgical implant into the body or (b) support or sustain life, and (c) whose failure to perform when properly used in accordance with instructions for use provided in the labeling, can be reasonably expected to result in a significant injury of the user.
- A critical component in any component of a life support, device, or system whose failure to perform can be reasonably expected to cause the failure of the life support device or system, or to affect its safety or effectiveness.

**ANTI-COUNTERFEITING POLICY**

Fairchild Semiconductor Corporation's Anti-Counterfeiting Policy. Fairchild's Anti-Counterfeiting Policy is also stated on our external website, [www.fairchildsemi.com](http://www.fairchildsemi.com), under Sales Support.

Counterfeiting of semiconductor parts is a growing problem in the industry. All manufactures of semiconductor products are experiencing counterfeiting of their parts. Customers who inadvertently purchase counterfeit parts experience many problems such as loss of brand reputation, substandard performance, failed application, and increased cost of production and manufacturing delays. Fairchild is taking strong measures to protect ourselves and our customers from the proliferation of counterfeit parts. Fairchild strongly encourages customers to purchase Fairchild parts either directly from Fairchild or from Authorized Fairchild Distributors who are listed by country on our web page cited above. Products customers buy either from Fairchild directly or from Authorized Fairchild Distributors are genuine parts, have full traceability, meet Fairchild's quality standards for handling and storage and provide access to Fairchild's full range of up-to-date technical and product information. Fairchild and our Authorized Distributors will stand behind all warranties and will appropriately address and warranty issues that may arise. Fairchild will not provide any warranty coverage or other assistance for parts bought from Unauthorized Sources. Fairchild is committed to combat this global problem and encourage our customers to do their part in stopping this practice by buying direct or from authorized distributors.

**PRODUCT STATUS DEFINITIONS**

**Definition of Terms**

Datasheet Identification	Product Status	Definition
Advance Information	Formative / In Design	Datasheet contains the design specifications for product development. Specifications may change in any manner without notice.
Preliminary	First Production	Datasheet contains preliminary data; supplementary data will be published at a later date. Fairchild Semiconductor reserves the right to make changes at any time without notice to improve design.
No Identification Needed	Full Production	Datasheet contains final specifications. Fairchild Semiconductor reserves the right to make changes at any time without notice to improve the design.
Obsolete	Not In Production	Datasheet contains specifications on a product that is discontinued by Fairchild Semiconductor. The datasheet is for reference information only.

# Mouser Electronics

Authorized Distributor

Click to View Pricing, Inventory, Delivery & Lifecycle Information:

[Fairchild Semiconductor:](#)

[FDG6342L](#)