



FDMA908PZ

Single P-Channel PowerTrench[®] MOSFET

-12 V, -12 A, 12.5 mΩ

Features

- Max $r_{DS(on)}$ = 12.5 mΩ at $V_{GS} = -4.5$ V, $I_D = -12$ A
- Max $r_{DS(on)}$ = 18 mΩ at $V_{GS} = -2.5$ V, $I_D = -10$ A
- Max $r_{DS(on)}$ = 28 mΩ at $V_{GS} = -1.8$ V, $I_D = -8$ A
- Low Profile - 0.8 mm maximum in the new package MicroFET 2x2 mm
- HBM ESD protection level > 2.8 kV typical (Note 3)
- Free from halogenated compounds and antimony oxides
- RoHS Compliant



General Description

This device is designed specifically for battery charge or load switching in cellular handset and other ultraportable applications. It features a MOSFET with low on-state resistance and zener diode protection against ESD. The MicroFET 2X2 package offers exceptional thermal performance for its physical size and is well suited to linear mode applications.

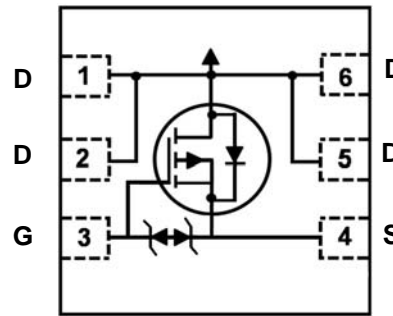
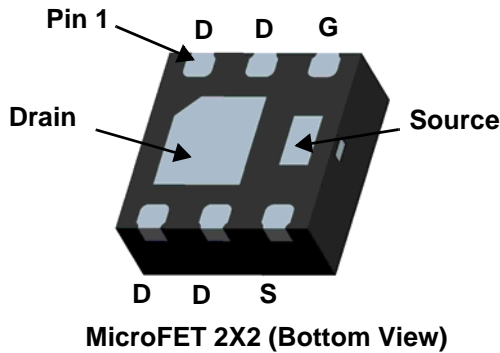

MOSFET Maximum Ratings $T_A = 25$ °C unless otherwise noted

Symbol	Parameter	Ratings	Units
V_{DS}	Drain to Source Voltage	-12	V
V_{GS}	Gate to Source Voltage	±8	V
I_D	Drain Curre -Continuous $T_A = 25$ °C (Note 1a)	-12	A
	-Pulsed	-40	
P_D	Power Dissipation $T_A = 25$ °C (Note 1a)	2.4	W
	Power Dissipation $T_A = 25$ °C (Note 1b)	0.9	
T_J, T_{STG}	Operating and Storage Junction Temperature Range	-55 to +150	°C

Thermal Characteristics

$R_{\theta JA}$	Thermal Resistance, Junction to Ambient (Note 1a)	52	°C/W
$R_{\theta JA}$	Thermal Resistance, Junction to Ambient (Note 1b)	145	

Package Marking and Ordering Information

Device Marking	Device	Package	Reel Size	Tape Width	Quantity
908	FDMA908PZ	MicroFET 2X2	7"	12 mm	3000 units

Electrical Characteristics $T_J = 25\text{ }^\circ\text{C}$ unless otherwise noted

Symbol	Parameter	Test Conditions	Min	Typ	Max	Units
--------	-----------	-----------------	-----	-----	-----	-------

Off Characteristics

BV_{DSS}	Drain to Source Breakdown Voltage	$I_D = -250\text{ }\mu\text{A}$, $V_{GS} = 0\text{ V}$	-12			V
$\frac{\Delta BV_{DSS}}{\Delta T_J}$	Breakdown Voltage Temperature Coefficient	$I_D = -250\text{ }\mu\text{A}$, referenced to $25\text{ }^\circ\text{C}$		-10		mV/ $^\circ\text{C}$
I_{DSS}	Zero Gate Voltage Drain Current	$V_{DS} = -9.6\text{ V}$, $V_{GS} = 0\text{ V}$			-1	μA
I_{GSS}	Gate to Source Leakage Current	$V_{GS} = \pm 8\text{ V}$, $V_{DS} = 0\text{ V}$			± 10	μA

On Characteristics

$V_{GS(th)}$	Gate to Source Threshold Voltage	$V_{GS} = V_{DS}$, $I_D = -250\text{ }\mu\text{A}$	-0.4	-0.6	-1	V
$\frac{\Delta V_{GS(th)}}{\Delta T_J}$	Gate to Source Threshold Voltage Temperature Coefficient	$I_D = -250\text{ }\mu\text{A}$, referenced to $25\text{ }^\circ\text{C}$		2.8		mV/ $^\circ\text{C}$
$r_{DS(on)}$	Static Drain to Source On Resistance	$V_{GS} = -4.5\text{ V}$, $I_D = -12\text{ A}$		10	12.5	m Ω
		$V_{GS} = -2.5\text{ V}$, $I_D = -10\text{ A}$		13	18	
		$V_{GS} = -1.8\text{ V}$, $I_D = -8\text{ A}$		18	28	
		$V_{GS} = -4.5\text{ V}$, $I_D = -12\text{ A}$, $T_J = 125\text{ }^\circ\text{C}$		13	16	
g_{FS}	Forward Transconductance	$V_{DD} = -5\text{ V}$, $I_D = -12\text{ A}$		63		S

Dynamic Characteristics

C_{iss}	Input Capacitance	$V_{DS} = -6\text{ V}$, $V_{GS} = 0\text{ V}$, $f = 1\text{ MHz}$		2638	3957	pF
C_{oss}	Output Capacitance			649	974	pF
C_{rss}	Reverse Transfer Capacitance			602	903	pF

Switching Characteristics

$t_{d(on)}$	Turn-On Delay Time	$V_{DD} = -6\text{ V}$, $I_D = -12\text{ A}$, $V_{GS} = -4.5\text{ V}$, $R_{GEN} = 6\text{ }\Omega$		11	21	ns
t_r	Rise Time			12	23	ns
$t_{d(off)}$	Turn-Off Delay Time			131	223	ns
t_f	Fall Time			71	121	ns
Q_g	Total Gate Charge		$V_{GS} = -4.5\text{ V}$, $V_{DD} = -6\text{ V}$, $I_D = -12\text{ A}$		24	34
Q_{gs}	Gate to Source Charge			3.4		nC
Q_{gd}	Gate to Drain "Miller" Charge			5.3		nC

Drain-Source Diode Characteristics

V_{SD}	Source to Drain Diode Forward Voltage	$V_{GS} = 0\text{ V}$, $I_S = -2\text{ A}$ (Note 2)		-0.6	-1.2	V
		$V_{GS} = 0\text{ V}$, $I_S = -12\text{ A}$ (Note 2)		-0.8	-1.2	V
t_{rr}	Reverse Recovery Time	$I_F = -12\text{ A}$, $di/dt = 100\text{ A}/\mu\text{s}$		26	42	ns
Q_{rr}	Reverse Recovery Charge			8.5	17	nC

NOTES:

- $R_{\theta JA}$ is determined with the device mounted on a 1 in^2 pad 2 oz copper pad on a $1.5 \times 1.5\text{ in.}$ board of FR-4 material. $R_{\theta JC}$ is guaranteed by design while $R_{\theta CA}$ is determined by the user's board design.

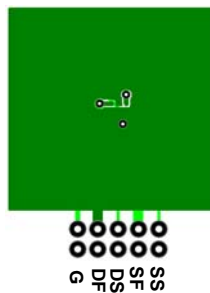

a. $52\text{ }^\circ\text{C}/\text{W}$ when mounted on a 1 in^2 pad of 2 oz copper.



b. $145\text{ }^\circ\text{C}/\text{W}$ when mounted on a minimum pad of 2 oz copper.

- Pulse Test: Pulse Width < $300\text{ }\mu\text{s}$, Duty cycle < 2.0%.

- The diode connected between the gate and source serves only as protection against ESD. No gate overvoltage rating is implied.

Typical Characteristics $T_J = 25\text{ }^\circ\text{C}$ unless otherwise noted

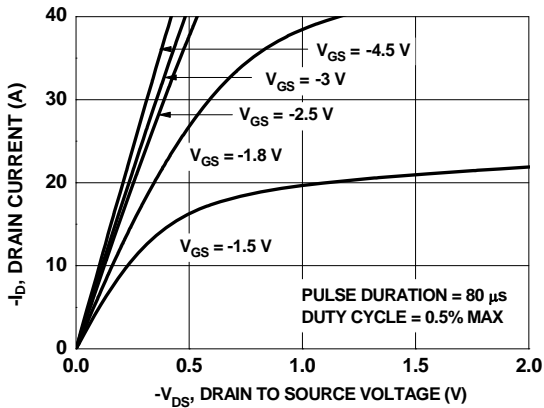

Figure 1. On-Region Characteristics

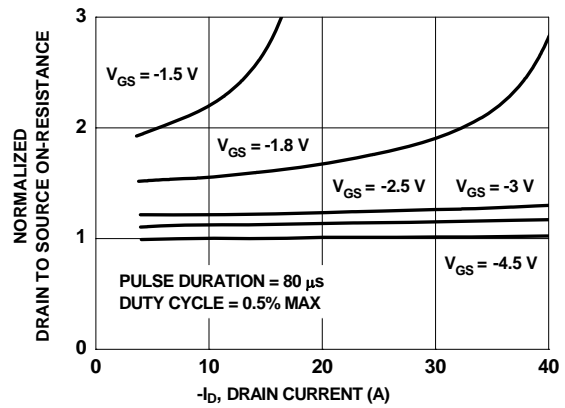

Figure 2. Normalized On-Resistance vs Drain Current and Gate Voltage

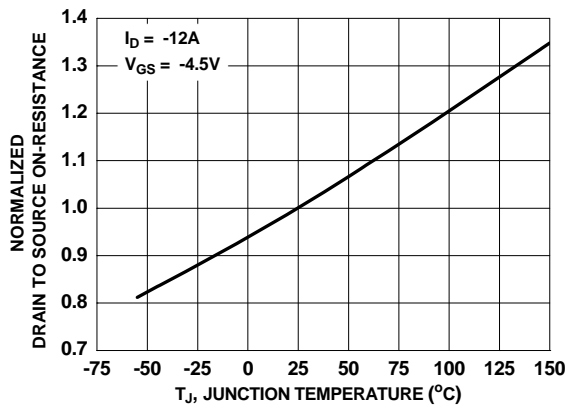

Figure 3. Normalized On-Resistance vs Junction Temperature

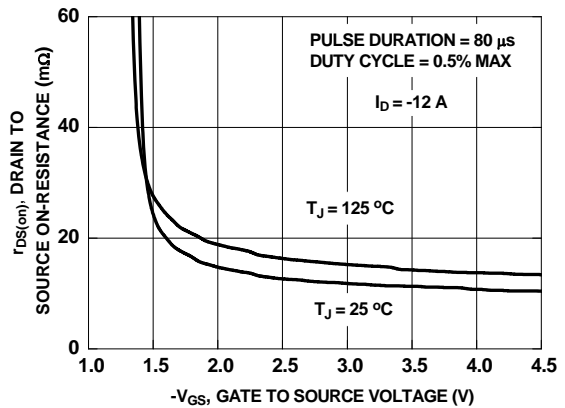

Figure 4. On-Resistance vs Gate to Source Voltage

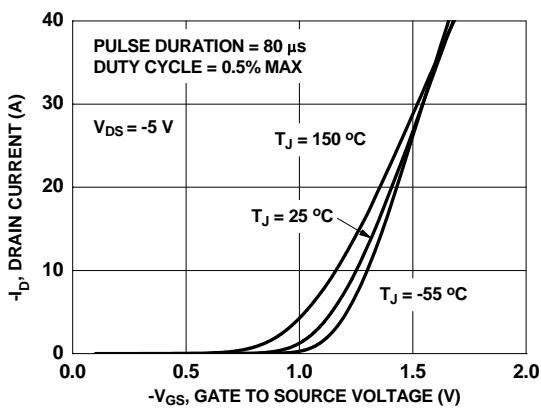

Figure 5. Transfer Characteristics

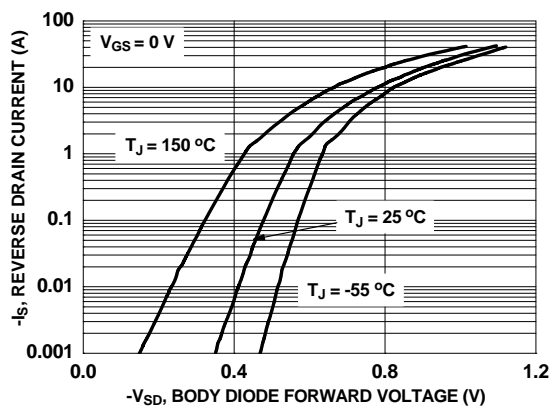

Figure 6. Source to Drain Diode Forward Voltage vs Source Current

Typical Characteristics $T_J = 25\text{ }^\circ\text{C}$ unless otherwise noted

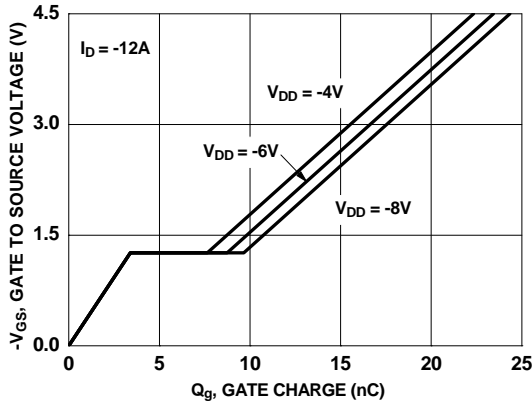

Figure 7. Gate Charge Characteristics

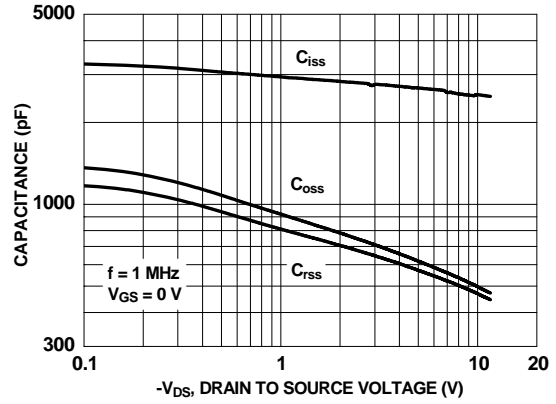

Figure 8. Capacitance vs Drain to Source Voltage

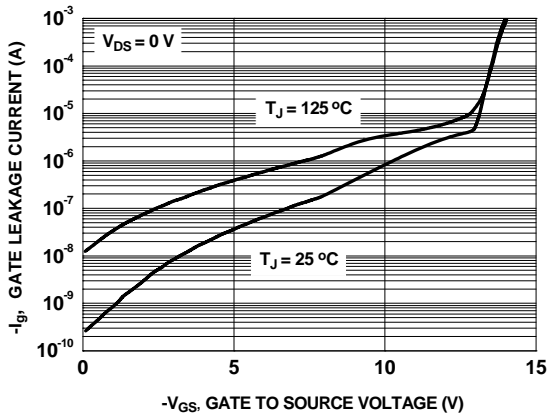

Figure 9. Gate Leakage Current vs Gate to Source Voltage

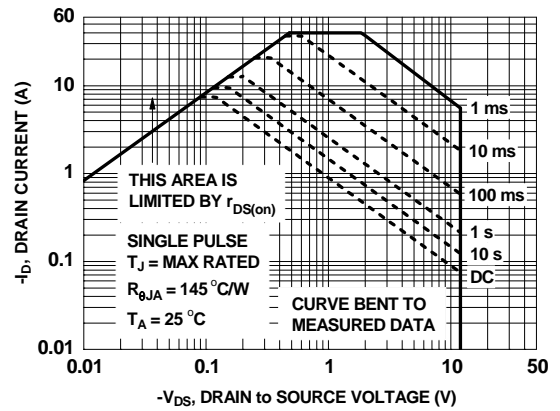

Figure 10. Gate Leakage Current vs Gate to Source Voltage

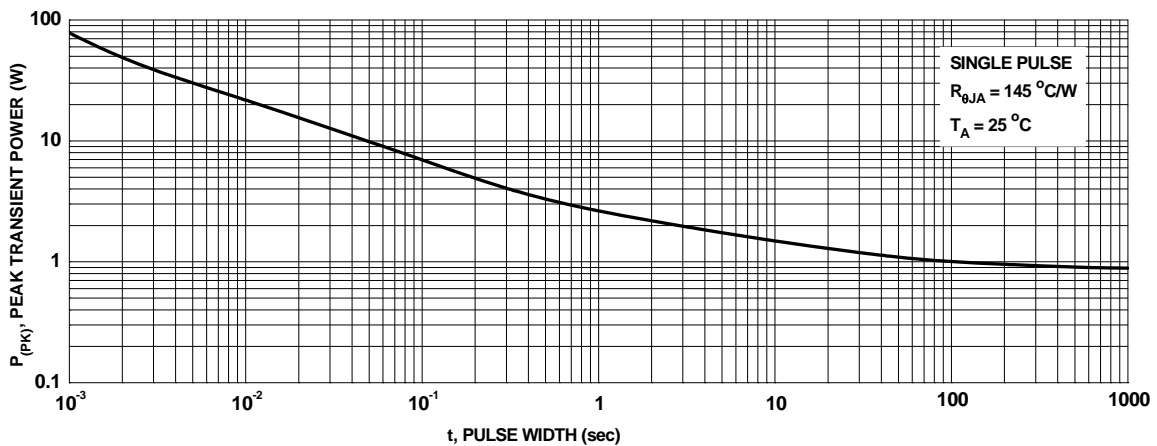

Figure 11. Single Pulse Maximum Power Dissipation

Typical Characteristics $T_J = 25\text{ }^\circ\text{C}$ unless otherwise noted

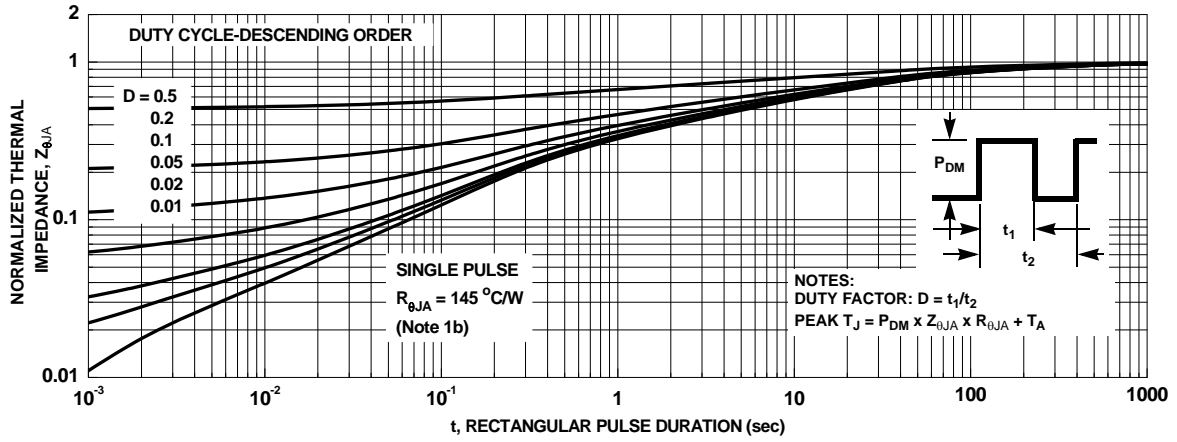
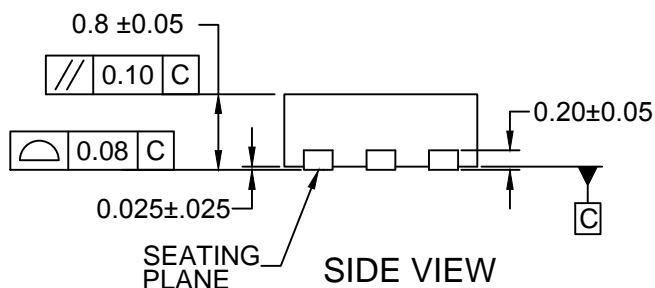
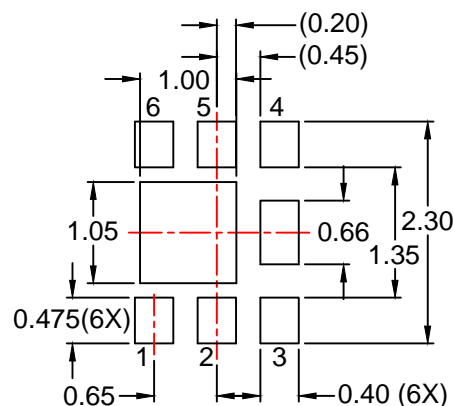
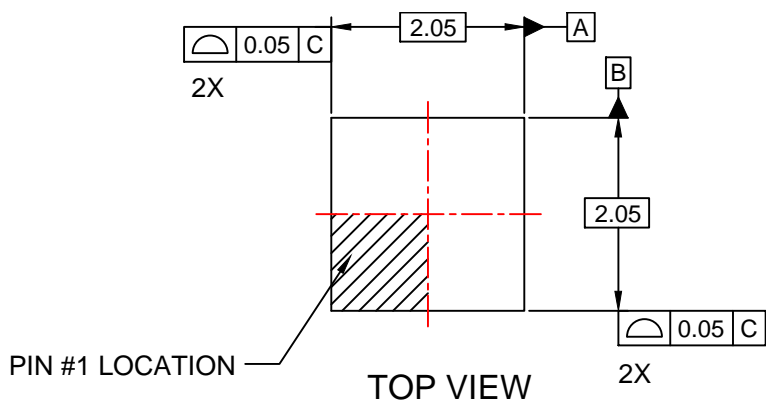
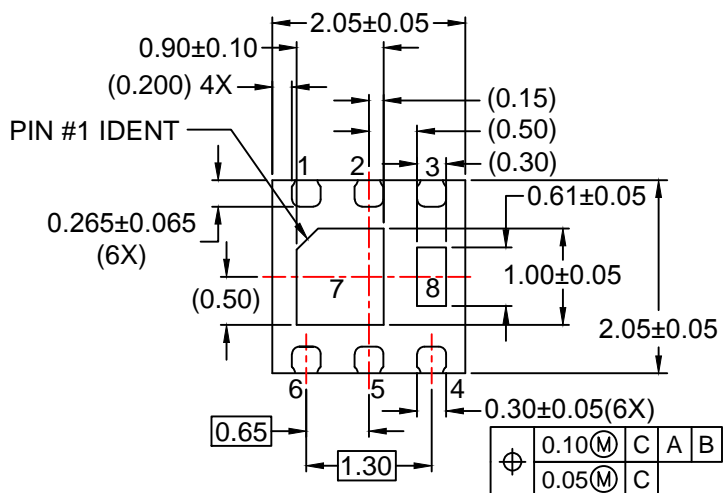

Figure 12. Junction-to-Ambient Transient Thermal Response Curve



RECOMMENDED LAND PATTERN

Pin #	Function
1	Drain
2	Drain
3	Gate
4	Source
5	Drain
6	Drain
7	Drain
8	Source



NOTES:

- PACKAGE DOES NOT CONFORM TO ANY JEDEC STANDARD.
- DIMENSIONS ARE IN MILLIMETERS.
- DIMENSIONS AND TOLERANCES PER ASME Y14.5M, 2009.
- LAND PATTERN RECOMMENDATION IS EXISTING INDUSTRY LAND PATTERN.
- DRAWING FILENAME: MKT-FDMA908Prev1.
- REFERENCE DRAWING NO : MKT-MLP06Prev1.





TRADEMARKS

The following includes registered and unregistered trademarks and service marks, owned by Fairchild Semiconductor and/or its global subsidiaries, and is not intended to be an exhaustive list of all such trademarks.

AccuPower™
AttitudeEngine™
Awinda®
AX-CAP®*
BitSiC™
Build it Now™
CorePLUS™
CorePOWER™
CROSSVOL™
CTL™
Current Transfer Logic™
DEUXPEED®
Dual Cool™
EcoSPARK®
EfficientMax™
ESBC™
F®
Fairchild®
Fairchild Semiconductor®
FACT Quiet Series™
FACT®
FastvCore™
FETBench™
FPS™

F-PFS™
FRFET®
Global Power Resource™
GreenBridge™
Green FPS™
Green FPS™ e-Series™
Gmax™
GTO™
IntelliMAX™
ISOPLANAR™
Making Small Speakers Sound Louder and Better™
MegaBuck™
MICROCOUPLER™
MicroFET™
MicroPak™
MicroPak2™
MillerDrive™
MotionMax™
MotionGrid®
MTi®
MTx®
MVN®
mWSaver®
OptoHiT™
OPTOLOGIC®

OPTOPLANAR®
Power Supply WebDesigner™
PowerTrench®
PowerXS™
Programmable Active Droop™
QFET®
QS™
Quiet Series™
RapidConfigure™
Saving our world, 1mW/W/kW at a time™
SignalWise™
SmartMax™
SMART START™
Solutions for Your Success™
SPM®
STEALTH™
SuperFET®
SuperSOT™-3
SuperSOT™-6
SuperSOT™-8
SupreMOS®
SyncFET™
Sync-Lock™

SYSTEM GENERAL®
TinyBoost®
TinyBuck®
TinyCalc™
TinyLogic®
TINYOPTO™
TinyPower™
TinyPWM™
TinyWire™
TranSiC™
TriFault Detect™
TRUECURRENT®*
µSerDes™
SerDes®
UHC®
Ultra FRFET™
UniFET™
VCX™
VisualMax™
VoltagePlus™
XS™
Xsens™
仙童®

* Trademarks of System General Corporation, used under license by Fairchild Semiconductor.

DISCLAIMER

FAIRCHILD SEMICONDUCTOR RESERVES THE RIGHT TO MAKE CHANGES WITHOUT FURTHER NOTICE TO ANY PRODUCTS HEREIN TO IMPROVE RELIABILITY, FUNCTION, OR DESIGN. TO OBTAIN THE LATEST, MOST UP-TO-DATE DATASHEET AND PRODUCT INFORMATION, VISIT OUR WEBSITE AT [HTTP://WWW.FAIRCHILDSEMI.COM](http://www.fairchildsemi.com). FAIRCHILD DOES NOT ASSUME ANY LIABILITY ARISING OUT OF THE APPLICATION OR USE OF ANY PRODUCT OR CIRCUIT DESCRIBED HEREIN; NEITHER DOES IT CONVEY ANY LICENSE UNDER ITS PATENT RIGHTS, NOR THE RIGHTS OF OTHERS. THESE SPECIFICATIONS DO NOT EXPAND THE TERMS OF FAIRCHILD'S WORLDWIDE TERMS AND CONDITIONS, SPECIFICALLY THE WARRANTY THEREIN, WHICH COVERS THESE PRODUCTS.

AUTHORIZED USE

Unless otherwise specified in this data sheet, this product is a standard commercial product and is not intended for use in applications that require extraordinary levels of quality and reliability. This product may not be used in the following applications, unless specifically approved in writing by a Fairchild officer: (1) automotive or other transportation, (2) military/aerospace, (3) any safety critical application – including life critical medical equipment – where the failure of the Fairchild product reasonably would be expected to result in personal injury, death or property damage. Customer's use of this product is subject to agreement of this Authorized Use policy. In the event of an unauthorized use of Fairchild's product, Fairchild accepts no liability in the event of product failure. In other respects, this product shall be subject to Fairchild's Worldwide Terms and Conditions of Sale, unless a separate agreement has been signed by both Parties.

ANTI-COUNTERFEITING POLICY

Fairchild Semiconductor Corporation's Anti-Counterfeiting Policy. Fairchild's Anti-Counterfeiting Policy is also stated on our external website, www.fairchildsemi.com, under Terms of Use

Counterfeiting of semiconductor parts is a growing problem in the industry. All manufacturers of semiconductor products are experiencing counterfeiting of their parts. Customers who inadvertently purchase counterfeit parts experience many problems such as loss of brand reputation, substandard performance, failed applications, and increased cost of production and manufacturing delays. Fairchild is taking strong measures to protect ourselves and our customers from the proliferation of counterfeit parts. Fairchild strongly encourages customers to purchase Fairchild parts either directly from Fairchild or from Authorized Fairchild Distributors who are listed by country on our web page cited above. Products customers buy either from Fairchild directly or from Authorized Fairchild Distributors are genuine parts, have full traceability, meet Fairchild's quality standards for handling and storage and provide access to Fairchild's full range of up-to-date technical and product information. Fairchild and our Authorized Distributors will stand behind all warranties and will appropriately address any warranty issues that may arise. Fairchild will not provide any warranty coverage or other assistance for parts bought from Unauthorized Sources. Fairchild is committed to combat this global problem and encourage our customers to do their part in stopping this practice by buying direct or from authorized distributors.

PRODUCT STATUS DEFINITIONS

Definition of Terms

Datasheet Identification	Product Status	Definition
Advance Information	Formative / In Design	Datasheet contains the design specifications for product development. Specifications may change in any manner without notice.
Preliminary	First Production	Datasheet contains preliminary data; supplementary data will be published at a later date. Fairchild Semiconductor reserves the right to make changes at any time without notice to improve design.
No Identification Needed	Full Production	Datasheet contains final specifications. Fairchild Semiconductor reserves the right to make changes at any time without notice to improve the design.
Obsolete	Not In Production	Datasheet contains specifications on a product that is discontinued by Fairchild Semiconductor. The datasheet is for reference information only.

Mouser Electronics

Authorized Distributor

Click to View Pricing, Inventory, Delivery & Lifecycle Information:

[Fairchild Semiconductor:](#)

[FDMA908PZ](#)