

# FDP032N08B

## N-Channel PowerTrench® MOSFET

80 V, 211 A, 3.3 mΩ

### Features

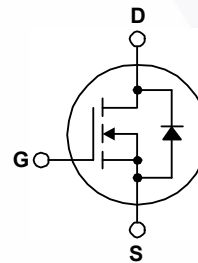
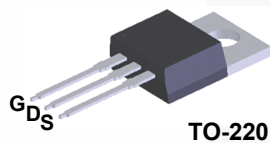
- $R_{DS(on)} = 2.85 \text{ m}\Omega$  (Typ.) @  $V_{GS} = 10 \text{ V}$ ,  $I_D = 50 \text{ A}$
- Low FOM  $R_{DS(on)} \cdot Q_G$
- Low Reverse-Recovery Charge,  $Q_{rr}$
- Soft Reverse-Recovery Body Diode
- Enables High Efficiency in Synchronous Rectification
- Fast Switching Speed
- 100% UIL Tested
- RoHS Compliant

### Description

This N-Channel MOSFET is produced using Fairchild Semiconductor's advanced PowerTrench® process that has been tailored to minimize the on-state resistance while maintaining superior switching performance.

### Applications

- Synchronous Rectification for ATX / Server / Telecom PSU
- Battery Protection Circuit
- Motor Drives and Uninterruptible Power Supplies
- Renewable System



### MOSFET Maximum Ratings $T_C = 25^\circ\text{C}$ unless otherwise noted.

Symbol	Parameter	FDP032N08B_F102	Unit
$V_{DSS}$	Drain to Source Voltage	80	V
$V_{GSS}$	Gate to Source Voltage	$\pm 20$	V
$I_D$	Drain Current	- Continuous ( $T_C = 25^\circ\text{C}$ , Silicon Limited)	211*
		- Continuous ( $T_C = 100^\circ\text{C}$ , Silicon Limited)	149*
		- Continuous ( $T_C = 25^\circ\text{C}$ , Package Limited)	120
$I_{DM}$	Drain Current	- Pulsed (Note 1)	844 A
$E_{AS}$	Single Pulsed Avalanche Energy	(Note 2)	649 mJ
$dv/dt$	Peak Diode Recovery $dv/dt$	(Note 3)	6.0 V/ns
$P_D$	Power Dissipation	( $T_C = 25^\circ\text{C}$ )	263 W
		- Derate Above $25^\circ\text{C}$	1.75 $\text{W}/^\circ\text{C}$
$T_J, T_{STG}$	Operating and Storage Temperature Range	-55 to +175	$^\circ\text{C}$
$T_L$	Maximum Lead Temperature for Soldering, 1/8" from Case for 5 Seconds	300	$^\circ\text{C}$

\* Package limitation current is 120A.

### Thermal Characteristics

Symbol	Parameter	FDP032N08B_F102	Unit
$R_{\theta JC}$	Thermal Resistance, Junction to Case, Max.	0.57	$^\circ\text{C}/\text{W}$
$R_{\theta JA}$	Thermal Resistance, Junction to Ambient, Max.	62.5	

## Package Marking and Ordering Information

Part Number	Top Mark	Package	Packing Method	Reel Size	Tape Width	Quantity
FDP032N08B_F102	FDP032N08B	TO-220	Tube	N/A	N/A	50 units

## Electrical Characteristics $T_C = 25^\circ\text{C}$ unless otherwise noted.

Symbol	Parameter	Test Conditions	Min.	Typ.	Max.	Unit
--------	-----------	-----------------	------	------	------	------

### Off Characteristics

$BV_{DSS}$	Drain to Source Breakdown Voltage	$I_D = 250 \mu\text{A}, V_{GS} = 0 \text{ V}$	80	-	-	V
$\Delta BV_{DSS} / \Delta T_J$	Breakdown Voltage Temperature Coefficient	$I_D = 250 \mu\text{A}$ , Referenced to $25^\circ\text{C}$	-	0.04	-	$\text{V}/^\circ\text{C}$
$I_{DSS}$	Zero Gate Voltage Drain Current	$V_{DS} = 64 \text{ V}, V_{GS} = 0 \text{ V}$ $V_{DS} = 64 \text{ V}, T_C = 150^\circ\text{C}$	-	-	1 500	$\mu\text{A}$
$I_{GSS}$	Gate to Body Leakage Current	$V_{GS} = \pm 20 \text{ V}, V_{DS} = 0 \text{ V}$	-	-	$\pm 100$	nA

### On Characteristics

$V_{GS(th)}$	Gate Threshold Voltage	$V_{GS} = V_{DS}, I_D = 250 \mu\text{A}$	2.5	-	4.5	V
$R_{DS(on)}$	Static Drain to Source On Resistance	$V_{GS} = 10 \text{ V}, I_D = 100 \text{ A}$	-	2.85	3.3	$\text{m}\Omega$
$g_{FS}$	Forward Transconductance	$V_{DS} = 10 \text{ V}, I_D = 100 \text{ A}$	-	168	-	S

### Dynamic Characteristics

$C_{iss}$	Input Capacitance	$V_{DS} = 40 \text{ V}, V_{GS} = 0 \text{ V},$ $f = 1 \text{ MHz}$	-	8245	10965	pF
$C_{oss}$	Output Capacitance		-	1250	1660	pF
$C_{rSS}$	Reverse Transfer Capacitance		-	28	-	pF
$C_{oss(er)}$	Energy Related Output Capacitance	$V_{DS} = 40 \text{ V}, V_{GS} = 0 \text{ V}$	-	2337	-	pF
$Q_{g(tot)}$	Total Gate Charge at 10V	$V_{DS} = 40 \text{ V}, I_D = 100 \text{ A},$ $V_{GS} = 10 \text{ V}$	-	111	144	nC
$Q_{gs}$	Gate to Source Gate Charge		-	44	-	nC
$Q_{gd}$	Gate to Drain "Miller" Charge		-	23	-	nC
$V_{plateau}$	Gate Plateau Voltage		(Note 4)	-	5.6	-
$Q_{sync}$	Total Gate Charge Sync.	$V_{DS} = 0 \text{ V}, I_D = 50 \text{ A}$	-	98.2	-	nC
$Q_{oss}$	Output Charge	$V_{DS} = 40 \text{ V}, V_{GS} = 0 \text{ V}$	-	114	-	nC
ESR	Equivalent Series Resistance (G-S)	$f = 1 \text{ MHz}$	-	2.3	-	$\Omega$

### Switching Characteristics

$t_{d(on)}$	Turn-On Delay Time	$V_{DD} = 40 \text{ V}, I_D = 100 \text{ A},$ $V_{GS} = 10 \text{ V}, R_G = 4.7 \Omega$	-	38	86	ns
$t_r$	Turn-On Rise Time		-	44	97	ns
$t_{d(off)}$	Turn-Off Delay Time		-	71	152	ns
$t_f$	Turn-Off Fall Time		(Note 4)	-	31	72

### Drain-Source Diode Characteristics

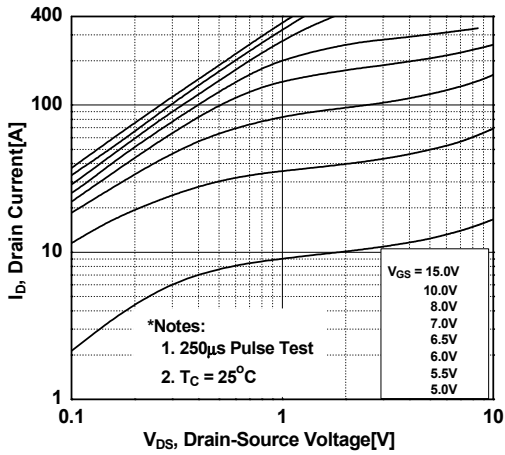
$I_S$	Maximum Continuous Drain to Source Diode Forward Current	-	-	211	A	
$I_{SM}$	Maximum Pulsed Drain to Source Diode Forward Current	-	-	844	A	
$V_{SD}$	Drain to Source Diode Forward Voltage	$V_{GS} = 0 \text{ V}, I_{SD} = 100 \text{ A}$	-	-	1.3	V
$t_{rr}$	Reverse Recovery Time	$V_{GS} = 0 \text{ V}, V_{DD} = 40 \text{ V}, I_{SD} = 100 \text{ A},$	-	75	-	ns
$Q_{rr}$	Reverse Recovery Charge	$di_F/dt = 100 \text{ A}/\mu\text{s}$	-	102	-	nC

#### Notes:

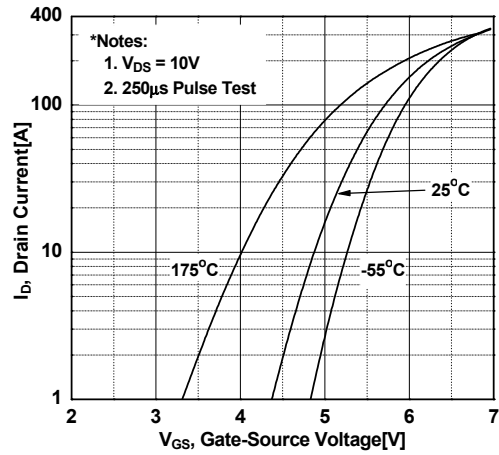
- Repetitive rating; pulse-width limited by maximum junction temperature.
- $L = 3 \text{ mH}, I_{AS} = 20.8 \text{ A}$ , starting  $T_J = 25^\circ\text{C}$ .
- $I_{SD} \leq 100 \text{ A}, di/dt \leq 200 \text{ A}/\mu\text{s}, V_{DD} \leq BV_{DSS}$ , starting  $T_J = 25^\circ\text{C}$ .
- Essentially independent of operating temperature typical characteristics.

## Typical Performance Characteristics

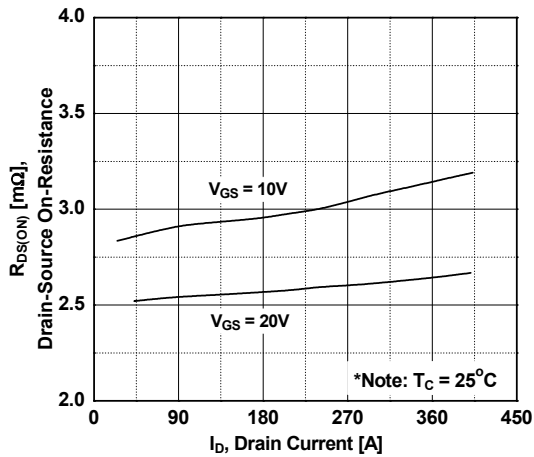
**Figure 1. On-Region Characteristics**



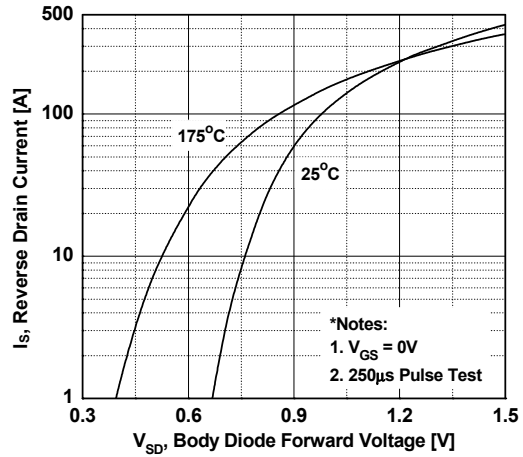
**Figure 2. Transfer Characteristics**



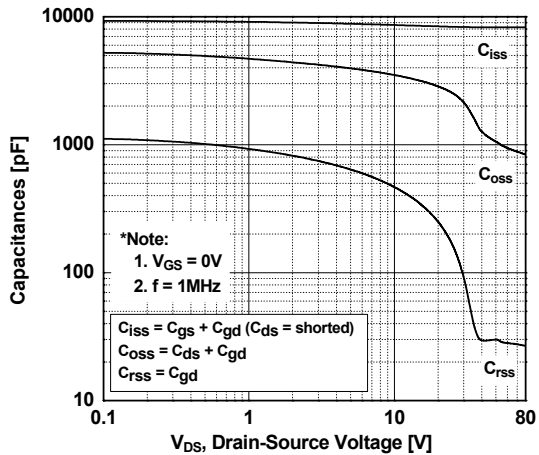
**Figure 3. On-Resistance Variation vs. Drain Current and Gate Voltage**



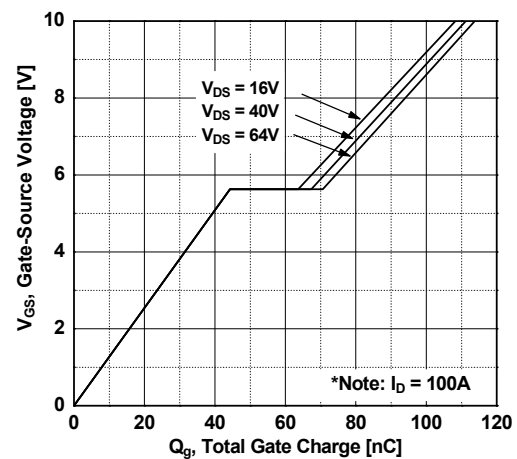
**Figure 4. Body Diode Forward Voltage Variation vs. Source Current and Temperature**



**Figure 5. Capacitance Characteristics**

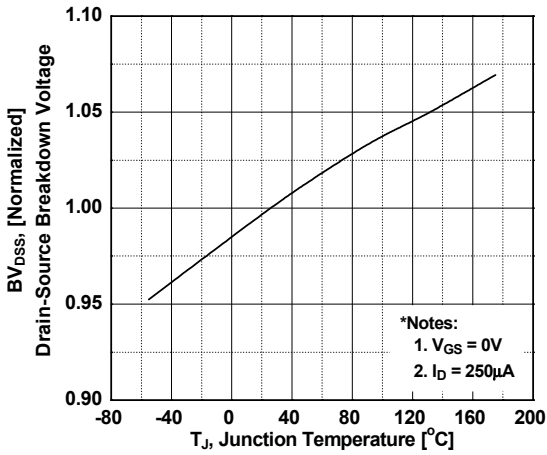


**Figure 6. Gate Charge Characteristics**

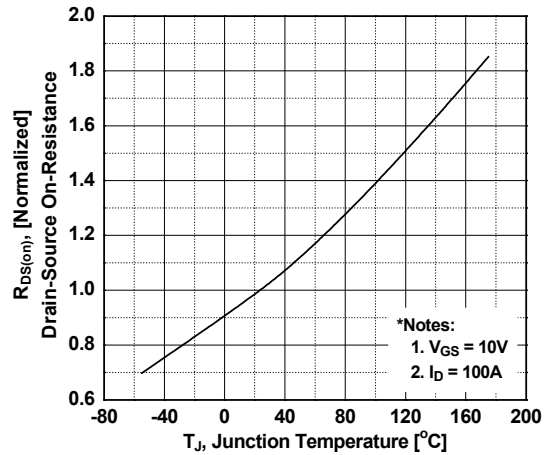


**Typical Performance Characteristics** (Continued)

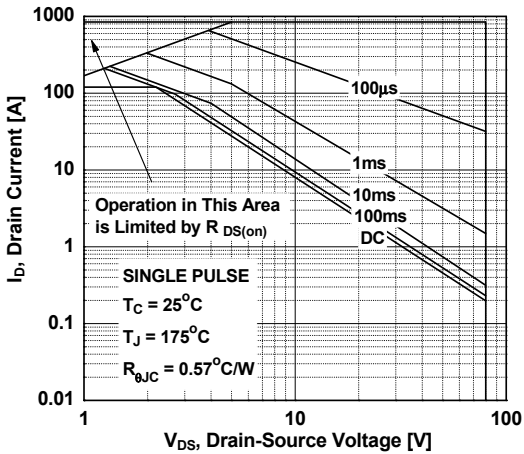
**Figure 7. Breakdown Voltage Variation vs. Temperature**



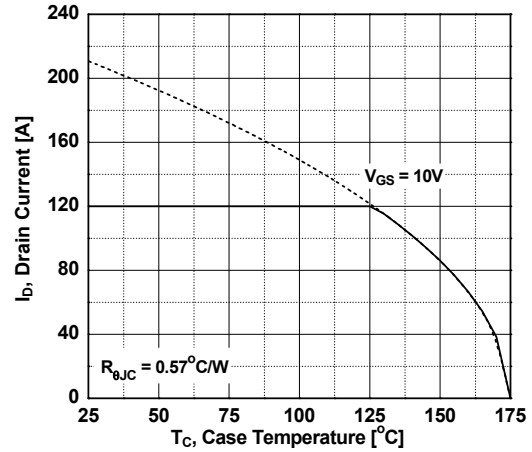
**Figure 8. On-Resistance Variation vs. Temperature**



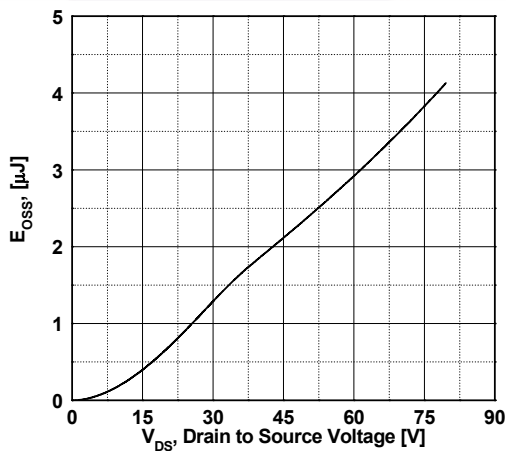
**Figure 9. Maximum Safe Operating Area**



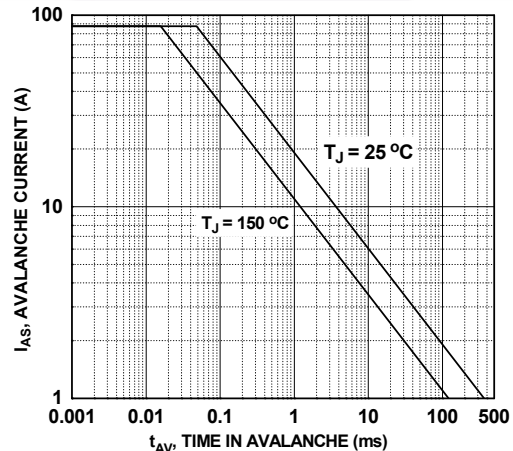
**Figure 10. Maximum Drain Current vs. Case Temperature**



**Figure 11. E\_oss vs. Drain to Source Voltage**

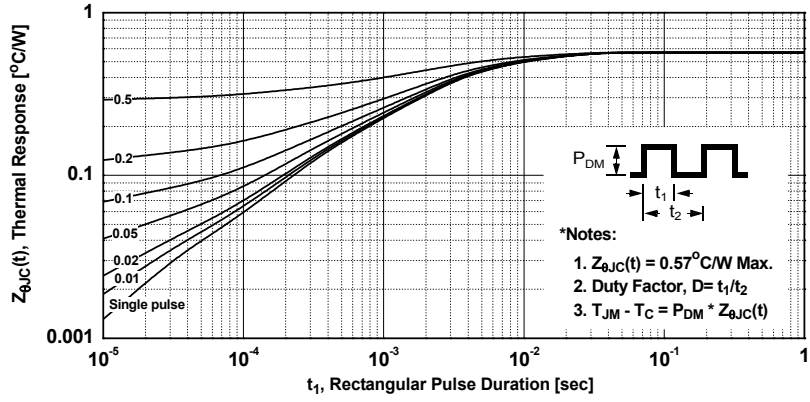


**Figure 12. Unclamped Inductive Switching Capability**



Typical Performance Characteristics (Continued)

Figure 13. Transient Thermal Response Curve





**Figure 14. Gate Charge Test Circuit & Waveform**



**Figure 15. Resistive Switching Test Circuit & Waveforms**



**Figure 16. Unclamped Inductive Switching Test Circuit & Waveforms**



Figure 17. Peak Diode Recovery  $dv/dt$  Test Circuit & Waveforms

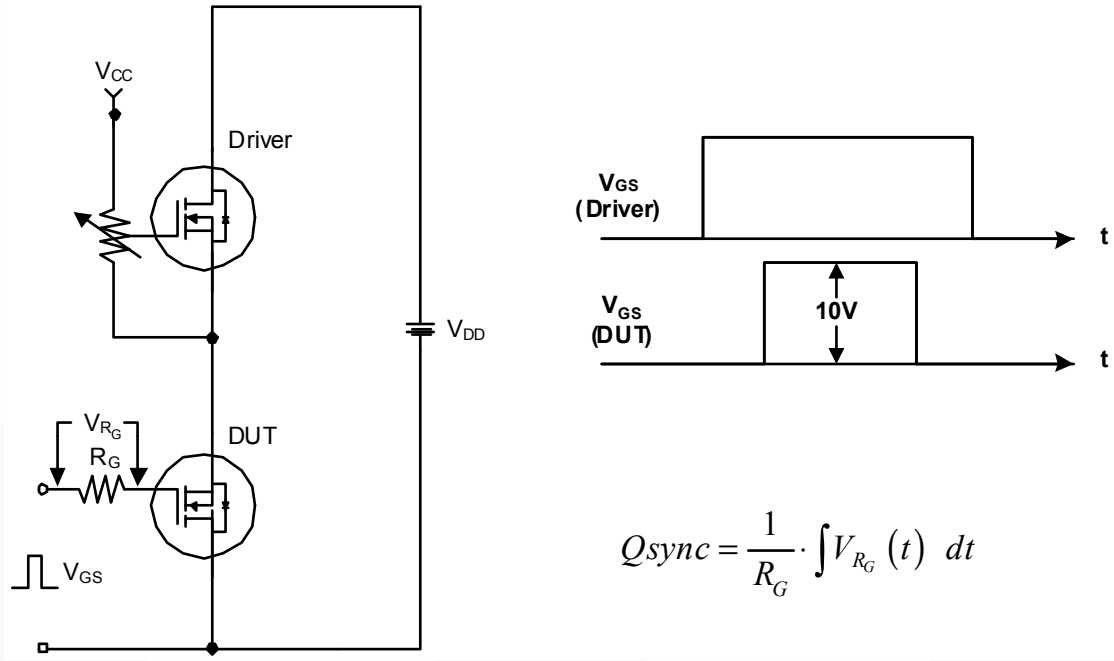
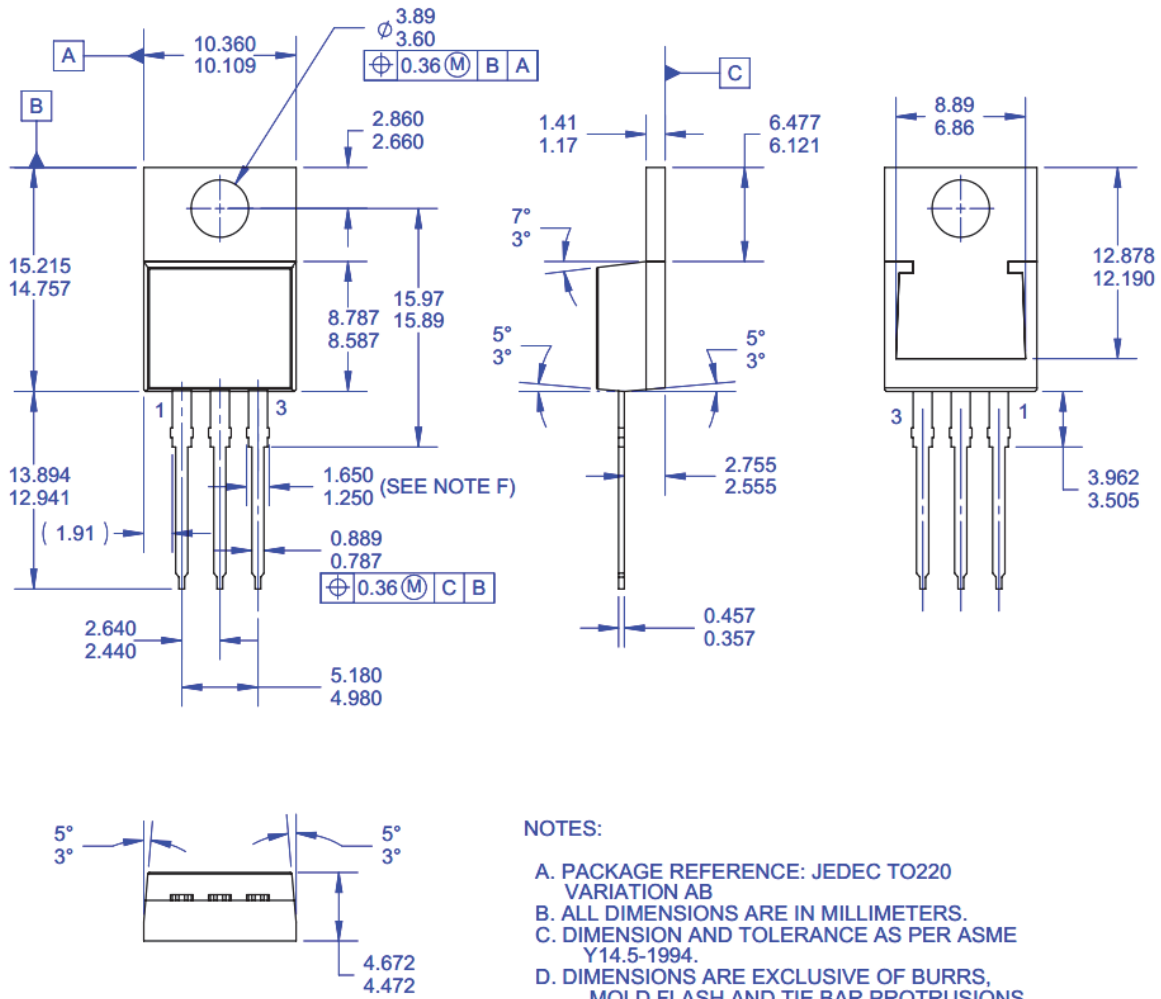


Figure 18. Total Gate Charge  $Q_{sync}$ . Test Circuit & Waveforms



## Mechanical Dimensions



**Figure 19. TO-220, Molded, 3-Lead, Jedec Variation AB (Delta)**

Package drawings are provided as a service to customers considering Fairchild components. Drawings may change in any manner without notice. Please note the revision and/or date on the drawing and contact a Fairchild Semiconductor representative to verify or obtain the most recent revision. Package specifications do not expand the terms of Fairchild's worldwide terms and conditions, specifically the warranty therein, which covers Fairchild products.

Always visit Fairchild Semiconductor's online packaging area for the most recent package drawings:

[http://www.fairchildsemi.com/package/packageDetails.html?id=PN\\_TT220-013](http://www.fairchildsemi.com/package/packageDetails.html?id=PN_TT220-013)



**TRADEMARKS**

The following includes registered and unregistered trademarks and service marks, owned by Fairchild Semiconductor and/or its global subsidiaries, and is not intended to be an exhaustive list of all such trademarks.

- |                          |                                     |                                                 |                  |
|--------------------------|-------------------------------------|-------------------------------------------------|------------------|
| AccuPower™               | F-PFS™                              | PowerTrench®                                    | Sync-Lock™       |
| AX-CAP®*                 | FRFET®                              | PowerXS™                                        | SYSTEM GENERAL®* |
| BitSiC™                  | Global Power Resource <sup>SM</sup> | Programmable Active Droop™                      | TinyBoost®       |
| Build it Now™            | GreenBridge™                        | QFET®                                           | TinyBuck®        |
| CorePLUS™                | Green FPS™                          | QS™                                             | TinyCalc™        |
| CorePOWER™               | Green FPS™ e-Series™                | Quiet Series™                                   | TinyLogic®       |
| CROSSVOLT™               | Gmax™                               | RapidConfigure™                                 | TINYOPTO™        |
| CTL™                     | GTO™                                | ISOPLANAR™                                      | TinyPower™       |
| Current Transfer Logic™  | IntelliMAX™                         | Marking Small Speakers Sound Louder and Better™ | TinyPWM™         |
| DEUXPEED®                | ISOPLANAR™                          | MegaBuck™                                       | TinyWire™        |
| Dual Cool™               | MicroFET™                           | MICROCOUPLER™                                   | TranSiC™         |
| EcoSPARK®                | MicroPak™                           | MicroPak2™                                      | TriFault Detect™ |
| EfficientMax™            | MillerDrive™                        | MotionMax™                                      | TRUECURRENT®*    |
| ESBC™                    | FAST Quiet Series™                  | mWSaver®                                        | µSerDes™         |
| <b>F</b> ®               | FACT®                               | OptoHiT™                                        | <b>µ</b> SerDes™ |
| Fairchild®               | FAST®                               | OPTOLOGIC®                                      | UHC®             |
| Fairchild Semiconductor® | FastvCore™                          | OPTOPLANAR®                                     | Ultra FRFET™     |
| FACT Quiet Series™       | FETBench™                           | PowerTrench®                                    | UniFET™          |
| FACT®                    | FPS™                                | PowerXS™                                        | VCX™             |
| FAST®                    |                                     | Programmable Active Droop™                      | VisualMax™       |
| FastvCore™               |                                     | QFET®                                           | VoltagePlus™     |
| FETBench™                |                                     | QS™                                             | XS™              |
| FPS™                     |                                     | Quiet Series™                                   |                  |
|                          |                                     | RapidConfigure™                                 |                  |
|                          |                                     | ISOPLANAR™                                      |                  |
|                          |                                     | Marking Small Speakers Sound Louder and Better™ |                  |
|                          |                                     | MegaBuck™                                       |                  |
|                          |                                     | MICROCOUPLER™                                   |                  |
|                          |                                     | MicroFET™                                       |                  |
|                          |                                     | MicroPak™                                       |                  |
|                          |                                     | MicroPak2™                                      |                  |
|                          |                                     | MillerDrive™                                    |                  |
|                          |                                     | MotionMax™                                      |                  |
|                          |                                     | mWSaver®                                        |                  |
|                          |                                     | OptoHiT™                                        |                  |
|                          |                                     | OPTOLOGIC®                                      |                  |
|                          |                                     | OPTOPLANAR®                                     |                  |
|                          |                                     | PowerTrench®                                    |                  |
|                          |                                     | PowerXS™                                        |                  |
|                          |                                     | Programmable Active Droop™                      |                  |
|                          |                                     | QFET®                                           |                  |
|                          |                                     | QS™                                             |                  |
|                          |                                     | Quiet Series™                                   |                  |
|                          |                                     | RapidConfigure™                                 |                  |
|                          |                                     | ISOPLANAR™                                      |                  |
|                          |                                     | Marking Small Speakers Sound Louder and Better™ |                  |
|                          |                                     | MegaBuck™                                       |                  |
|                          |                                     | MICROCOUPLER™                                   |                  |
|                          |                                     | MicroFET™                                       |                  |
|                          |                                     | MicroPak™                                       |                  |
|                          |                                     | MicroPak2™                                      |                  |
|                          |                                     | MillerDrive™                                    |                  |
|                          |                                     | MotionMax™                                      |                  |
|                          |                                     | mWSaver®                                        |                  |
|                          |                                     | OptoHiT™                                        |                  |
|                          |                                     | OPTOLOGIC®                                      |                  |
|                          |                                     | OPTOPLANAR®                                     |                  |
|                          |                                     | PowerTrench®                                    |                  |
|                          |                                     | PowerXS™                                        |                  |
|                          |                                     | Programmable Active Droop™                      |                  |
|                          |                                     | QFET®                                           |                  |
|                          |                                     | QS™                                             |                  |
|                          |                                     | Quiet Series™                                   |                  |
|                          |                                     | RapidConfigure™                                 |                  |
|                          |                                     | ISOPLANAR™                                      |                  |
|                          |                                     | Marking Small Speakers Sound Louder and Better™ |                  |
|                          |                                     | MegaBuck™                                       |                  |
|                          |                                     | MICROCOUPLER™                                   |                  |
|                          |                                     | MicroFET™                                       |                  |
|                          |                                     | MicroPak™                                       |                  |
|                          |                                     | MicroPak2™                                      |                  |
|                          |                                     | MillerDrive™                                    |                  |
|                          |                                     | MotionMax™                                      |                  |
|                          |                                     | mWSaver®                                        |                  |
|                          |                                     | OptoHiT™                                        |                  |
|                          |                                     | OPTOLOGIC®                                      |                  |
|                          |                                     | OPTOPLANAR®                                     |                  |
|                          |                                     | PowerTrench®                                    |                  |
|                          |                                     | PowerXS™                                        |                  |
|                          |                                     | Programmable Active Droop™                      |                  |
|                          |                                     | QFET®                                           |                  |
|                          |                                     | QS™                                             |                  |
|                          |                                     | Quiet Series™                                   |                  |
|                          |                                     | RapidConfigure™                                 |                  |
|                          |                                     | ISOPLANAR™                                      |                  |
|                          |                                     | Marking Small Speakers Sound Louder and Better™ |                  |
|                          |                                     | MegaBuck™                                       |                  |
|                          |                                     | MICROCOUPLER™                                   |                  |
|                          |                                     | MicroFET™                                       |                  |
|                          |                                     | MicroPak™                                       |                  |
|                          |                                     | MicroPak2™                                      |                  |
|                          |                                     | MillerDrive™                                    |                  |
|                          |                                     | MotionMax™                                      |                  |
|                          |                                     | mWSaver®                                        |                  |
|                          |                                     | OptoHiT™                                        |                  |
|                          |                                     | OPTOLOGIC®                                      |                  |
|                          |                                     | OPTOPLANAR®                                     |                  |
|                          |                                     | PowerTrench®                                    |                  |
|                          |                                     | PowerXS™                                        |                  |
|                          |                                     | Programmable Active Droop™                      |                  |
|                          |                                     | QFET®                                           |                  |
|                          |                                     | QS™                                             |                  |
|                          |                                     | Quiet Series™                                   |                  |
|                          |                                     | RapidConfigure™                                 |                  |
|                          |                                     | ISOPLANAR™                                      |                  |
|                          |                                     | Marking Small Speakers Sound Louder and Better™ |                  |
|                          |                                     | MegaBuck™                                       |                  |
|                          |                                     | MICROCOUPLER™                                   |                  |
|                          |                                     | MicroFET™                                       |                  |
|                          |                                     | MicroPak™                                       |                  |
|                          |                                     | MicroPak2™                                      |                  |
|                          |                                     | MillerDrive™                                    |                  |
|                          |                                     | MotionMax™                                      |                  |
|                          |                                     | mWSaver®                                        |                  |
|                          |                                     | OptoHiT™                                        |                  |
|                          |                                     | OPTOLOGIC®                                      |                  |
|                          |                                     | OPTOPLANAR®                                     |                  |
|                          |                                     | PowerTrench®                                    |                  |
|                          |                                     | PowerXS™                                        |                  |
|                          |                                     | Programmable Active Droop™                      |                  |
|                          |                                     | QFET®                                           |                  |
|                          |                                     | QS™                                             |                  |
|                          |                                     | Quiet Series™                                   |                  |
|                          |                                     | RapidConfigure™                                 |                  |
|                          |                                     | ISOPLANAR™                                      |                  |
|                          |                                     | Marking Small Speakers Sound Louder and Better™ |                  |
|                          |                                     | MegaBuck™                                       |                  |
|                          |                                     | MICROCOUPLER™                                   |                  |
|                          |                                     | MicroFET™                                       |                  |
|                          |                                     | MicroPak™                                       |                  |
|                          |                                     | MicroPak2™                                      |                  |
|                          |                                     | MillerDrive™                                    |                  |
|                          |                                     | MotionMax™                                      |                  |
|                          |                                     | mWSaver®                                        |                  |
|                          |                                     | OptoHiT™                                        |                  |
|                          |                                     | OPTOLOGIC®                                      |                  |
|                          |                                     | OPTOPLANAR®                                     |                  |
|                          |                                     | PowerTrench®                                    |                  |
|                          |                                     | PowerXS™                                        |                  |
|                          |                                     | Programmable Active Droop™                      |                  |
|                          |                                     | QFET®                                           |                  |
|                          |                                     | QS™                                             |                  |
|                          |                                     | Quiet Series™                                   |                  |
|                          |                                     | RapidConfigure™                                 |                  |
|                          |                                     | ISOPLANAR™                                      |                  |
|                          |                                     | Marking Small Speakers Sound Louder and Better™ |                  |
|                          |                                     | MegaBuck™                                       |                  |
|                          |                                     | MICROCOUPLER™                                   |                  |
|                          |                                     | MicroFET™                                       |                  |
|                          |                                     | MicroPak™                                       |                  |
|                          |                                     | MicroPak2™                                      |                  |
|                          |                                     | MillerDrive™                                    |                  |
|                          |                                     | MotionMax™                                      |                  |
|                          |                                     | mWSaver®                                        |                  |
|                          |                                     | OptoHiT™                                        |                  |
|                          |                                     | OPTOLOGIC®                                      |                  |
|                          |                                     | OPTOPLANAR®                                     |                  |
|                          |                                     | PowerTrench®                                    |                  |
|                          |                                     | PowerXS™                                        |                  |
|                          |                                     | Programmable Active Droop™                      |                  |
|                          |                                     | QFET®                                           |                  |
|                          |                                     | QS™                                             |                  |
|                          |                                     | Quiet Series™                                   |                  |
|                          |                                     | RapidConfigure™                                 |                  |
|                          |                                     | ISOPLANAR™                                      |                  |
|                          |                                     | Marking Small Speakers Sound Louder and Better™ |                  |
|                          |                                     | MegaBuck™                                       |                  |
|                          |                                     | MICROCOUPLER™                                   |                  |
|                          |                                     | MicroFET™                                       |                  |
|                          |                                     | MicroPak™                                       |                  |
|                          |                                     | MicroPak2™                                      |                  |
|                          |                                     | MillerDrive™                                    |                  |
|                          |                                     | MotionMax™                                      |                  |
|                          |                                     | mWSaver®                                        |                  |
|                          |                                     | OptoHiT™                                        |                  |
|                          |                                     | OPTOLOGIC®                                      |                  |
|                          |                                     | OPTOPLANAR®                                     |                  |
|                          |                                     | PowerTrench®                                    |                  |
|                          |                                     | PowerXS™                                        |                  |
|                          |                                     | Programmable Active Droop™                      |                  |
|                          |                                     | QFET®                                           |                  |
|                          |                                     | QS™                                             |                  |
|                          |                                     | Quiet Series™                                   |                  |
|                          |                                     | RapidConfigure™                                 |                  |
|                          |                                     | ISOPLANAR™                                      |                  |
|                          |                                     | Marking Small Speakers Sound Louder and Better™ |                  |
|                          |                                     | MegaBuck™                                       |                  |
|                          |                                     | MICROCOUPLER™                                   |                  |
|                          |                                     | MicroFET™                                       |                  |
|                          |                                     | MicroPak™                                       |                  |
|                          |                                     | MicroPak2™                                      |                  |
|                          |                                     | MillerDrive™                                    |                  |
|                          |                                     | MotionMax™                                      |                  |
|                          |                                     | mWSaver®                                        |                  |
|                          |                                     | OptoHiT™                                        |                  |
|                          |                                     | OPTOLOGIC®                                      |                  |
|                          |                                     | OPTOPLANAR®                                     |                  |
|                          |                                     | PowerTrench®                                    |                  |
|                          |                                     | PowerXS™                                        |                  |
|                          |                                     | Programmable Active Droop™                      |                  |
|                          |                                     | QFET®                                           |                  |
|                          |                                     | QS™                                             |                  |
|                          |                                     | Quiet Series™                                   |                  |
|                          |                                     | RapidConfigure™                                 |                  |
|                          |                                     | ISOPLANAR™                                      |                  |
|                          |                                     | Marking Small Speakers Sound Louder and Better™ |                  |
|                          |                                     | MegaBuck™                                       |                  |
|                          |                                     | MICROCOUPLER™                                   |                  |
|                          |                                     | MicroFET™                                       |                  |
|                          |                                     | MicroPak™                                       |                  |
|                          |                                     | MicroPak2™                                      |                  |
|                          |                                     | MillerDrive™                                    |                  |
|                          |                                     | MotionMax™                                      |                  |
|                          |                                     | mWSaver®                                        |                  |
|                          |                                     | OptoHiT™                                        |                  |
|                          |                                     | OPTOLOGIC®                                      |                  |
|                          |                                     | OPTOPLANAR®                                     |                  |
|                          |                                     | PowerTrench®                                    |                  |
|                          |                                     | PowerXS™                                        |                  |
|                          |                                     | Programmable Active Droop™                      |                  |
|                          |                                     | QFET®                                           |                  |
|                          |                                     | QS™                                             |                  |
|                          |                                     | Quiet Series™                                   |                  |
|                          |                                     | RapidConfigure™                                 |                  |
|                          |                                     | ISOPLANAR™                                      |                  |
|                          |                                     | Marking Small Speakers Sound Louder and Better™ |                  |
|                          |                                     | MegaBuck™                                       |                  |
|                          |                                     | MICROCOUPLER™                                   |                  |
|                          |                                     | MicroFET™                                       |                  |
|                          |                                     | MicroPak™                                       |                  |
|                          |                                     | MicroPak2™                                      |                  |
|                          |                                     | MillerDrive™                                    |                  |
|                          |                                     | MotionMax™                                      |                  |
|                          |                                     | mWSaver®                                        |                  |
|                          |                                     | OptoHiT™                                        |                  |
|                          |                                     | OPTOLOGIC®                                      |                  |
|                          |                                     | OPTOPLANAR®                                     |                  |
|                          |                                     | PowerTrench®                                    |                  |
|                          |                                     | PowerXS™                                        |                  |
|                          |                                     | Programmable Active Droop™                      |                  |
|                          |                                     | QFET®                                           |                  |
|                          |                                     | QS™                                             |                  |
|                          |                                     | Quiet Series™                                   |                  |
|                          |                                     | RapidConfigure™                                 |                  |
|                          |                                     | ISOPLANAR™                                      |                  |
|                          |                                     | Marking Small Speakers Sound Louder and Better™ |                  |
|                          |                                     | MegaBuck™                                       |                  |
|                          |                                     | MICROCOUPLER™                                   |                  |
|                          |                                     | MicroFET™                                       |                  |
|                          |                                     | MicroPak™                                       |                  |
|                          |                                     | MicroPak2™                                      |                  |
|                          |                                     | MillerDrive™                                    |                  |
|                          |                                     | MotionMax™                                      |                  |
|                          |                                     | mWSaver®                                        |                  |
|                          |                                     | OptoHiT™                                        |                  |
|                          |                                     | OPTOLOGIC®                                      |                  |
|                          |                                     | OPTOPLANAR®                                     |                  |
|                          |                                     | PowerTrench®                                    |                  |
|                          |                                     | PowerXS™                                        |                  |
|                          |                                     | Programmable Active Droop™                      |                  |
|                          |                                     | QFET®                                           |                  |
|                          |                                     | QS™                                             |                  |
|                          |                                     | Quiet Series™                                   |                  |
|                          |                                     | RapidConfigure™                                 |                  |
|                          |                                     | ISOPLANAR™                                      |                  |
|                          |                                     | Marking Small Speakers Sound Louder and Better™ |                  |
|                          |                                     | MegaBuck™                                       |                  |
|                          |                                     | MICROCOUPLER™                                   |                  |
|                          |                                     | MicroFET™                                       |                  |
|                          |                                     | MicroPak™                                       |                  |
|                          |                                     | MicroPak2™                                      |                  |
|                          |                                     | MillerDrive™                                    |                  |
|                          |                                     | MotionMax™                                      |                  |
|                          |                                     | mWSaver®                                        |                  |
|                          |                                     | OptoHiT™                                        |                  |
|                          |                                     | OPTOLOGIC®                                      |                  |
|                          |                                     | OPTOPLANAR®                                     |                  |
|                          |                                     | PowerTrench®                                    |                  |
|                          |                                     | PowerXS™                                        |                  |
|                          |                                     | Programmable Active Droop™                      |                  |
|                          |                                     | QFET®                                           |                  |
|                          |                                     | QS™                                             |                  |
|                          |                                     | Quiet Series™                                   |                  |
|                          |                                     | RapidConfigure™                                 |                  |
|                          |                                     | ISOPLANAR™                                      |                  |
|                          |                                     | Marking Small Speakers Sound Louder and Better™ |                  |
|                          |                                     | MegaBuck™                                       |                  |
|                          |                                     | MICROCOUPLER™                                   |                  |
|                          |                                     | MicroFET™                                       |                  |
|                          |                                     | MicroPak™                                       |                  |
|                          |                                     | MicroPak2™                                      |                  |
|                          |                                     | MillerDrive™                                    |                  |
|                          |                                     | MotionMax™                                      |                  |
|                          |                                     | mWSaver®                                        |                  |
|                          |                                     | OptoHiT™                                        |                  |
|                          |                                     | OPTOLOGIC®                                      |                  |
|                          |                                     | OPTOPLANAR®                                     |                  |
|                          |                                     | PowerTrench®                                    |                  |
|                          |                                     | PowerXS™                                        |                  |
|                          |                                     | Programmable Active Droop™                      |                  |
|                          |                                     | QFET®                                           |                  |
|                          |                                     | QS™                                             |                  |
|                          |                                     | Quiet Series™                                   |                  |
|                          |                                     | RapidConfigure™                                 |                  |
|                          |                                     | ISOPLANAR™                                      |                  |
|                          |                                     | Marking Small Speakers Sound Louder and Better™ |                  |
|                          |                                     | MegaBuck™                                       |                  |
|                          |                                     | MICROCOUPLER™                                   |                  |
|                          |                                     | MicroFET™                                       |                  |
|                          |                                     | MicroPak™                                       |                  |
|                          |                                     | MicroPak2™                                      |                  |
|                          |                                     | MillerDrive™                                    |                  |
|                          |                                     | MotionMax™                                      |                  |
|                          |                                     | mWSaver®                                        |                  |
|                          |                                     | OptoHiT™                                        |                  |
|                          |                                     | OPTOLOGIC®                                      |                  |
|                          |                                     | OPTOPLANAR®                                     |                  |
|                          |                                     | PowerTrench®                                    |                  |
|                          |                                     | PowerXS™                                        |                  |
|                          |                                     | Programmable Active Droop™                      |                  |
|                          |                                     | QFET®                                           |                  |
|                          |                                     | QS™                                             |                  |
|                          |                                     | Quiet Series™                                   |                  |
|                          |                                     | RapidConfigure™                                 |                  |
|                          |                                     | ISOPLANAR™                                      |                  |
|                          |                                     | Marking Small Speakers Sound Louder and Better™ |                  |
|                          |                                     | MegaBuck™                                       |                  |
|                          |                                     | MICROCOUPLER™                                   |                  |
|                          |                                     | MicroFET™                                       |                  |
|                          |                                     | MicroPak™                                       |                  |
|                          |                                     | MicroPak2™                                      |                  |
|                          |                                     | MillerDrive™                                    |                  |
|                          |                                     | MotionMax™                                      |                  |
|                          |                                     | mWSaver®                                        |                  |
|                          |                                     | OptoHiT™                                        |                  |
|                          |                                     | OPTOLOGIC®                                      |                  |
|                          |                                     | OPTOPLANAR®                                     |                  |
|                          |                                     | PowerTrench®                                    |                  |
|                          |                                     | PowerXS™                                        |                  |
|                          |                                     | Programmable Active Droop™                      |                  |
|                          |                                     | QFET®                                           |                  |
|                          |                                     | QS™                                             |                  |
|                          |                                     | Quiet Series™                                   |                  |
|                          |                                     | RapidConfigure™                                 |                  |
|                          |                                     | ISOPLANAR™                                      |                  |
|                          |                                     | Marking Small Speakers Sound Louder and Better™ |                  |
|                          |                                     | MegaBuck™                                       |                  |
|                          |                                     | MICROCOUPLER™                                   |                  |
|                          |                                     | MicroFET™                                       |                  |
|                          |                                     | MicroPak™                                       |                  |
|                          |                                     | MicroPak2™                                      |                  |
|                          |                                     | MillerDrive™                                    |                  |
|                          |                                     | MotionMax™                                      |                  |
|                          |                                     | mWSaver®                                        |                  |
|                          |                                     | OptoHiT™                                        |                  |
|                          |                                     | OPTOLOGIC®                                      |                  |
|                          |                                     | OPTOPLANAR®                                     |                  |
|                          |                                     | PowerTrench®                                    |                  |
|                          |                                     | PowerXS™                                        |                  |
|                          |                                     | Programmable Active Droop™                      |                  |
|                          |                                     | QFET®                                           |                  |
|                          |                                     | QS™                                             |                  |
|                          |                                     | Quiet Series™                                   |                  |
|                          |                                     | RapidConfigure™                                 |                  |
|                          |                                     |                                                 |                  |

# Mouser Electronics

Authorized Distributor

Click to View Pricing, Inventory, Delivery & Lifecycle Information:

[Fairchild Semiconductor:](#)

[FDP032N08B\\_F102](#)