

FDT458P

30V P-Channel PowerTrench[®] MOSFET

General Description

This P-Channel MOSFET has been designed specifically to improve the overall efficiency of DC/DC converters using either synchronous or conventional switching PWM controllers, and battery chargers.

These MOSFETs feature faster switching and lower gate charge than other MOSFETs with comparable $R_{DS(ON)}$ specifications.

Applications

- Battery chargers
- Motor drives

Features

- 3.4 A, -30 V. $R_{DS(ON)} = 130\text{ m}\Omega @ V_{GS} = 10\text{ V}$
 $R_{DS(ON)} = 200\text{ m}\Omega @ V_{GS} = 4.5\text{ V}$
- Fast switching speed
- Low gate charge (2.5 nC typical)
- High performance trench technology for extremely low $R_{DS(ON)}$
- High power and current handling capability in a widely used surface mount package



Absolute Maximum Ratings T_A=25°C unless otherwise noted

Symbol	Parameter	Ratings	Units
V_{DSS}	Drain-Source Voltage	- 30	V
V_{GSS}	Gate-Source Voltage	± 20	V
I_D	Drain Current – Continuous (Note 1a) – Pulsed	3.4	A
		10	
P_D	Maximum Power Dissipation (Note 1a) (Note 1b) (Note 1c)	3.0	W
		1.3	
		1.1	
T_J, T_{STG}	Operating and Storage Junction Temperature Range	-55 to +150	°C

Thermal Characteristics

$R_{\theta JA}$	Thermal Resistance, Junction-to-Ambient (Note 1a)	42	°C/W
$R_{\theta JC}$	Thermal Resistance, Junction-to-Case (Note 1)	12	°C/W

Package Marking and Ordering Information

Device Marking	Device	Reel Size	Tape width	Quantity
458P	FDT458P	13"	12mm	2500 units

Electrical Characteristics

$T_A = 25^\circ\text{C}$ unless otherwise noted

Symbol	Parameter	Test Conditions	Min	Typ	Max	Units
--------	-----------	-----------------	-----	-----	-----	-------

Off Characteristics

BV_{DSS}	Drain–Source Breakdown Voltage	$V_{GS} = 0\text{ V}, I_b = -250\ \mu\text{A}$	-30			V
$\frac{\Delta BV_{DSS}}{\Delta T_J}$	Breakdown Voltage Temperature Coefficient	$I_b = -250\ \mu\text{A}$, Referenced to 25°C		-23		mV/ $^\circ\text{C}$
I_{BSS}	Zero Gate Voltage Drain Current	$V_{DS} = -24\text{ V}, V_{GS} = 0\text{ V}$			-1	μA
I_{GSSF}	Gate–Body Leakage, Forward	$V_{GS} = -25\text{ V}, V_{DS} = 0\text{ V}$			100	nA
I_{GSSR}	Gate–Body Leakage, Reverse	$V_{GS} = -25\text{ V}, V_{DS} = 0\text{ V}$			-100	nA

On Characteristics (Note 2)

$V_{GS(th)}$	Gate Threshold Voltage	$V_{DS} = V_{GS}, I_b = -250\ \mu\text{A}$	-1	-1.8	-3	V
$\frac{\Delta V_{GS(th)}}{\Delta T_J}$	Gate Threshold Voltage Temperature Coefficient	$I_b = -250\ \mu\text{A}$, Referenced to 25°C		4		mV/ $^\circ\text{C}$
$R_{DS(on)}$	Static Drain–Source On–Resistance	$V_{GS} = -10\text{ V}, I_b = -3.4\text{ A}$ $V_{GS} = -4.5\text{ V}, I_b = -2.7\text{ A}$ $V_{GS} = -10\text{ V}, I_b = -3.4\text{ A}, T_J = 125^\circ\text{C}$		105 157 147	130 200 210	m Ω
$I_{D(on)}$	On–State Drain Current	$V_{GS} = -10\text{ V}, V_{DS} = -5\text{ V}$	-5			A
g_{FS}	Forward Transconductance	$V_{DS} = -5\text{ V}, I_b = -3.4\text{ A}$		3		S

Dynamic Characteristics

C_{iss}	Input Capacitance	$V_{DS} = -15\text{ V}, V_{GS} = 0\text{ V},$ $f = 1.0\text{ MHz}$		205		pF
C_{oss}	Output Capacitance			55		pF
C_{rss}	Reverse Transfer Capacitance			26		pF

Switching Characteristics (Note 2)

$t_{d(on)}$	Turn–On Delay Time	$V_{DD} = -15\text{ V}, I_b = -1\text{ A},$ $V_{GS} = -10\text{ V}, R_{GEN} = 6\ \Omega$		4.5	9	ns
t_r	Turn–On Rise Time			12.5	23	ns
$t_{d(off)}$	Turn–Off Delay Time			11	20	ns
t_f	Turn–Off Fall Time			2	4	ns
Q_g	Total Gate Charge	$V_{DS} = -15\text{ V}, I_b = -3.4\text{ A},$ $V_{GS} = -10\text{ V}$		2.5	3.5	nC
Q_{gs}	Gate–Source Charge			0.7		nC
Q_{gd}	Gate–Drain Charge			1		nC

Drain–Source Diode Characteristics and Maximum Ratings

I_S	Maximum Continuous Drain–Source Diode Forward Current				-2.5	A
V_{SD}	Drain–Source Diode Forward Voltage	$V_{GS} = 0\text{ V}, I_S = -2.5\text{ A}$ (Note 2)		-0.8	-1.2	V

Notes:

- $R_{\theta JA}$ is the sum of the junction-to-case and case-to-ambient thermal resistance where the case thermal reference is defined as the solder mounting surface of the drain pins. $R_{\theta JC}$ is guaranteed by design while $R_{\theta CA}$ is determined by the user's board design.

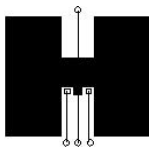

a) 42°C/W when mounted on a 1 in^2 pad of 2 oz copper



b) 95°C/W when mounted on a $.0066\text{ in}^2$ pad of 2 oz copper



c) 110°C/W when mounted on a minimum pad.

- Pulse Test: Pulse Width < 300 μs , Duty Cycle < 2.0%

Typical Characteristics

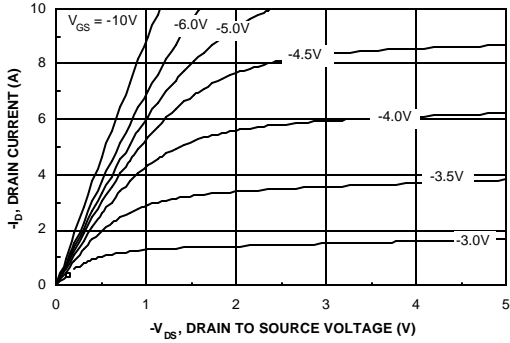

Figure 1. On-Region Characteristics.

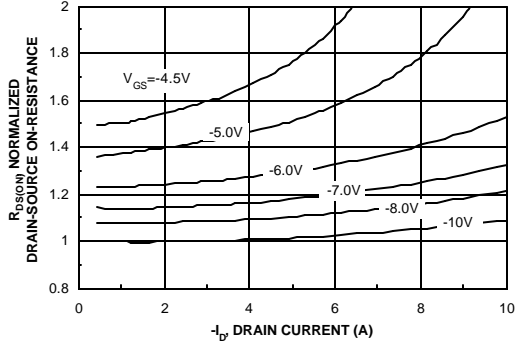

Figure 2. On-Resistance Variation with Drain Current and Gate Voltage.

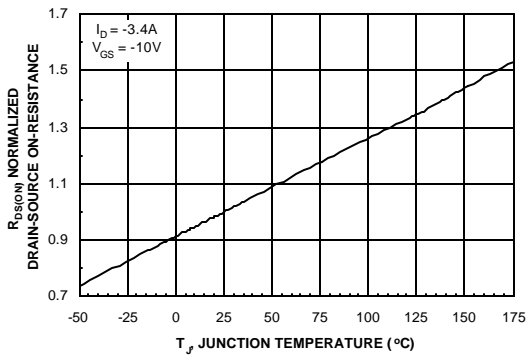

Figure 3. On-Resistance Variation with Temperature.

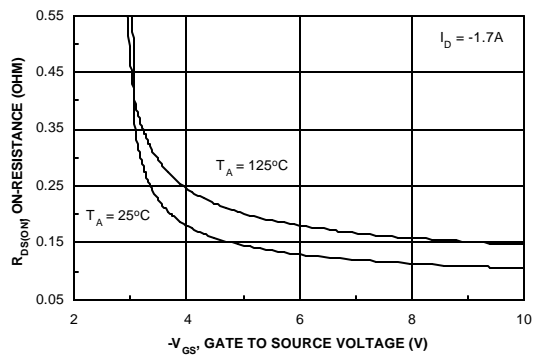

Figure 4. On-Resistance Variation with Gate-to-Source Voltage.

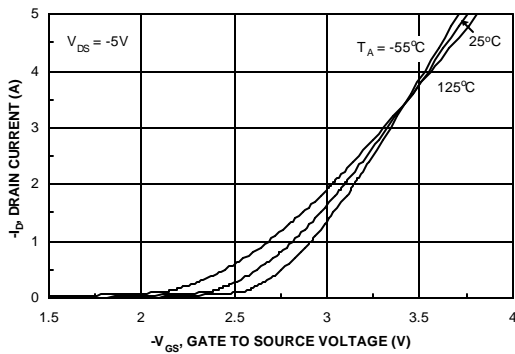

Figure 5. Transfer Characteristics.

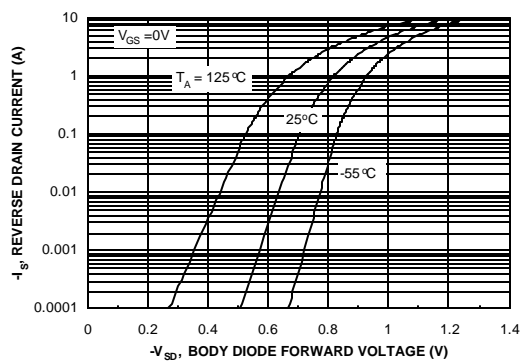

Figure 6. Body Diode Forward Voltage Variation with Source Current and Temperature.

Typical Characteristics

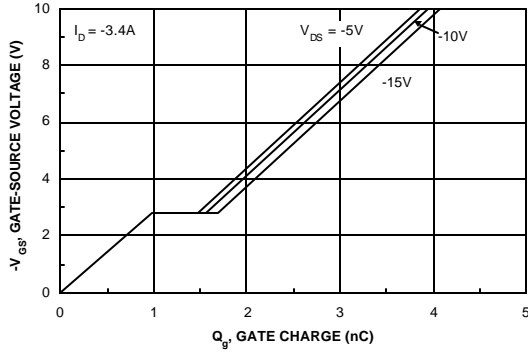

Figure 7. Gate Charge Characteristics.

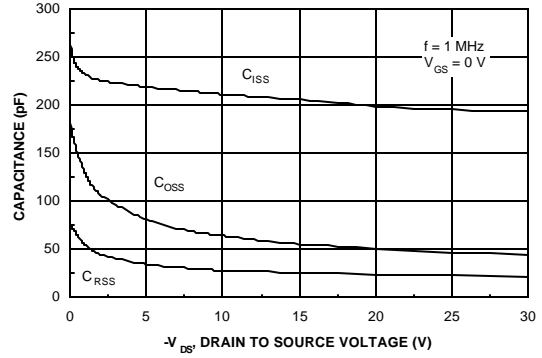

Figure 8. Capacitance Characteristics.

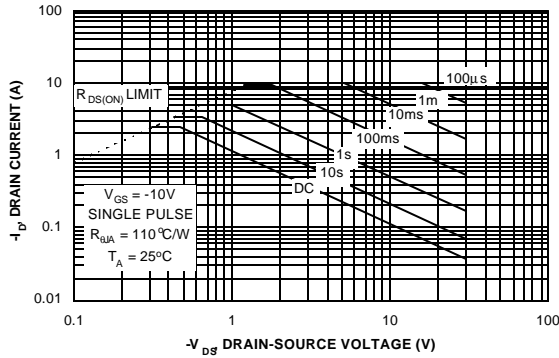

Figure 9. Maximum Safe Operating Area.

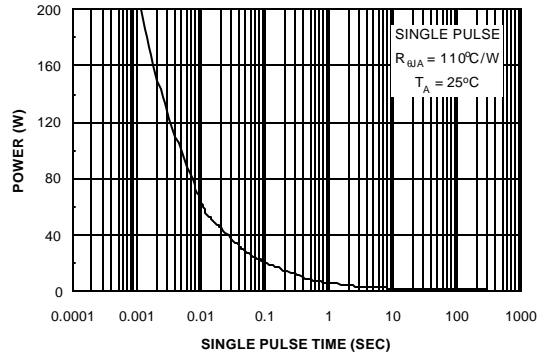

Figure 10. Single Pulse Maximum Power Dissipation.

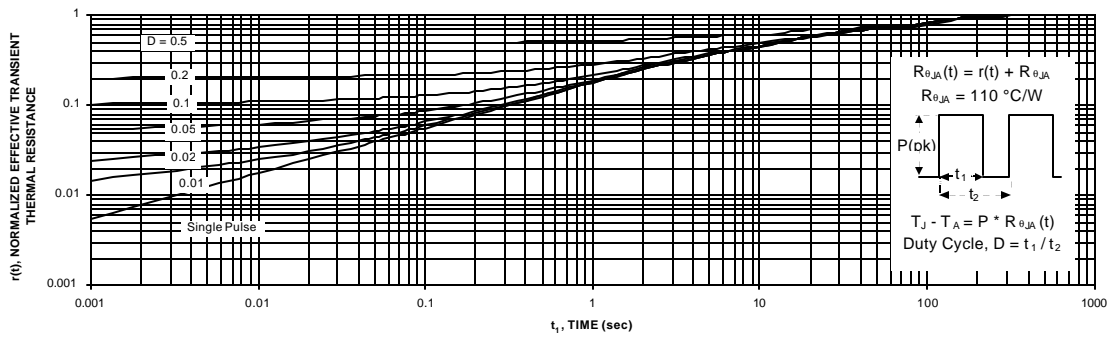
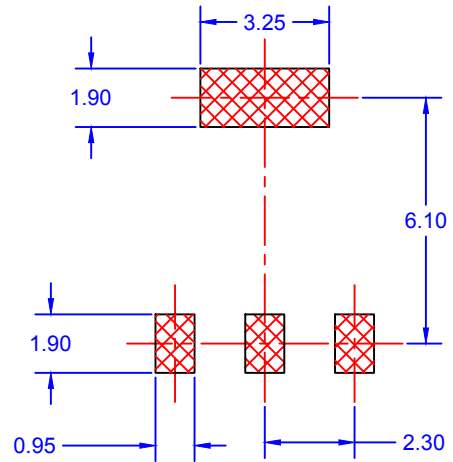
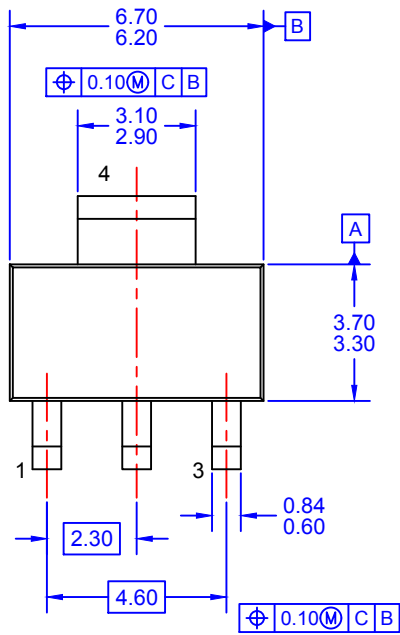
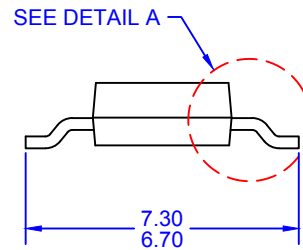
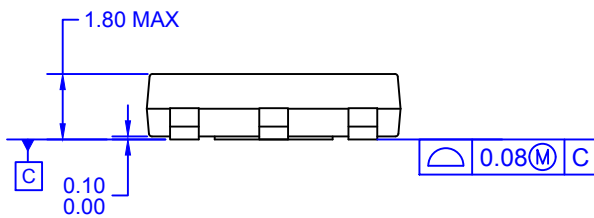

Figure 11. Transient Thermal Response Curve.

Thermal characterization performed using the conditions described in Note 1c.
 Transient thermal response will change depending on the circuit board design.



LAND PATTERN RECOMMENDATION



- NOTES: UNLESS OTHERWISE SPECIFIED
 A) DRAWING BASED ON JEDEC REGISTRATION TO-261C, VARIATION AA.
 B) ALL DIMENSIONS ARE IN MILLIMETERS.
 C) DIMENSIONS DO NOT INCLUDE BURRS OR MOLD FLASH. MOLD FLASH OR BURRS DOES NOT EXCEED 0.10MM.
 D) DIMENSIONING AND TOLERANCING PER ASME Y14.5M-2009.
 E) LANDPATTERN NAME: SOT230P700X180-4BN
 F) DRAWING FILENAME: MKT-MA04AREV3

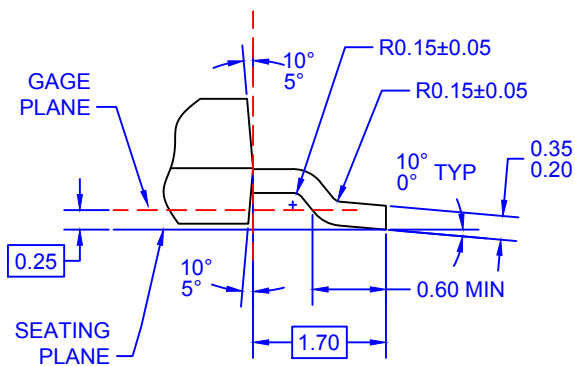

DETAIL A
 SCALE: 2:1





TRADEMARKS

The following includes registered and unregistered trademarks and service marks, owned by Fairchild Semiconductor and/or its global subsidiaries, and is not intended to be an exhaustive list of all such trademarks.

- | | | | |
|--------------------------|--|---------------------------------------|------------------|
| AccuPower™ | F-PFS™ | OPTOPLANAR® | SYSTEM GENERAL® |
| AttitudeEngine™ | FRFET® | Power Supply WebDesigner™ | TinyBoost® |
| Awinda® | Global Power Resource SM | PowerTrench® | TinyBuck® |
| AX-CAP®* | GreenBridge™ | PowerXS™ | TinyCalc™ |
| BitSiC™ | Green FPS™ | Programmable Active Droop™ | TinyLogic® |
| Build it Now™ | Green FPS™ e-Series™ | QFET® | TINYOPTO™ |
| CorePLUS™ | Gmax™ | QS™ | TinyPower™ |
| CorePOWER™ | GTO™ | Quiet Series™ | TinyPWM™ |
| CROSSVOL™ | IntelliMAX™ | RapidConfigure™ | TinyWire™ |
| CTL™ | ISOPLANAR™ | Saving our world, 1mW/W/kW at a time™ | TranSiC™ |
| Current Transfer Logic™ | Making Small Speakers Sound Louder and Better™ | SignalWise™ | TriFault Detect™ |
| DEUXPEED® | MegaBuck™ | SmartMax™ | TRUECURRENT®* |
| Dual Cool™ | MICROCOUPLER™ | SMART START™ | μSerDes™ |
| EcoSPARK® | MicroFET™ | Solutions for Your Success™ | UHC® |
| EfficientMax™ | MicroPak™ | SPM® | Ultra FRFET™ |
| ESBC™ | MicroPak2™ | STEALTH™ | UniFET™ |
| F [®] | MillerDrive™ | SuperFET® | Vcx™ |
| Fairchild® | MotionMax™ | SuperSOT™-3 | VisualMax™ |
| Fairchild Semiconductor® | MotionGrid® | SuperSOT™-6 | VoltagePlus™ |
| FACT Quiet Series™ | MTi® | SuperSOT™-8 | Xs™ |
| FACT® | MTx® | SupreMOS® | Xsens™ |
| FastvCore™ | MVN® | SyncFET™ | 仙童® |
| FETBench™ | mWSaver® | Sync-Lock™ | |
| FPS™ | OptoHiT™ | | |
| | OPTOLOGIC® | | |

* Trademarks of System General Corporation, used under license by Fairchild Semiconductor.

DISCLAIMER

FAIRCHILD SEMICONDUCTOR RESERVES THE RIGHT TO MAKE CHANGES WITHOUT FURTHER NOTICE TO ANY PRODUCTS HEREIN TO IMPROVE RELIABILITY, FUNCTION, OR DESIGN. TO OBTAIN THE LATEST, MOST UP-TO-DATE DATASHEET AND PRODUCT INFORMATION, VISIT OUR WEBSITE AT [HTTP://WWW.FAIRCHILDSEMI.COM](http://www.fairchildsemi.com). FAIRCHILD DOES NOT ASSUME ANY LIABILITY ARISING OUT OF THE APPLICATION OR USE OF ANY PRODUCT OR CIRCUIT DESCRIBED HEREIN; NEITHER DOES IT CONVEY ANY LICENSE UNDER ITS PATENT RIGHTS, NOR THE RIGHTS OF OTHERS. THESE SPECIFICATIONS DO NOT EXPAND THE TERMS OF FAIRCHILD'S WORLDWIDE TERMS AND CONDITIONS, SPECIFICALLY THE WARRANTY THEREIN, WHICH COVERS THESE PRODUCTS.

AUTHORIZED USE

Unless otherwise specified in this data sheet, this product is a standard commercial product and is not intended for use in applications that require extraordinary levels of quality and reliability. This product may not be used in the following applications, unless specifically approved in writing by a Fairchild officer: (1) automotive or other transportation, (2) military/aerospace, (3) any safety critical application – including life critical medical equipment – where the failure of the Fairchild product reasonably would be expected to result in personal injury, death or property damage. Customer's use of this product is subject to agreement of this Authorized Use policy. In the event of an unauthorized use of Fairchild's product, Fairchild accepts no liability in the event of product failure. In other respects, this product shall be subject to Fairchild's Worldwide Terms and Conditions of Sale, unless a separate agreement has been signed by both Parties.

ANTI-COUNTERFEITING POLICY

Fairchild Semiconductor Corporation's Anti-Counterfeiting Policy. Fairchild's Anti-Counterfeiting Policy is also stated on our external website, www.fairchildsemi.com, under Terms of Use

Counterfeiting of semiconductor parts is a growing problem in the industry. All manufacturers of semiconductor products are experiencing counterfeiting of their parts. Customers who inadvertently purchase counterfeit parts experience many problems such as loss of brand reputation, substandard performance, failed applications, and increased cost of production and manufacturing delays. Fairchild is taking strong measures to protect ourselves and our customers from the proliferation of counterfeit parts. Fairchild strongly encourages customers to purchase Fairchild parts either directly from Fairchild or from Authorized Fairchild Distributors who are listed by country on our web page cited above. Products customers buy either from Fairchild directly or from Authorized Fairchild Distributors are genuine parts, have full traceability, meet Fairchild's quality standards for handling and storage and provide access to Fairchild's full range of up-to-date technical and product information. Fairchild and our Authorized Distributors will stand behind all warranties and will appropriately address any warranty issues that may arise. Fairchild will not provide any warranty coverage or other assistance for parts bought from Unauthorized Sources. Fairchild is committed to combat this global problem and encourage our customers to do their part in stopping this practice by buying direct or from authorized distributors.

PRODUCT STATUS DEFINITIONS

Definition of Terms

Datasheet Identification	Product Status	Definition
Advance Information	Formative / In Design	Datasheet contains the design specifications for product development. Specifications may change in any manner without notice.
Preliminary	First Production	Datasheet contains preliminary data; supplementary data will be published at a later date. Fairchild Semiconductor reserves the right to make changes at any time without notice to improve design.
No Identification Needed	Full Production	Datasheet contains final specifications. Fairchild Semiconductor reserves the right to make changes at any time without notice to improve the design.
Obsolete	Not In Production	Datasheet contains specifications on a product that is discontinued by Fairchild Semiconductor. The datasheet is for reference information only.

Mouser Electronics

Authorized Distributor

Click to View Pricing, Inventory, Delivery & Lifecycle Information:

[Fairchild Semiconductor:](#)

[FDT458P](#)