



Is Now Part of



ON Semiconductor®

To learn more about ON Semiconductor, please visit our website at
www.onsemi.com

ON Semiconductor and the ON Semiconductor logo are trademarks of Semiconductor Components Industries, LLC dba ON Semiconductor or its subsidiaries in the United States and/or other countries. ON Semiconductor owns the rights to a number of patents, trademarks, copyrights, trade secrets, and other intellectual property. A listing of ON Semiconductor's product/patent coverage may be accessed at www.onsemi.com/site/pdf/Patent-Marking.pdf. ON Semiconductor reserves the right to make changes without further notice to any products herein. ON Semiconductor makes no warranty, representation or guarantee regarding the suitability of its products for any particular purpose, nor does ON Semiconductor assume any liability arising out of the application or use of any product or circuit, and specifically disclaims any and all liability, including without limitation special, consequential or incidental damages. Buyer is responsible for its products and applications using ON Semiconductor products, including compliance with all laws, regulations and safety requirements or standards, regardless of any support or applications information provided by ON Semiconductor. "Typical" parameters which may be provided in ON Semiconductor data sheets and/or specifications can and do vary in different applications and actual performance may vary over time. All operating parameters, including "Typicals" must be validated for each customer application by customer's technical experts. ON Semiconductor does not convey any license under its patent rights nor the rights of others. ON Semiconductor products are not designed, intended, or authorized for use as a critical component in life support systems or any FDA Class 3 medical devices or medical devices with a same or similar classification in a foreign jurisdiction or any devices intended for implantation in the human body. Should Buyer purchase or use ON Semiconductor products for any such unintended or unauthorized application, Buyer shall indemnify and hold ON Semiconductor and its officers, employees, subsidiaries, affiliates, and distributors harmless against all claims, costs, damages, and expenses, and reasonable attorney fees arising out of, directly or indirectly, any claim of personal injury or death associated with such unintended or unauthorized use, even if such claim alleges that ON Semiconductor was negligent regarding the design or manufacture of the part. ON Semiconductor is an Equal Opportunity/Affirmative Action Employer. This literature is subject to all applicable copyright laws and is not for resale in any manner.



FPF1203 / FPF1203L / FPF1204 / FPF12045

IntelliMAX™ Ultra-Small, Slew-Rate-Controlled Load Switch

Features

- 1.2 V to 5.5 V Input Voltage Operating Range
- Typical R_{ON} :
 - 45 m Ω at $V_{IN}=5.5$ V
 - 55 m Ω at $V_{IN}=3.3$ V
 - 90 m Ω at $V_{IN}=1.8$ V
 - 185 m Ω at $V_{IN}=1.2$ V
- Slew Rate Control with t_R :
 - FPF1203/FPF1203L/FPF1204: 100 μ s
 - FPF12045: 2 μ s
- Output Discharge Function on FPF1204 / 45
- Low <1.5 μ A Quiescent Current
- ESD Protected: Above 7 kV HBM, 2 kV CDM
- GPIO / CMOS-Compatible Enable Circuitry
- 4-Bump, WLCSP 0.76 mm x 0.76 mm, 0.4 mm Pitch

Description

The FPF1203 / 03L / 04 / 45 are ultra-small integrated IntelliMAX™ load switches with integrated P-channel switch and analog control features. Integrated slew-rate control prevents inrush current and the resulting excessive voltage drop on the power rail. The input voltage range operates from 1.2 V to 5.5 V to provide power-disconnect capability for post-regulated power rails in portable and consumer products. The low shut-off current allows power designs to meet standby and off-power drain specifications.

The FPF120x are controlled by a logic input (ON pin) compatible with standard CMOS GPIO circuitry found on Field Programmable Gate Array (FPGA) embedded processors. The FPF120x are available in 0.76 mm x 0.76 mm 4-bump WLCSP.

Applications

- Mobile Devices and Smart Phones
- Portable Media Devices
- Tablet PCs
- Advanced Notebook, UMPC, MID
- Portable Medical Devices
- GPS and Navigation Equipment

Ordering Information

Part Number	Top Mark	Switch (Typical) at 3.3V _{IN}	Output Discharge	ON Pin Activity	t _R	Package
FPF1203UCX	QL	55 m Ω	NA	Active HIGH	100 μ s	4-Bump, Wafer-Level Chip-Scale Package (WLCSP), 0.76 mm x 0.76 mm, 0.4 mm Pitch
FPF1203LUCX	QP	55 m Ω	NA	Active LOW	100 μ s	
FPF1204UCX	QM	55 m Ω	65 Ω	Active HIGH	100 μ s	
FPF1204UCX_F013 (Amkor Assembly Only)	QM	55 m Ω	65 Ω	Active HIGH	100 μ s	
FPF1204BUCX (Backside Laminate)	QM	55 m Ω	65 Ω	Active HIGH	100 μ s	
FPF12045UCX	NC	55 m Ω	65 Ω	Active HIGH	2 μ s	

FPF1203 / FPF1203L / FPF1204 / FPF12045 — IntelliMAX™ Ultra-Small, Slew-Rate-Controlled Load Switch

Application Diagram

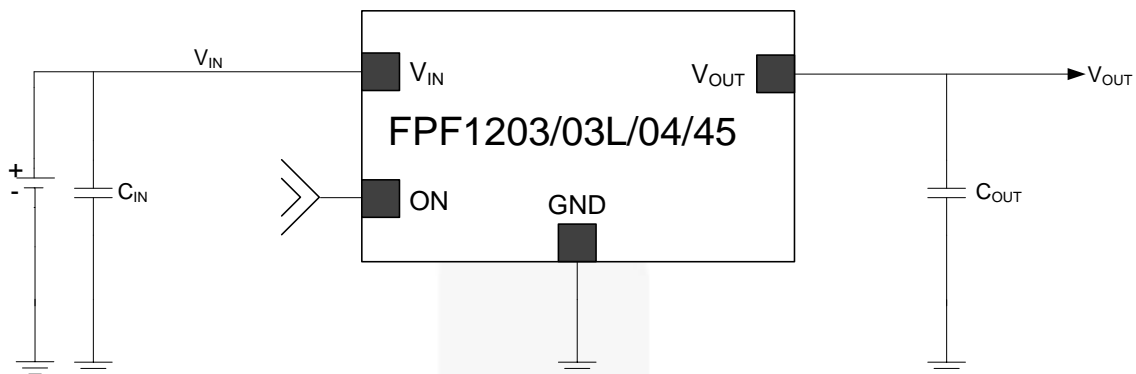

Figure 1. Typical Application

Functional Block Diagram

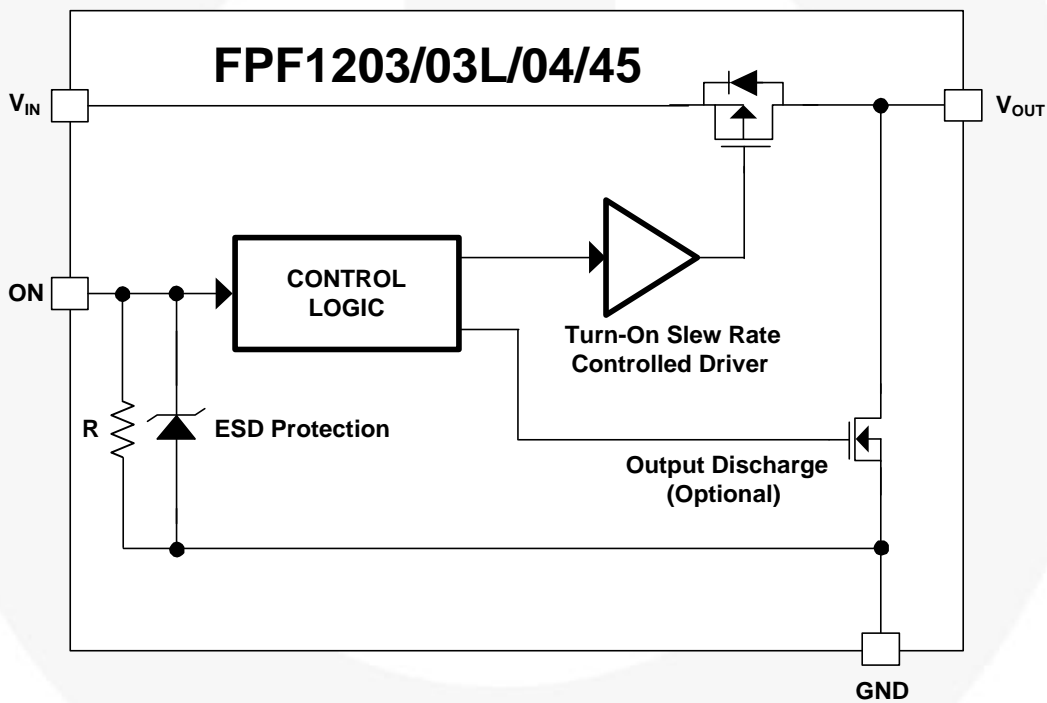

Figure 2. Functional Block Diagram (Output Discharge for FPF1204 / 45)

Pin Configurations

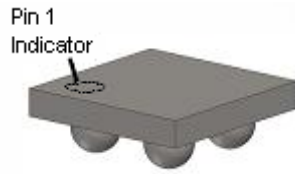

Figure 3. WLCSP Bumps Facing Down (Top View)

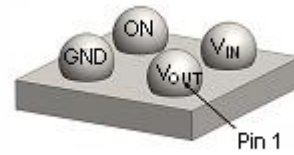

Figure 4. WLCSP Bumps Facing Up (Bottom View)

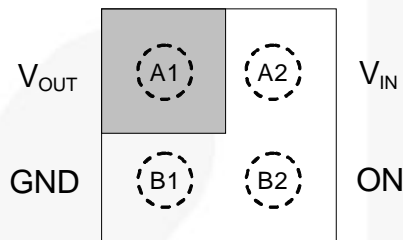

Figure 5. Pin Assignments (Top View)

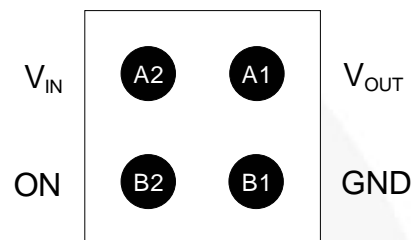

Figure 6. Pin Assignments (Bottom View)

Pin Definitions

Pin #	Name	Description
A1	V_{OUT}	Switch output
A2	V_{IN}	Supply input: input to the power switch
B1	GND	Ground
B2	ON	ON/OFF Control, active HIGH; FPF1203/04/45
B2	ON	ON/OFF Control, active LOW; FPF1203L

Absolute Maximum Ratings

Stresses exceeding the absolute maximum ratings may damage the device. The device may not function or be operable above the recommended operating conditions and stressing the parts to these levels is not recommended. In addition, extended exposure to stresses above the recommended operating conditions may affect device reliability. The absolute maximum ratings are stress ratings only.

Symbol	Parameter	Min.	Max.	Unit
V_{IN}	V_{IN} , V_{OUT} , V_{ON} to GND	-0.3	6.0	V
I_{SW}	Maximum Continuous Switch Current at Ambient Operating Temperature		2.2	A
P_D	Power Dissipation at $T_A=25^\circ\text{C}$		1.0	W
T_{STG}	Storage Temperature Range	-65	+150	$^\circ\text{C}$
Θ_{JA}	Thermal Resistance, Junction-to-Ambient	1S2P with One Thermal Via ⁽¹⁾	110	$^\circ\text{C/W}$
		1S2P without Thermal Via ⁽²⁾	95	
ESD	Electrostatic Discharge Capability ^(1,2)	Human Body Model, JESD22-A114	7	kV
		Charged Device Model, JESD22-C101	2	

Notes:

1. Measured using 2S2P JEDEC std. PCB.
2. Measured using 2S2P JEDEC PCB COLD PLATE Method.

Recommended Operating Conditions

The Recommended Operating Conditions table defines the conditions for actual device operation. Recommended operating conditions are specified to ensure optimal performance to the datasheet specifications. Fairchild does not recommend exceeding them or designing to Absolute Maximum Ratings.

Symbol	Parameter	Min.	Max.	Unit
V_{IN}	Input Voltage	1.2	5.5	V
T_A	Ambient Operating Temperature	-40	+85	$^\circ\text{C}$

Electrical Characteristics

Unless otherwise noted, $V_{IN}=1.2\text{ V}$ to 5.5 V and $T_A=-40$ to $+85^\circ\text{C}$. Typical values are at $V_{IN}=3.3\text{ V}$ and $T_A=25^\circ\text{C}$.

Symbol	Parameter	Condition	Min.	Typ.	Max.	Unit	
Basic Operation							
V_{IN}	Supply Voltage		1.2		5.5	V	
$I_{Q(OFF)}$	Off Supply Current	PPF1203/04/45	$V_{ON}=GND, V_{OUT}=Open, V_{IN}=5.5\text{ V}$		0.1	1.0	μA
		PPF1203L	$V_{ON}=V_{IN}, V_{OUT}=Open, V_{IN}=5.5\text{ V}$		1.0	2.0	
I_{SD}	Shutdown Current	PPF1203/04/45	$V_{ON}=GND, V_{OUT}=GND$		0.1	1.0	μA
		PPF1203L	$V_{ON}=V_{IN}, V_{OUT}=GND$		1.2	3.0	
I_Q	Quiescent Current	PPF1203/04/45	$I_{OUT}=0\text{ mA}, V_{ON}=V_{IN}, =5.5\text{ V}$		0.1	1.5	μA
		PPF1203L	$I_{OUT}=0\text{ mA}, V_{ON}=GND, V_{IN}, =5.5\text{ V}$				
R_{ON}	On Resistance		$V_{IN}=5.5\text{ V}, I_{OUT}=200\text{ mA}, T_A=25^\circ\text{C}$		45	55 ⁽³⁾	m Ω
			$V_{IN}=3.3\text{ V}, I_{OUT}=200\text{ mA}, T_A=25^\circ\text{C}$		55	65 ⁽³⁾	
			$V_{IN}=1.8\text{ V}, I_{OUT}=200\text{ mA}, T_A=25^\circ\text{C}$		90	100 ⁽³⁾	
			$V_{IN}=1.2\text{ V}, I_{OUT}=200\text{ mA}, T_A=25^\circ\text{C}$		185	220 ⁽³⁾	
			$V_{IN}=1.8\text{ V}, I_{OUT}=200\text{ mA}, T_A=85^\circ\text{C}$ ⁽³⁾			105	
R_{PD}	Output Discharge $R_{PULL\ DOWN}$	$V_{IN}=3.3\text{ V}, V_{ON}=OFF,$ $I_{FORCE}=20\text{ mA}, T_A=25^\circ\text{C},$ PPF1204 / PPF12045		65	75	Ω	
V_{IH}	On Input Logic HIGH Voltage	$V_{IN}=1.2\text{ V}$ to 5.5 V	1.15			V	
V_{IL}	On Input Logic LOW Voltage	$V_{IN}=1.2\text{ V}$ to 5.5 V			0.65	V	
R_{ON_PD}	Pull-Down Resistance at ON Pin	$V_{IN}=1.2\text{ V}$ to 5.5 V		8.3		M Ω	
I_{ON}	On Input Leakage	$V_{ON}=V_{IN}$ or GND			1	μA	
Dynamic Characteristics							
t_{DON}	Turn-On Delay ⁽⁴⁾	$V_{IN}=3.3\text{ V}, R_L=10\ \Omega, C_L=0.1\ \mu\text{F},$ $T_A=25^\circ\text{C}, \text{PPF12045}$		70		μs	
t_R	V_{OUT} Rise Time ⁽⁴⁾			100			
t_{ON}	Turn-On Time ⁽⁶⁾			170			
t_{DON}	Turn-On Delay ⁽⁴⁾			2			
t_R	V_{OUT} Rise Time ⁽⁴⁾			2			
t_{ON}	Turn-On Time ⁽⁶⁾			4			
t_{DOFF}	Turn-Off Delay ^(4,5)	$V_{IN}=3.3\text{ V}, R_L=10\ \Omega, C_L=0.1\ \mu\text{F},$ $T_A=25^\circ\text{C}, \text{PPF1203L}$		0.5		μs	
t_F	V_{OUT} Fall Time ^(4,5)			2.0			
t_{OFF}	Turn-Off Time ^(5,7)			2.5			
t_{DOFF}	Turn-Off Delay ^(4,5)	$V_{IN}=3.3\text{ V}, R_L=500\ \Omega, C_L=0.1\ \mu\text{F},$ $T_A=25^\circ\text{C}, \text{PPF1203L}$		6		μs	
t_F	V_{OUT} Fall Time ^(4,5)			115			
t_{OFF}	Turn-Off Time ^(5,7)			121			
t_{DOFF}	Turn-Off Delay ^(4,5)	$V_{IN}=3.3\text{ V}, R_L=10\ \Omega, C_L=0.1\ \mu\text{F},$ $T_A=25^\circ\text{C}, \text{PPF1203}$		4.0		μs	
t_F	V_{OUT} Fall Time ^(4,5)			2.9			
t_{OFF}	Turn-Off Time ^(5,7)			7.3			
t_{DOFF}	Turn-Off Delay ^(4,5)	$V_{IN}=3.3\text{ V}, R_L=500\ \Omega, C_L=0.1\ \mu\text{F},$ $T_A=25^\circ\text{C}, \text{PPF1203}$		6		μs	
t_F	V_{OUT} Fall Time ^(4,5)			115			
t_{OFF}	Turn-Off Time ^(5,7)			121			

Continued on the following page...

Electrical Characteristics

Unless otherwise noted, $V_{IN}=1.2\text{ V to }5.5\text{ V}$ and $T_A=-40\text{ to }+85^\circ\text{C}$. Typical values are at $V_{IN}=3.3\text{ V}$ and $T_A=25^\circ\text{C}$.

Symbol	Parameter	Condition	Min.	Typ.	Max.	Unit
t_{DOFF}	Turn-Off Delay ^(4,5)	$V_{IN}=3.3\text{ V}, R_L=10\ \Omega, C_L=0.1\ \mu\text{F}, T_A=25^\circ\text{C}, \text{FPF1204/45}^{(5)}$		4.0		μs
t_F	V_{OUT} Fall Time ^(4,5)			2.5		
t_{OFF}	Turn-Off Time ^(5,7)			6.5		
t_{DOFF}	Turn-Off Delay ^(4,5)	$V_{IN}=3.3\text{ V}, R_L=500\ \Omega, C_L=0.1\ \mu\text{F}, T_A=25^\circ\text{C}, \text{FPF1204/45}^{(5)}$		6		μs
t_F	V_{OUT} Fall Time ^(4,5)			11		
t_{OFF}	Turn-Off Time ^(5,7)			17		

Notes:

- This parameter is guaranteed by design and characterization; not production tested.
- $t_{DON}/t_{DOFF}/t_R/t_F$ are defined in Figure 23.
- Output discharge enabled during off-state.
- $t_{ON}=t_R + t_{DON}$.
- $t_{OFF}=t_F + t_{DOFF}$.

Typical Performance Characteristics

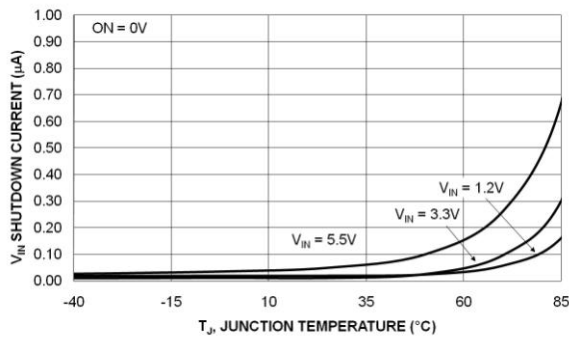

Figure 7. Shutdown Current vs. Temperature

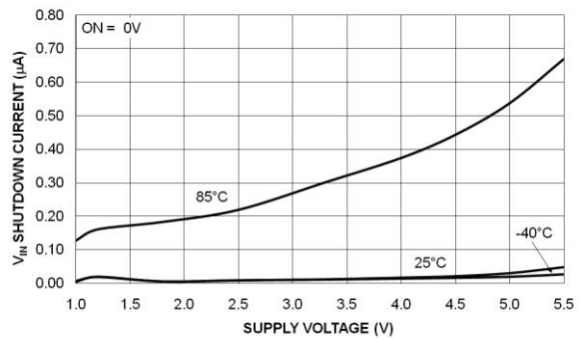

Figure 8. Shutdown Current vs. Supply Voltage

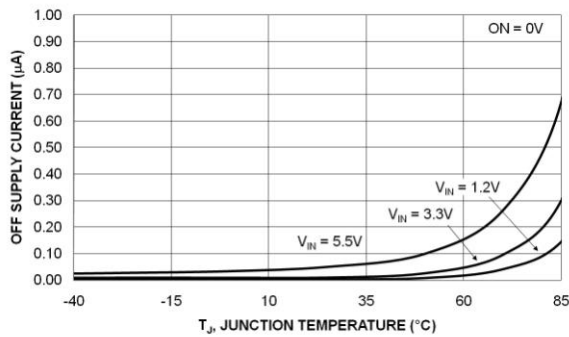

Figure 9. Off Supply Current vs. Temperature (V_{OUT} Floating)

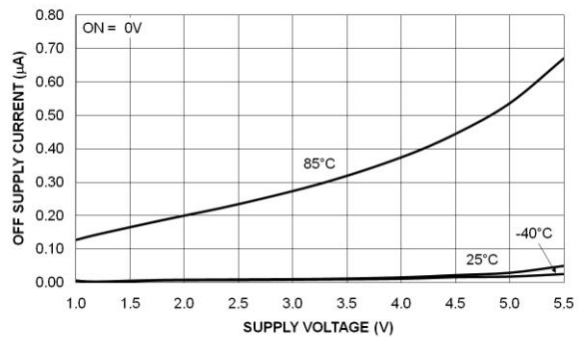

Figure 10. Off Supply Current vs. Supply Voltage (V_{OUT} Floating)

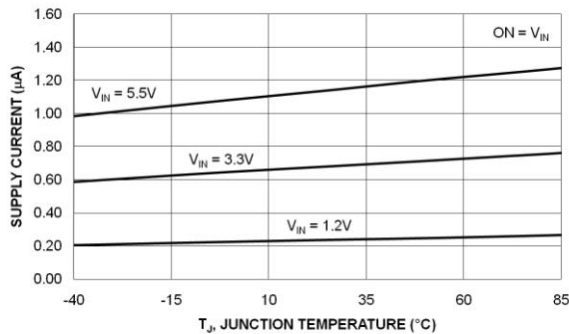

Figure 11. Quiescent Current vs. Temperature

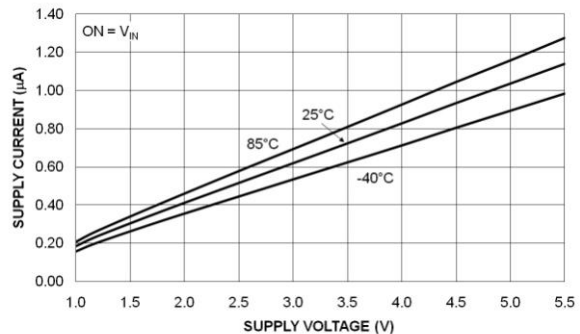

Figure 12. Quiescent Current vs. Supply Voltage

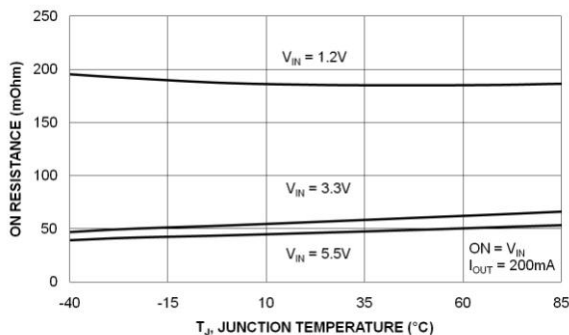

Figure 13. R_{ON} vs. Temperature

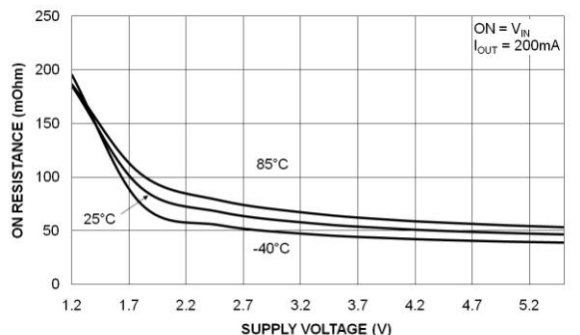

Figure 14. R_{ON} vs. Supply Voltage

Typical Performance Characteristics (Continued)

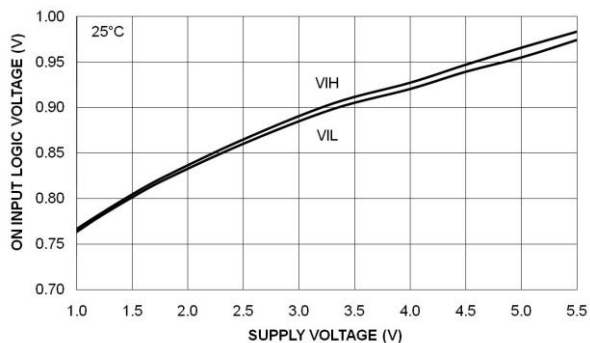

Figure 15. ON Pin Threshold vs. V_{IN}

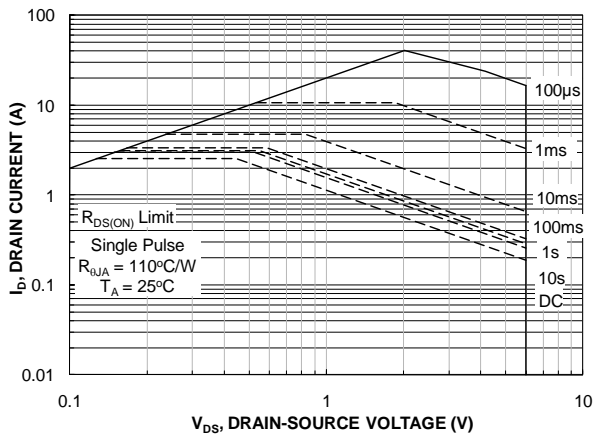

Figure 16. Drain Current vs. Drain-Source Voltage Safe Operating Area

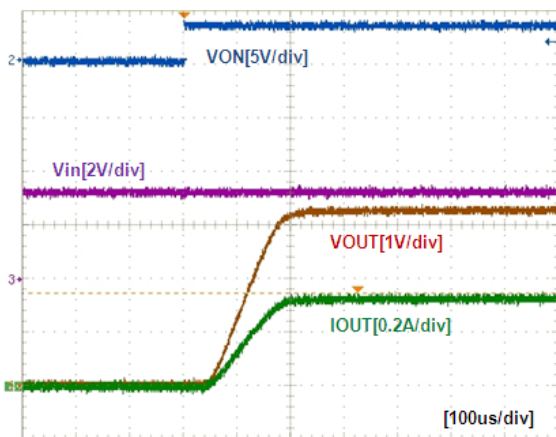

Figure 17. Turn-On Response – FPF1203 / 04 ($V_{IN}=3.3\text{ V}$, $C_{IN}=1\ \mu\text{F}$, $C_{OUT}=0.1\ \mu\text{F}$, $R_L=10\ \Omega$)

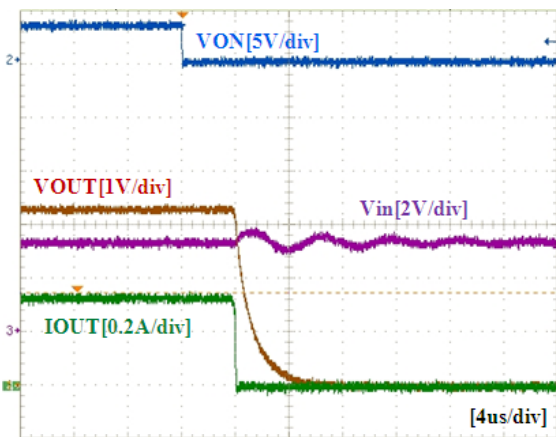

Figure 18. Turn-Off Response – FPF1203 ($V_{IN}=3.3\text{ V}$, $C_{IN}=1\ \mu\text{F}$, $C_{OUT}=0.1\ \mu\text{F}$, $R_L=10\ \Omega$)

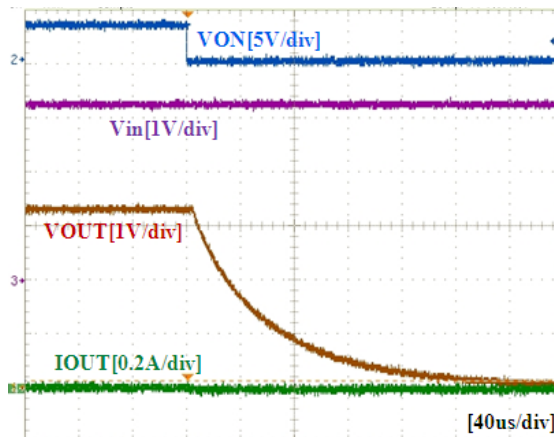

Figure 19. Turn-Off Response – FPF1203 ($V_{IN}=3.3\text{ V}$, $C_{IN}=1\ \mu\text{F}$, $C_{OUT}=0.1\ \mu\text{F}$, $R_L=500\ \Omega$)

Typical Performance Characteristics (Continued)

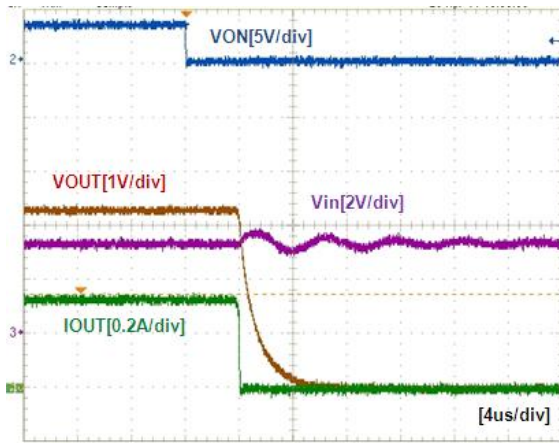

Figure 20. Turn-Off Response ($V_{IN}=3.3\text{ V}$, $C_{IN}=1\ \mu\text{F}$, $C_{OUT}=0.1\ \mu\text{F}$, $R_L=10\ \Omega$, FPF1204 / 45)

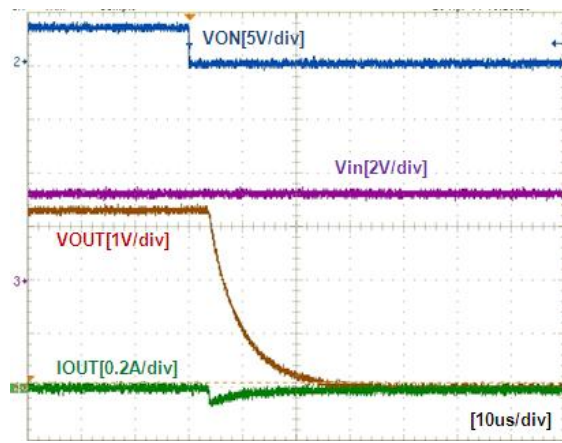

Figure 21. Turn-Off Response ($V_{IN}=3.3\text{ V}$, $C_{IN}=1\ \mu\text{F}$, $C_{OUT}=0.1\ \mu\text{F}$, $R_L=500\ \Omega$, FPF1204 / 45)

Operation and Application Description

The FPF1203 / 03L / 04 / 045 are low- R_{ON} P-channel load switches with controlled turn-on. The core of each device is a 55 m Ω P-channel MOSFET and controller capable of functioning over a wide input operating range of 1.2 to 5.5 V.

The FPF1204 / 45 contain a 65 Ω on-chip load resistor for quick output discharge when the switch is turned off.

The FPF12045 features a faster V_{OUT} Rise Time of 5 μ s.

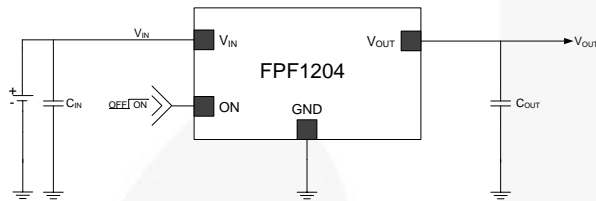

Figure 22. Typical Application

Input Capacitor

To limit the voltage drop on the input supply caused by transient inrush current when the switch turns on into a discharged load capacitor or short-circuit, a capacitor must be placed between the V_{IN} and GND pins. A 1 μ F ceramic capacitor, C_{IN} , placed close to the pins is usually sufficient. Higher-value C_{IN} can be used to reduce the voltage drop in higher-current applications.

Output Capacitor

A 0.1 μ F capacitor, C_{OUT} , should be placed between the V_{OUT} and GND pins. This capacitor prevents parasitic board inductance from forcing V_{OUT} below GND when the switch is on. C_{IN} greater than C_{OUT} is highly recommended. C_{OUT} greater than C_{IN} can cause V_{OUT} to exceed V_{IN} when the system supply is removed. This could result in current flow through the body diode from V_{OUT} to V_{IN} .

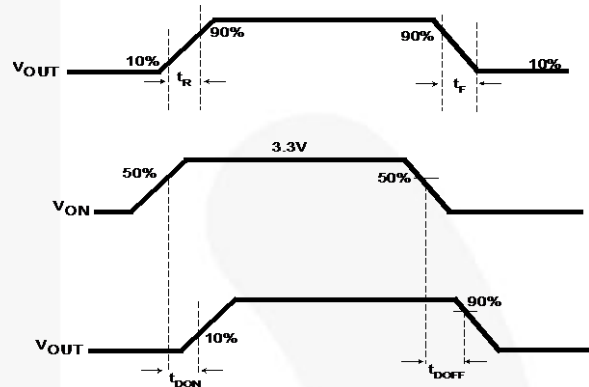

Figure 23. Timing Diagram for FPF1203/4/045

Board Layout

For best performance, traces should be as short as possible. To be most effective, input and output capacitors should be placed close to the device to minimize the effect of parasitic trace inductance on normal and short-circuit operation. Using wide traces or large copper planes for all pins (V_{IN} , V_{OUT} , ON, and GND) minimizes the parasitic electrical effects and the case-ambient thermal impedance. However, the V_{OUT} pin should not connect directly to the battery source due to the discharge mechanism of the load switch.

The table below pertains to the Packaging information on the following page.

Product Dimensions

D	E	X	Y
760 μ m \pm 30 μ m	760 μ m \pm 30 μ m	0.180 mm \pm 0.018 μ m	0.180 mm \pm 0.018 μ m

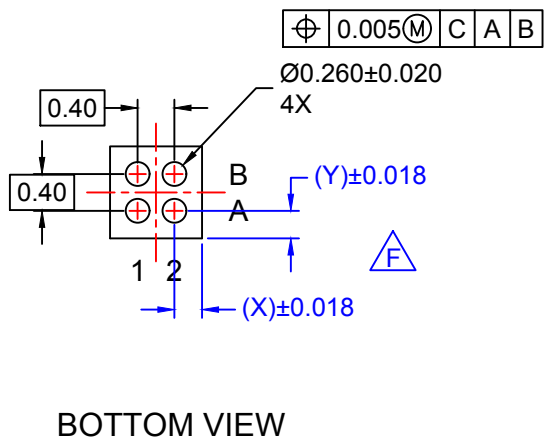
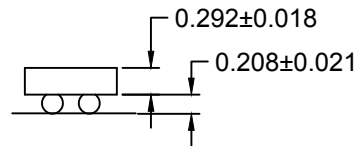
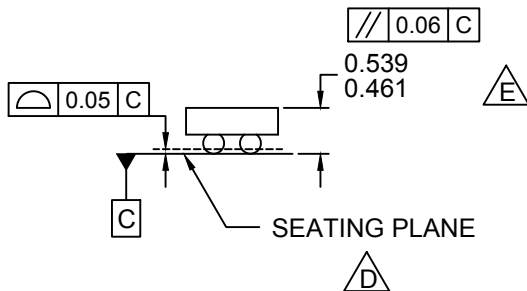
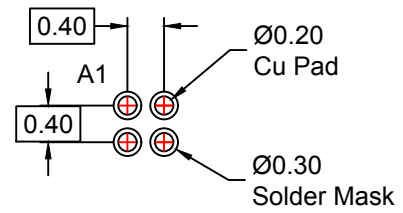
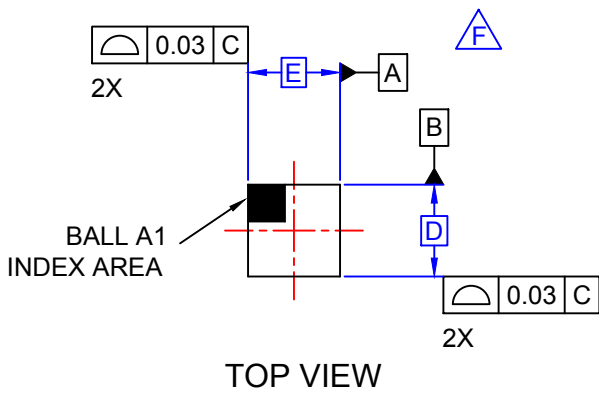

NOTES:

- A. NO JEDEC REGISTRATION APPLIES.
- B. DIMENSIONS ARE IN MILLIMETERS.
- C. DIMENSIONS AND TOLERANCE PER ASME Y14.5M, 1994.
- D. DATUM C IS DEFINED BY THE SPHERICAL CROWNS OF THE BALLS.
- E. PACKAGE NOMINAL HEIGHT IS 500 MICRONS ±39 MICRONS (461-539 MICRONS).
- F. FOR DIMENSIONS D, E, X, AND Y SEE PRODUCT DATASHEET.
- G. DRAWING FILNAME: MKT-UC004AFrev2.





TRADEMARKS

The following includes registered and unregistered trademarks and service marks, owned by Fairchild Semiconductor and/or its global subsidiaries, and is not intended to be an exhaustive list of all such trademarks.

- | | | | |
|--------------------------|--|---------------------------------------|------------------|
| AccuPower™ | F-PFS™ | OPTOPLANAR® | SYSTEM GENERAL® |
| AttitudeEngine™ | FRFET® | Power Supply WebDesigner™ | TinyBoost® |
| Awinda® | Global Power Resource SM | PowerTrench® | TinyBuck® |
| AX-CAP®* | GreenBridge™ | PowerXS™ | TinyCalc™ |
| BitSiC™ | Green FPS™ | Programmable Active Droop™ | TinyLogic® |
| Build it Now™ | Green FPS™ e-Series™ | QFET® | TINYOPTO™ |
| CorePLUS™ | Gmax™ | QS™ | TinyPower™ |
| CorePOWER™ | GTO™ | Quiet Series™ | TinyPWM™ |
| CROSSVOL™ | IntelliMAX™ | RapidConfigure™ | TinyWire™ |
| CTL™ | ISOPLANAR™ | Saving our world, 1mW/W/kW at a time™ | TranSiC™ |
| Current Transfer Logic™ | Making Small Speakers Sound Louder and Better™ | SignalWise™ | TriFault Detect™ |
| DEUXPEED® | MegaBuck™ | SmartMax™ | TRUECURRENT®* |
| Dual Cool™ | MICROCOUPLER™ | SMART START™ | μSerDes™ |
| EcoSPARK® | MicroFET™ | Solutions for Your Success™ | UHC® |
| EfficientMax™ | MicroPak™ | SPM® | Ultra FRFET™ |
| ESBC™ | MicroPak2™ | STEALTH™ | UniFET™ |
| F [®] | MillerDrive™ | SuperFET® | VCX™ |
| Fairchild® | MotionMax™ | SuperSOT™-3 | VisualMax™ |
| Fairchild Semiconductor® | MotionGrid® | SuperSOT™-6 | VoltagePlus™ |
| FACT Quiet Series™ | MTi® | SuperSOT™-8 | XST™ |
| FACT® | MTx® | SupreMOS® | Xsens™ |
| FastvCore™ | MVN® | SyncFET™ | 仙童® |
| FETBench™ | mWSaver® | Sync-Lock™ | |
| FPS™ | OptoHiT™ | | |
| | OPTOLOGIC® | | |

* Trademarks of System General Corporation, used under license by Fairchild Semiconductor.

DISCLAIMER

FAIRCHILD SEMICONDUCTOR RESERVES THE RIGHT TO MAKE CHANGES WITHOUT FURTHER NOTICE TO ANY PRODUCTS HEREIN TO IMPROVE RELIABILITY, FUNCTION, OR DESIGN. TO OBTAIN THE LATEST, MOST UP-TO-DATE DATASHEET AND PRODUCT INFORMATION, VISIT OUR WEBSITE AT [HTTP://WWW.FAIRCHILDSEMI.COM](http://www.fairchildsemi.com). FAIRCHILD DOES NOT ASSUME ANY LIABILITY ARISING OUT OF THE APPLICATION OR USE OF ANY PRODUCT OR CIRCUIT DESCRIBED HEREIN; NEITHER DOES IT CONVEY ANY LICENSE UNDER ITS PATENT RIGHTS, NOR THE RIGHTS OF OTHERS. THESE SPECIFICATIONS DO NOT EXPAND THE TERMS OF FAIRCHILD'S WORLDWIDE TERMS AND CONDITIONS, SPECIFICALLY THE WARRANTY THEREIN, WHICH COVERS THESE PRODUCTS.

AUTHORIZED USE

Unless otherwise specified in this data sheet, this product is a standard commercial product and is not intended for use in applications that require extraordinary levels of quality and reliability. This product may not be used in the following applications, unless specifically approved in writing by a Fairchild officer: (1) automotive or other transportation, (2) military/aerospace, (3) any safety critical application – including life critical medical equipment – where the failure of the Fairchild product reasonably would be expected to result in personal injury, death or property damage. Customer's use of this product is subject to agreement of this Authorized Use policy. In the event of an unauthorized use of Fairchild's product, Fairchild accepts no liability in the event of product failure. In other respects, this product shall be subject to Fairchild's Worldwide Terms and Conditions of Sale, unless a separate agreement has been signed by both Parties.

ANTI-COUNTERFEITING POLICY

Fairchild Semiconductor Corporation's Anti-Counterfeiting Policy. Fairchild's Anti-Counterfeiting Policy is also stated on our external website, www.fairchildsemi.com, under Terms of Use

Counterfeiting of semiconductor parts is a growing problem in the industry. All manufacturers of semiconductor products are experiencing counterfeiting of their parts. Customers who inadvertently purchase counterfeit parts experience many problems such as loss of brand reputation, substandard performance, failed applications, and increased cost of production and manufacturing delays. Fairchild is taking strong measures to protect ourselves and our customers from the proliferation of counterfeit parts. Fairchild strongly encourages customers to purchase Fairchild parts either directly from Fairchild or from Authorized Fairchild Distributors who are listed by country on our web page cited above. Products customers buy either from Fairchild directly or from Authorized Fairchild Distributors are genuine parts, have full traceability, meet Fairchild's quality standards for handling and storage and provide access to Fairchild's full range of up-to-date technical and product information. Fairchild and our Authorized Distributors will stand behind all warranties and will appropriately address any warranty issues that may arise. Fairchild will not provide any warranty coverage or other assistance for parts bought from Unauthorized Sources. Fairchild is committed to combat this global problem and encourage our customers to do their part in stopping this practice by buying direct or from authorized distributors.

PRODUCT STATUS DEFINITIONS

Definition of Terms

Datasheet Identification	Product Status	Definition
Advance Information	Formative / In Design	Datasheet contains the design specifications for product development. Specifications may change in any manner without notice.
Preliminary	First Production	Datasheet contains preliminary data; supplementary data will be published at a later date. Fairchild Semiconductor reserves the right to make changes at any time without notice to improve design.
No Identification Needed	Full Production	Datasheet contains final specifications. Fairchild Semiconductor reserves the right to make changes at any time without notice to improve the design.
Obsolete	Not In Production	Datasheet contains specifications on a product that is discontinued by Fairchild Semiconductor. The datasheet is for reference information only.

Mouser Electronics

Authorized Distributor

Click to View Pricing, Inventory, Delivery & Lifecycle Information:

[Fairchild Semiconductor:](#)

[FPF1203LUCX](#)