



Is Now Part of



ON Semiconductor®

To learn more about ON Semiconductor, please visit our website at
www.onsemi.com

ON Semiconductor and the ON Semiconductor logo are trademarks of Semiconductor Components Industries, LLC dba ON Semiconductor or its subsidiaries in the United States and/or other countries. ON Semiconductor owns the rights to a number of patents, trademarks, copyrights, trade secrets, and other intellectual property. A listing of ON Semiconductor's product/patent coverage may be accessed at www.onsemi.com/site/pdf/Patent-Marking.pdf. ON Semiconductor reserves the right to make changes without further notice to any products herein. ON Semiconductor makes no warranty, representation or guarantee regarding the suitability of its products for any particular purpose, nor does ON Semiconductor assume any liability arising out of the application or use of any product or circuit, and specifically disclaims any and all liability, including without limitation special, consequential or incidental damages. Buyer is responsible for its products and applications using ON Semiconductor products, including compliance with all laws, regulations and safety requirements or standards, regardless of any support or applications information provided by ON Semiconductor. "Typical" parameters which may be provided in ON Semiconductor data sheets and/or specifications can and do vary in different applications and actual performance may vary over time. All operating parameters, including "Typicals" must be validated for each customer application by customer's technical experts. ON Semiconductor does not convey any license under its patent rights nor the rights of others. ON Semiconductor products are not designed, intended, or authorized for use as a critical component in life support systems or any FDA Class 3 medical devices or medical devices with a same or similar classification in a foreign jurisdiction or any devices intended for implantation in the human body. Should Buyer purchase or use ON Semiconductor products for any such unintended or unauthorized application, Buyer shall indemnify and hold ON Semiconductor and its officers, employees, subsidiaries, affiliates, and distributors harmless against all claims, costs, damages, and expenses, and reasonable attorney fees arising out of, directly or indirectly, any claim of personal injury or death associated with such unintended or unauthorized use, even if such claim alleges that ON Semiconductor was negligent regarding the design or manufacture of the part. ON Semiconductor is an Equal Opportunity/Affirmative Action Employer. This literature is subject to all applicable copyright laws and is not for resale in any manner.



FPF1320 / FPF1321 IntelliMAX™ Dual-Input Single-Output Advanced Power Switch with True Reverse-Current Blocking

Features

- DISO Load Switches
- Input Supply Operating Range: 1.5 V ~ 5.5 V
- R_{ON} 50 mΩ at V_{IN}=3.3 V Per Channel (Typical)
- True Reverse-Current Blocking (TRCB)
- Fixed Slew Rate Controlled 130 μs for < 1 μF C_{OUT}
- I_{SW}: 1.5 A Per Channel (Maximum)
- Quick Discharge Feature on FPF1321
- Logic CMOS IO Meets JESD76 Standard for GPIO Interface and Related Power Supply Requirements
- ESD Protected:
 - Human Body Model: >6 kV
 - Charged Device Model: >1.5 kV
 - IEC 61000-4-2 Air Discharge: >15 kV
 - IEC 61000-4-2 Contact Discharge: >8 kV

Applications

- Smart phones / Tablet PCs
- Portable Devices
- Near Field Communication (NFC) Capable SIM Card Power Supply

Description

The FPF1320/21 is a Dual-Input Single-Output (DISO) load switch consisting of two sets of slew-rate controlled, low on-resistance, P-channel MOSFET switches and integrated analog features. The slew-rate-controlled turn-on characteristic prevents inrush current and the resulting excessive voltage droop on the power rails. The input voltage range operates from 1.5 V to 5.5 V to align with the requirements of low-voltage portable device power rails. FPF1320/21 performs seamless power-source transitions between two input power rails using the SEL pin with advanced break-before-make operation.

FPF1320/21 has a TRCB function to block unwanted reverse current from output to input during ON/OFF states. The switch is controlled by logic inputs of the SEL and EN pins, which are capable of interfacing directly with low-voltage control signals (GPIO).

FPF1321 has 65 Ω on-chip load resistor for output quick discharge when EN is LOW.

FPF1320/21 is available in 1.0 mm x 1.5 mm WLCSP, 6-bump, with 0.5 mm pitch. FPF1321B is available in 1.0 mm x 1.5 mm WLCSP, 6-bump, 0.5 mm pitch with backside laminate.

Ordering Information

| Part Number | Top Mark | Channel | Switch Per Channel (Typ.) at 3.3 V _{IN} | Reverse Current Blocking | Output Discharge | Rise Time (t _R) | Package |
|-------------|----------|---------|--|--------------------------|------------------|-----------------------------|---|
| FPF1320UCX | QS | DISO | 50 mΩ | Yes | NA | 130 μs | 1.0 mm X 1.5 mm Wafer-Level Chip-Scale Package (WLCSP) 6-Bumps, 0.5 mm Pitch |
| FPF1321UCX | QT | DISO | 50 mΩ | Yes | 65 Ω | 130 μs | |
| FPF1321BUCX | QT | DISO | 50 mΩ | Yes | 65 Ω | 130 μs | 1.0 mm X 1.5 mm Wafer-Level Chip-Scale Package (WLCSP) 6-Bumps, 0.5 mm Pitch with Backside Laminate |

Application Diagram

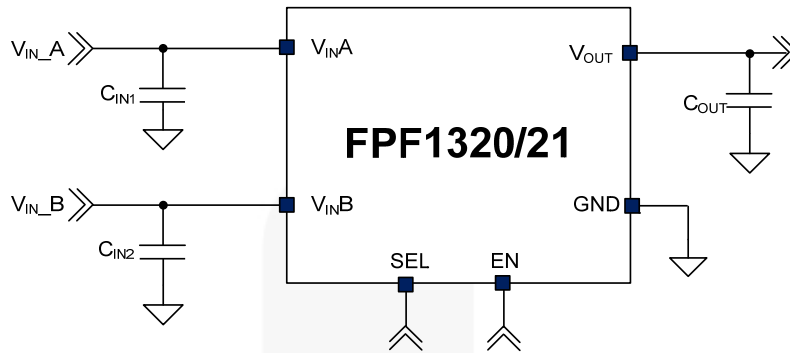

Figure 1. Typical Application

Block Diagram

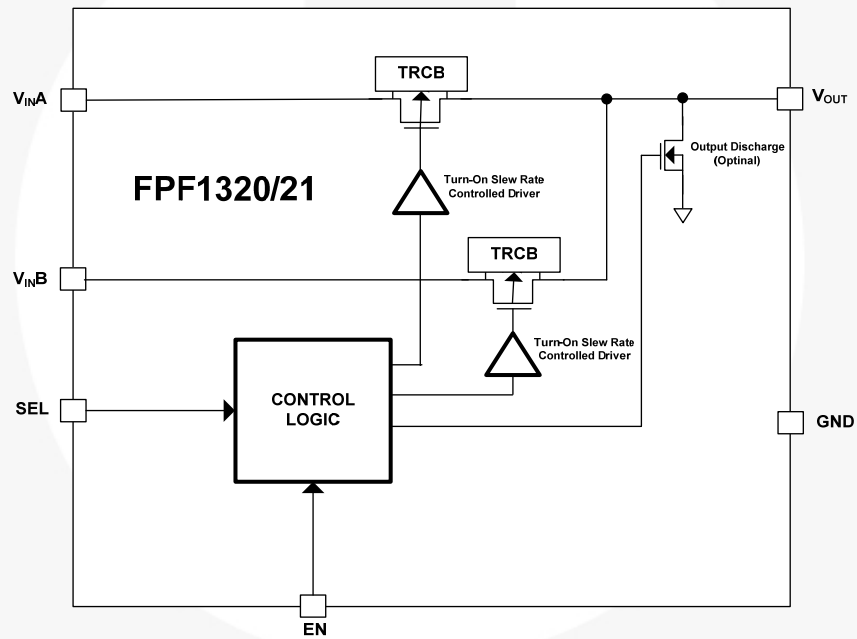

Figure 2. Functional Block Diagram (Output Discharge Path for FPF1321 Only)

Pin Configuration

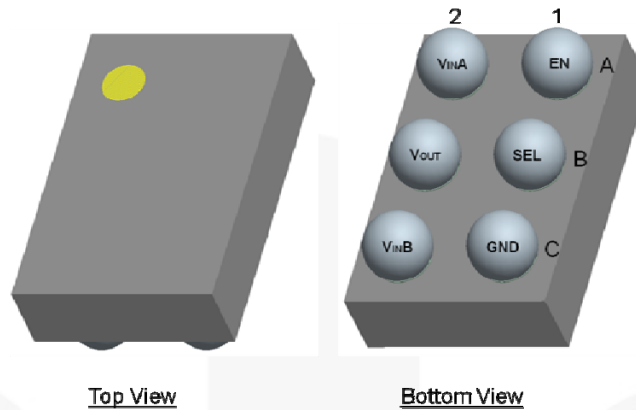

Figure 3. Pin Configuration in Package View with Pin 1 Indicator

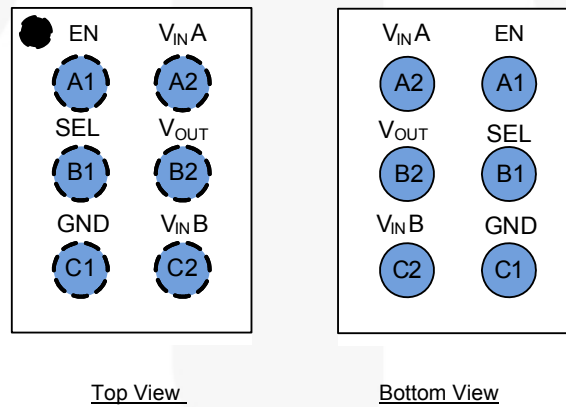

Figure 4. Pin Assignments

Pin Description

| Pin # | Name | Description |
|-------|-------------------|--|
| A1 | EN | Enable input. Active HIGH. There is an internal pull-down resistor at the EN pin. |
| B1 | SEL | Input power selection inputs. See Table 1. There are internal pull-down resistors at the SEL pins. |
| A2 | V _{IN A} | Supply Input. Input to the power switch A. |
| B2 | V _{OUT} | Switch output |
| C1 | GND | Ground |
| C2 | V _{IN B} | Supply Input. Input to power switch B. |

Table 1. Truth Table

| SEL | EN | Switch A | Switch B | V _{OUT} | Status |
|------|------|----------|----------|---|----------------------------|
| LOW | HIGH | ON | OFF | V _{IN A} | V _{IN A} Selected |
| HIGH | HIGH | OFF | ON | V _{IN B} | V _{IN B} Selected |
| X | LOW | OFF | OFF | Floating for FPF1320 GND for FPF1321 | Both Switches are OFF |

Absolute Maximum Ratings

Stresses exceeding the Absolute Maximum Ratings may damage the device. The device may not function or be operable above the recommended operating conditions and stressing the parts to these levels is not recommended. In addition, extended exposure to stresses above the recommended operating conditions may affect device reliability. The absolute maximum ratings are stress ratings only.

| Symbol | Parameters | Min. | Max. | Unit |
|---------------|---|---|--------------------|--------------------|
| V_{IN} | V_{INA} , V_{INB} , V_{SEL} , V_{EN} , V_{OUT} to GND | -0.3 | 6 | V |
| I_{SW} | Maximum Continuous Switch Current per Channel | | 1.5 | A |
| P_D | Total Power Dissipation at $T_A=25^\circ\text{C}$ | | 1.2 | W |
| T_{STG} | Operating and Storage Junction Temperature | -65 | 150 | $^\circ\text{C}$ |
| Θ_{JA} | Thermal Resistance, Junction-to-Ambient (1 in. ² Pad of 2-oz. Copper) | | 85 ⁽¹⁾ | $^\circ\text{C/W}$ |
| | | | 110 ⁽²⁾ | |
| ESD | Electrostatic Discharge Capability | Human Body Model, JESD22-A114 | 6.0 | kV |
| | | Charged Device Model, JESD22-C101 | 1.5 | |
| | | Air Discharge (V_{INA} , V_{INB} to GND), IEC61000-4-2 System Level | 15.0 | |
| | | Contact Discharge (V_{INA} , V_{INB} to GND), IEC61000-4-2 System Level | 8.0 | |

Notes:

1. Measured using 2S2P JEDEC std. PCB.
2. Measured using 2S2P JEDEC PCB cold-plate method.

Recommended Operating Conditions

The Recommended Operating Conditions table defines the conditions for actual device operation. Recommended operating conditions are specified to ensure optimal performance to the datasheet specifications. Fairchild does not recommend exceeding them or designing to Absolute Maximum Ratings.

| Symbol | Parameters | Min. | Max. | Unit |
|----------|--|------|------|------------------|
| V_{IN} | Input Voltage on V_{INA} , V_{INB} | 1.5 | 5.5 | V |
| T_A | Ambient Operating Temperature | -40 | 85 | $^\circ\text{C}$ |

Electrical Characteristics

$V_{IN A}=V_{IN B}=1.5$ to 5.5 V, $T_A=-40$ to 85°C unless otherwise noted. Typical values are at $V_{IN A}=V_{IN B}=3.3$ V and $T_A=25^\circ\text{C}$.

| Symbol | Parameters | Condition | Min. | Typ. | Max. | Unit |
|--------------------------------------|---|---|------|------|------|---------------|
| Basic Operation | | | | | | |
| $V_{IN A}, V_{IN B}$ | Input Voltage | | 1.5 | | 5.5 | V |
| I_{SD} | Shutdown Current | SEL=HIGH or LOW, EN=GND, $V_{OUT}=GND$, $V_{IN A}=V_{IN B}=5.5$ V | | | 5 | μA |
| I_Q | Quiescent Current | $I_{OUT}=0\text{mA}$, SEL=HIGH or LOW, EN=HIGH, $V_{IN A}=V_{IN B}=5.5$ V | | 12 | 22 | μA |
| R_{ON} | On-Resistance | $V_{IN A}=V_{IN B}=5.5$ V, $I_{OUT}=200$ mA, $T_A=25^\circ\text{C}$ | | 42 | 60 | m Ω |
| | | $V_{IN A}=V_{IN B}=3.3$ V, $I_{OUT}=200$ mA, $T_A=25^\circ\text{C}$ | | 50 | | |
| | | $V_{IN A}=V_{IN B}=1.8$ V, $I_{OUT}=200$ mA, $T_A=25^\circ\text{C}$ to 85°C | | 80 | | |
| | | $V_{IN A}=V_{IN B}=1.5$ V, $I_{OUT}=200$ mA, $T_A=25^\circ\text{C}$ | | | 170 | |
| V_{IH} | SEL, EN Input Logic High Voltage | $V_{IN A}, V_{IN B}=1.5$ V – 5.5 V | 1.15 | | | V |
| V_{IL} | SEL, EN Input Logic Low Voltage | $V_{IN A}, V_{IN B}=1.8$ V – 5.5 V | | | 0.65 | V |
| | SEL, EN Input Logic Low Voltage | $V_{IN A}, V_{IN B}=1.5$ V – 1.8 V | | | 0.60 | |
| V_{DROOP_OUT} | Output Voltage Droop while Channel Switching from Higher Input Voltage Lower Input Voltage ⁽³⁾ | $V_{IN A}=3.3$ V, $V_{IN B}=5$ V, Switching from $V_{IN A} \rightarrow V_{IN B}$, $R_L=150$ Ω , $C_{OUT}=1$ μF | | | 100 | mV |
| I_{SEL}/I_{EN} | Input Leakage at SEL and EN Pin | | | | 1.2 | μA |
| R_{SEL_PD}/R_{EN_PD} | Pull-Down Resistance at SEL or EN Pin | | | 7 | | M Ω |
| R_{PD} | Output Pull-Down Resistance | SEL=HIGH or LOW, EN=GND, $I_{FORCE}=20$ mA, $T_A=25^\circ\text{C}$, FPF1321 | | 65 | | Ω |
| True Reverse Current Blocking | | | | | | |
| V_{T_RCB} | RCB Protection Trip Point | $V_{OUT} - V_{IN A}$ or $V_{IN B}$ | | 45 | | mV |
| V_{R_RCB} | RCB Protection Release Trip Point | $V_{IN A}$ or $V_{IN B} - V_{OUT}$ | | 25 | | mV |
| I_{RCB} | $V_{IN A}$ or $V_{IN B}$ Current During RCB | $V_{OUT}=5.5$ V, $V_{IN A}$ or $V_{IN B}$ =Short to GND | | 9 | 15 | μA |
| t_{RCB_ON} | RCB Response Time when Device is ON ⁽³⁾ | $V_{IN A}$ or $V_{IN B}=5$ V, $V_{OUT}V_{IN A,B}=100$ mV | | 5 | | μs |

Continued on the following page...

Electrical Characteristics (Continued)

 $V_{IN A}=V_{IN B}=1.5$ to 5.5 V, $T_A=-40$ to 85°C unless otherwise noted. Typical values are at $V_{IN A}=V_{IN B}=3.3$ V and $T_A=25^\circ\text{C}$.

| Symbol | Parameters | Condition | Min. | Typ. | Max. | Unit |
|--------------------------------|--|--|------|------|------|---------------|
| Dynamic Characteristics | | | | | | |
| t_{DON} | Turn-On Delay ⁽⁴⁾ | $V_{IN A}$ or $V_{IN B}=3.3$ V, $R_L=150$ Ω , $C_L=1$ μF , $T_A=25^\circ\text{C}$, SEL: HIGH, EN: LOW \rightarrow HIGH | | 120 | | μs |
| t_R | V_{OUT} Rise Time ⁽⁴⁾ | | | 130 | | μs |
| t_{ON} | Turn-On Time ⁽⁶⁾ | | | 250 | | μs |
| t_{DOFF} | Turn-Off Delay ⁽⁴⁾ | $V_{IN A}$ or $V_{IN B}=3.3$ V, $R_L=150$ Ω , $C_L=1$ μF , $T_A=25^\circ\text{C}$, SEL: HIGH, EN: HIGH \rightarrow LOW | | 15 | | μs |
| t_F | V_{OUT} Fall Time ⁽⁴⁾ | | | 320 | | μs |
| t_{OFF} | Turn-Off Time ⁽⁷⁾ | | | 335 | | μs |
| t_{DOFF} | Turn-Off Delay ^(4,5) | $V_{IN A}$ or $V_{IN B}=3.3$ V, $R_L=150$ Ω , $C_L=1$ μF , $T_A=25^\circ\text{C}$, SEL: HIGH, EN: HIGH \rightarrow LOW, Output Discharge Mode, FPF1321 | | 6 | | μs |
| t_F | V_{OUT} Fall Time ^(4,5) | | | 110 | | μs |
| t_{OFF} | Turn-Off Time ^(5,7) | | | 116 | | μs |
| t_{TRANR} | Transition Time LOW \rightarrow HIGH ⁽⁴⁾ | $V_{IN A}=3.3$ V, $V_{IN B}=5$ V, Switching from $V_{IN A} \rightarrow V_{IN B}$, SEL: LOW \rightarrow HIGH, EN: HIGH, $R_L=150$ Ω , $C_L=1$ μF , $T_A=25^\circ\text{C}$ | | 3 | | μs |
| t_{SLH} | Switch-Over Rising Delay ⁽⁴⁾ | | | 1 | | μs |
| t_{TRANF} | Transition Time HIGH \rightarrow LOW ⁽⁴⁾ | $V_{IN A}=3.3$ V, $V_{IN B}=5$ V, Switching from $V_{IN B} \rightarrow V_{IN A}$, SEL: HIGH \rightarrow LOW, EN: HIGH, $R_L=150$ Ω , $C_L=1$ μF , $T_A=25^\circ\text{C}$ | | 45 | | μs |
| t_{SHL} | Switch-Over Falling Delay ⁽⁴⁾ | | | 5 | | μs |

Notes:

- This parameter is guaranteed by design and characterization; not production tested.
- $t_{DON}/t_{DOFF}/t_R/t_F/t_{TRANR}/t_{TRANF}/t_{SLH}/t_{SHL}$ are defined in Figure 5.
- FPF1321 output discharge is enabled during off.
- $t_{ON}=t_R + t_{DON}$.
- $t_{OFF}=t_F + t_{DOFF}$.

Timing Diagram

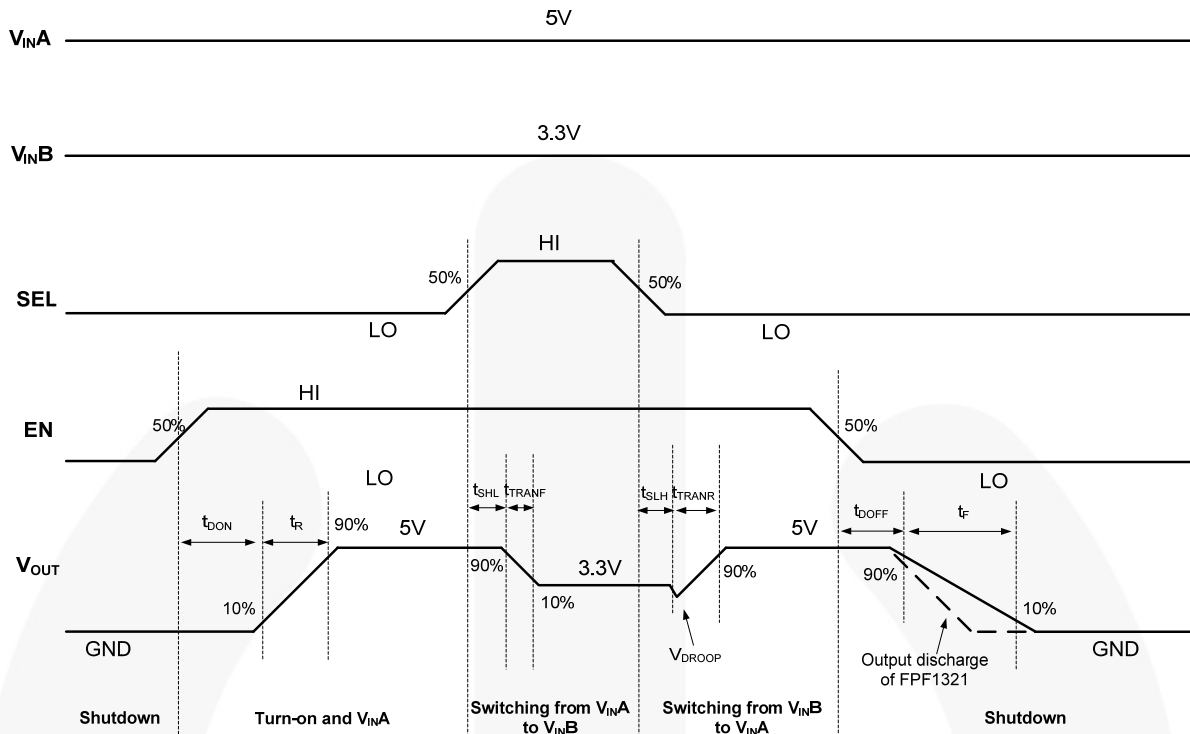

Figure 5. Dynamic Behavior Timing Diagram

Typical Characteristics

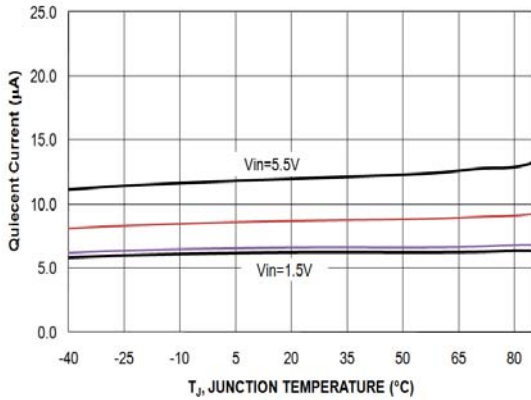

Figure 6. Supply Current vs. Temperature

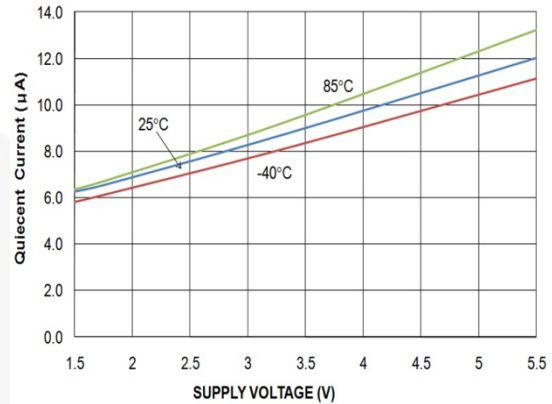

Figure 7. Supply Current vs. Supply Voltage

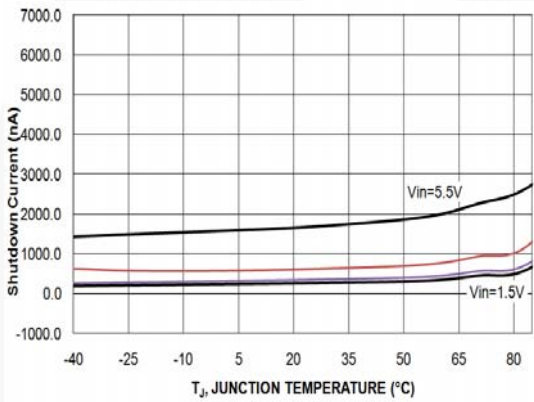

Figure 8. Shutdown Current vs. Temperature

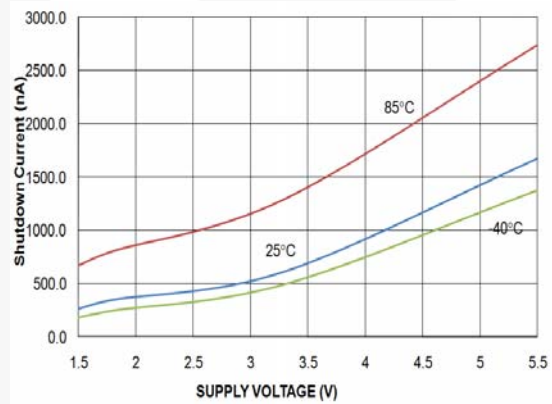

Figure 9. Shutdown Current vs. Supply Voltage

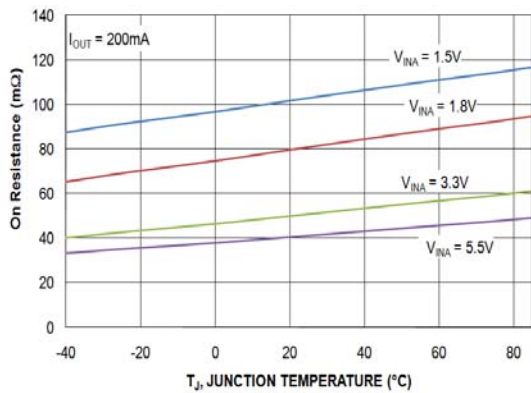

Figure 10. R_{ON} vs. Temperature

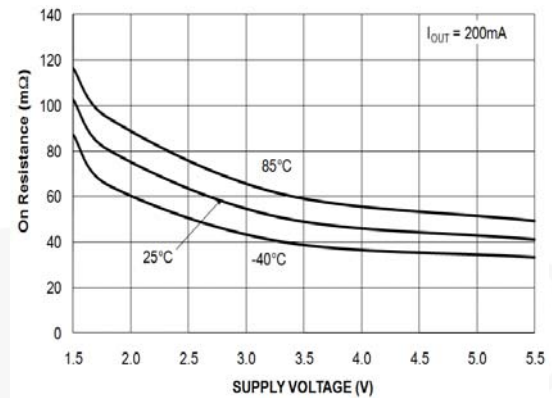

Figure 11. R_{ON} vs. Supply Voltage

Continued on the following page...

Typical Characteristics

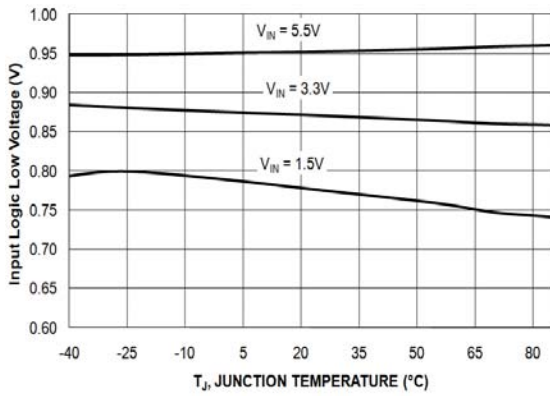

Figure 12. V_{IL} vs. Temperature

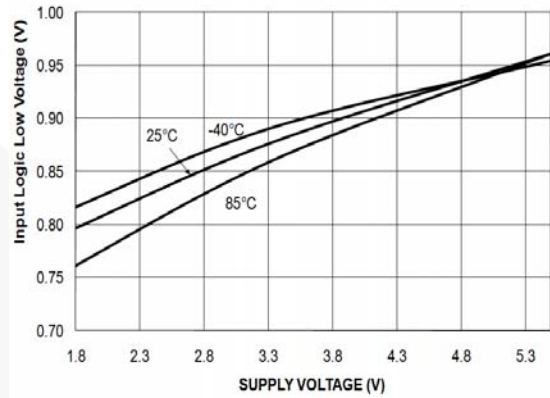

Figure 13. V_{IL} vs. Supply Voltage

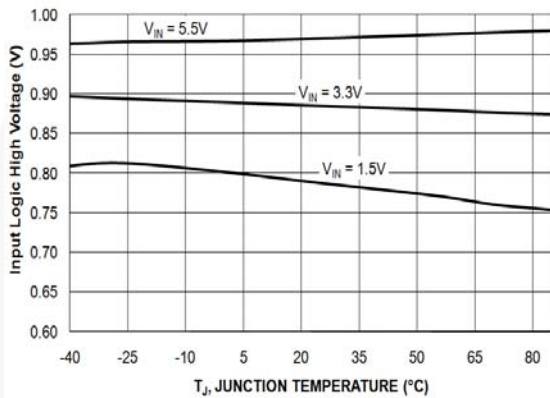

Figure 14. V_{IH} vs. Temperature

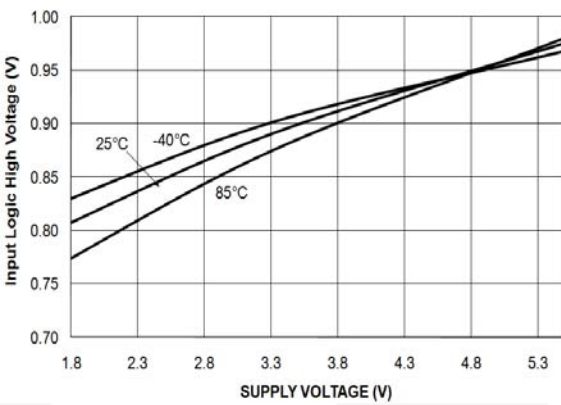

Figure 15. V_{IH} vs. Supply Voltage

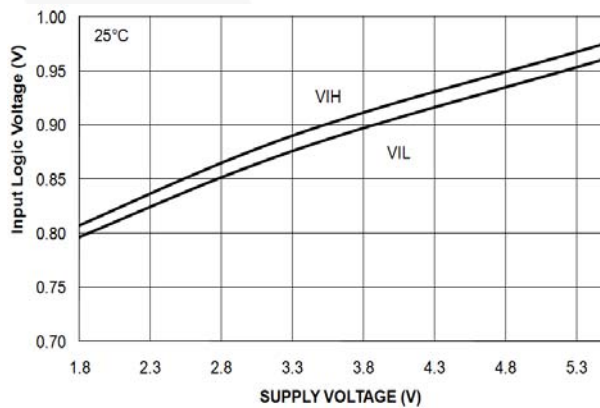

Figure 16. V_{IH} / V_{IL} vs. Supply Voltage

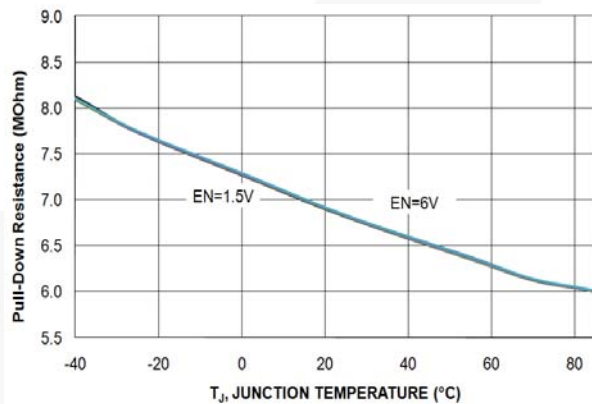

Figure 17. R_{SEL_PD} and R_{EN_PD} vs. Temperature

Continued on the following page...

Typical Characteristics

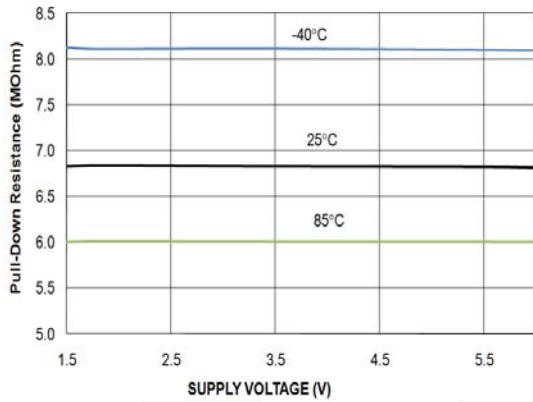

Figure 18. R_{SEL_PD} and R_{EN_PD} vs. Supply Voltage

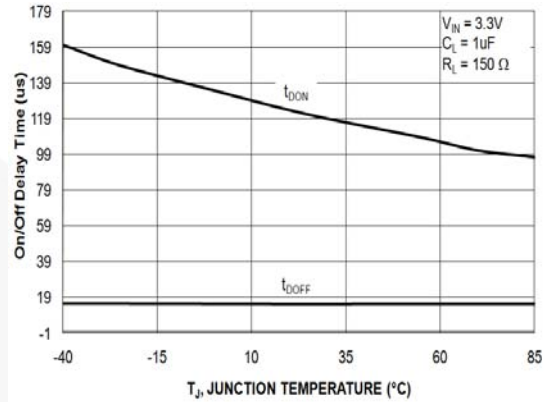

Figure 19. t_{DON} and t_{DOFF} vs. Temperature

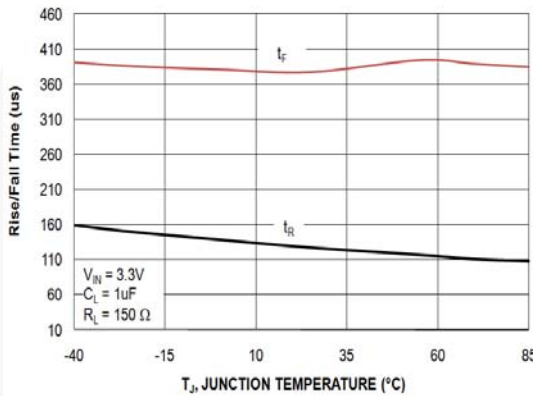

Figure 20. t_R and t_F with FPF1320 vs. Temperature

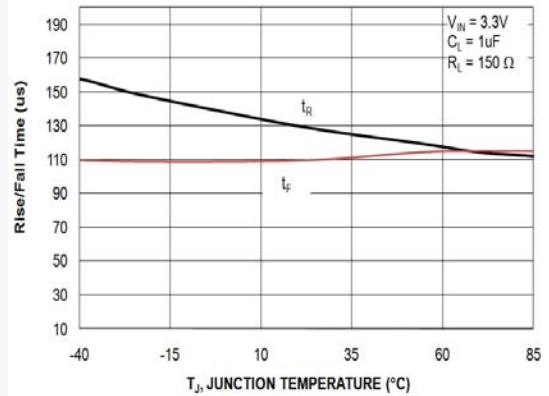

Figure 21. t_R and t_F with FPF1321 vs. Temperature

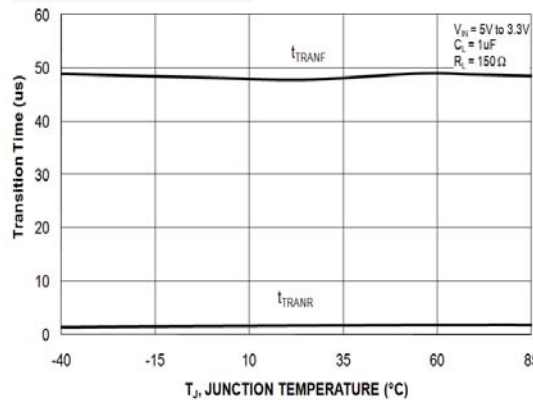

Figure 22. Transition Time vs. Temperature

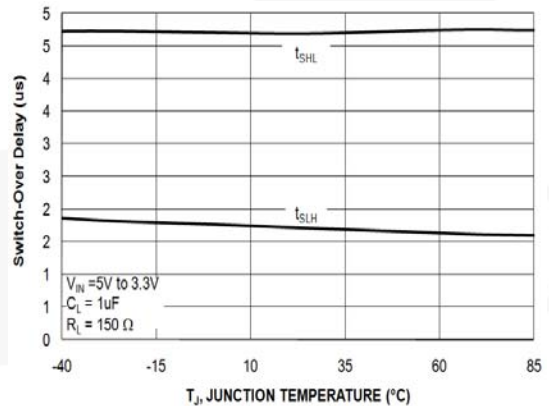

Figure 23. Switch Over Time vs. Temperature

Continued on the following page...

Typical Characteristics

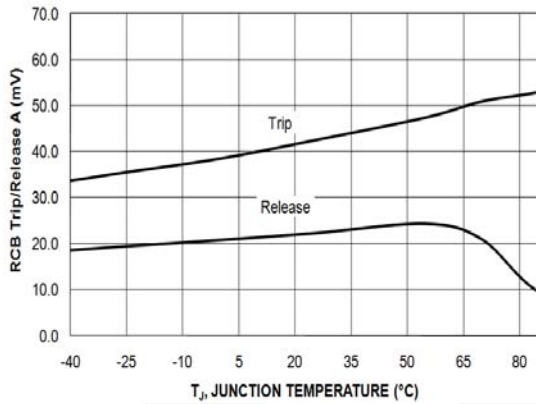

Figure 24. TRCB Trip and Release vs. Temperature

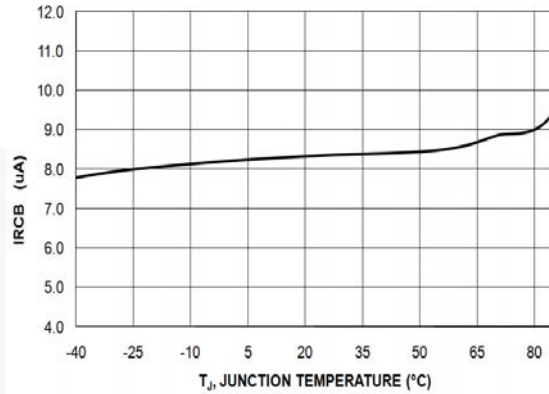

Figure 25. I_{RCB} vs. Temperature

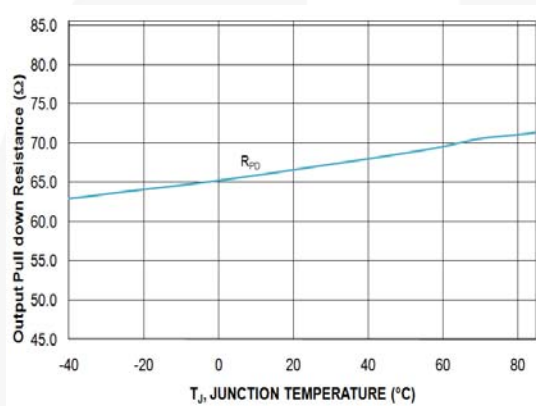

Figure 26. R_{PD} with FPF1321 vs. Temperature

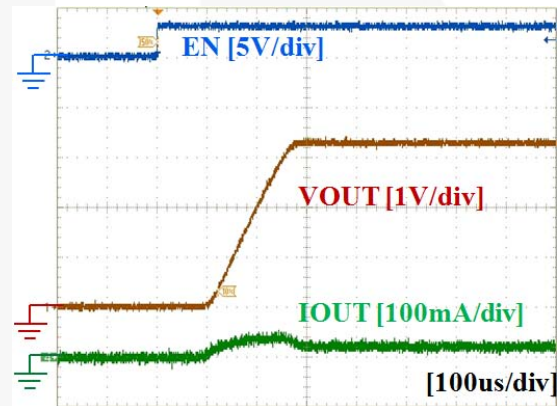

Figure 27. Turn-On Response
($V_{IN A}=3.3\text{ V}$, $C_{IN}=1\text{ }\mu\text{F}$, $C_{OUT}=1\text{ }\mu\text{F}$, $R_L=150\text{ }\Omega$,
 $SEL=LOW$)

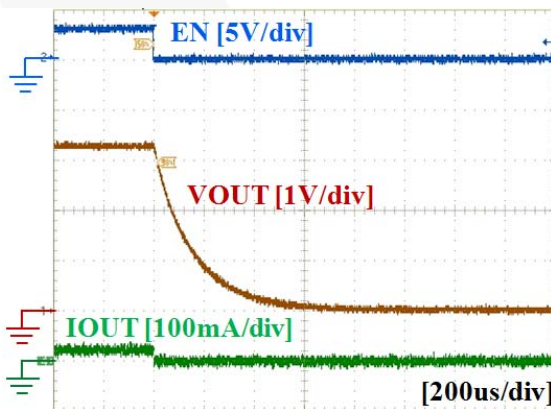

Figure 28. Turn-Off Response with FPF1320
($V_{IN A}=3.3\text{ V}$, $C_{IN}=1\text{ }\mu\text{F}$, $C_{OUT}=1\text{ }\mu\text{F}$, $R_L=150\text{ }\Omega$,
 $SEL=LOW$)

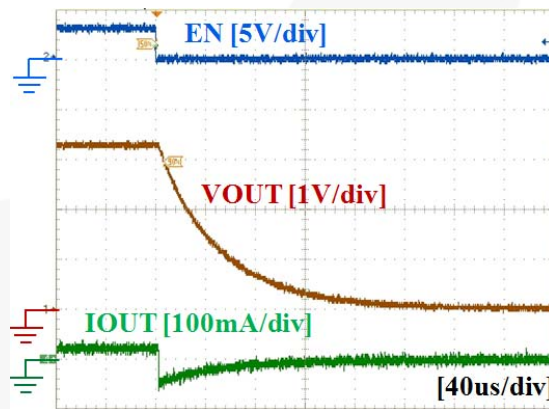

Figure 29. Turn-Off Response with FPF1321
($V_{IN A}=3.3\text{ V}$, $C_{IN}=1\text{ }\mu\text{F}$, $C_{OUT}=1\text{ }\mu\text{F}$, $R_L=150\text{ }\Omega$,
 $SEL=LOW$)

Continued on the following page...

Typical Characteristics

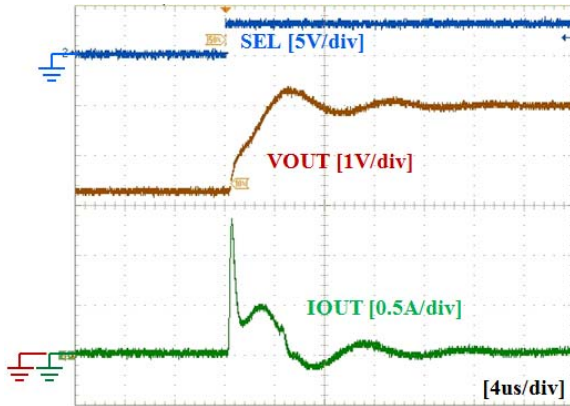

Figure 30. Power Source Transition from 3.3 V to 5 V ($V_{IN A}=3.3$ V, $V_{IN B}=5$ V, $C_{IN}=1$ μ F, $C_{OUT}=1$ μ F, $R_L=150$ Ω)

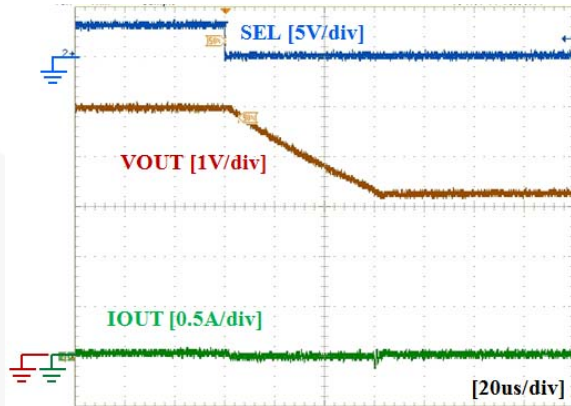

Figure 31. Power Source Transition from 5 V to 3.3 V ($V_{IN A}=3.3$ V, $V_{IN B}=5$ V, $C_{IN}=1$ μ F, $C_{OUT}=1$ μ F, $R_L=150$ Ω)

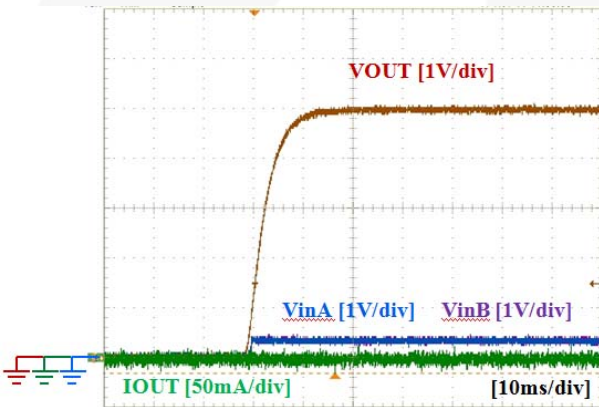

Figure 32. TRCB During Off ($V_{IN A}=V_{IN B}$ =Floating, $V_{OUT}=5$ V, $C_{IN}=1$ μ F, $C_{OUT}=1$ μ F, $EN=LOW$, No R_L)

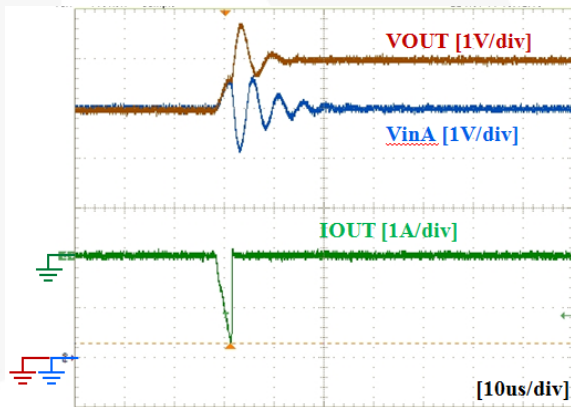

Figure 33. TRCB During On ($V_{IN A}=5$ V, $V_{OUT}=6$ V, $C_{IN}=1$ μ F, $C_{OUT}=1$ μ F, $EN=HIGH$, No R_L)

Operation and Application Description

The FPF1320 and FPF1321 are dual-input single-output power multiplexer switches with controlled turn-on and seamless power source transition. The core is a 50 mΩ P-channel MOSFET and controller capable of functioning over a wide input operating range of 1.5 V to 5.5 V per channel. The EN and SEL pins are active-HIGH, GPIO/CMOS-compatible input. They control the state of the switch and input power source selection, respectively. TRCB functionality blocks unwanted reverse current during both ON and OFF states when higher V_{OUT} than $V_{IN A}$ or $V_{IN B}$ is applied. FPF1321 has a 65 Ω output discharge path during off.

Input Capacitor

To limit the voltage drop on the input supply caused by transient inrush current when the switch turns on into a discharged load capacitor; a capacitor must be placed between the $V_{IN A}$ or $V_{IN B}$ pins to the GND pin. At least 1 μF ceramic capacitor, C_{IN} , placed close to the pins, is usually sufficient. Higher-value C_{IN} can be used to reduce more the voltage drop.

Inrush Current

Inrush current occurs when the device is turned on. Inrush current is dependent on output capacitance and slew rate control capability, as expressed by:

$$I_{INRUSH} = C_{OUT} \times \frac{V_{IN} - V_{INITIAL}}{t_R} + I_{LOAD} \quad (1)$$

where:

C_{OUT} : Output capacitance;

t_R : Slew rate or rise time at V_{OUT} ;

V_{IN} : Input voltage, $V_{IN A}$ or $V_{IN B}$;

$V_{INITIAL}$: Initial voltage at C_{OUT} , usually GND; and

I_{LOAD} : Load current.

Higher inrush current causes higher input voltage drop, depending on the distributed input resistance and input capacitance. High inrush current can cause problems.

FPF1320/1 has a 130 μs of slew rate capability under 3.3 V_{IN} at 1 μF of C_{OUT} and 150 Ω of R_L so inrush current and input voltage drop can be minimized.

Power Source Selection

Input power source selection can be controlled by the SEL pin. When SEL is LOW, output is powered from $V_{IN A}$ while SEL is HIGH, $V_{IN B}$ is powering output. The SEL signal is ignored during device OFF.

Output Voltage Drop during Transition

Output voltage drop usually occurs during input power source transition period from low voltage to high voltage. The drop is highly dependent on output capacitance and load current.

FPF1320/1 adopts an advanced break-before-make control, which can result in minimized output voltage drop during the transition time.

Output Capacitor

Capacitor C_{OUT} of at least 1 μF is highly recommended between the V_{OUT} and GND pins to achieve minimized output voltage drop during input power source transition. This capacitor also prevents parasitic board inductance.

True Reverse-Current Blocking

The true reverse-current blocking feature protects the input source against current flow from output to input regardless of whether the load switch is on or off.

Board Layout

For best performance, all traces should be as short as possible. To be most effective, the input and output capacitors should be placed close to the device to minimize the effect that parasitic trace inductance on normal and short-circuit operation. Wide traces or large copper planes for power pins ($V_{IN A}$, $V_{IN B}$, V_{OUT} and GND) minimize the parasitic electrical effects and the thermal impedance.

Physical Dimensions

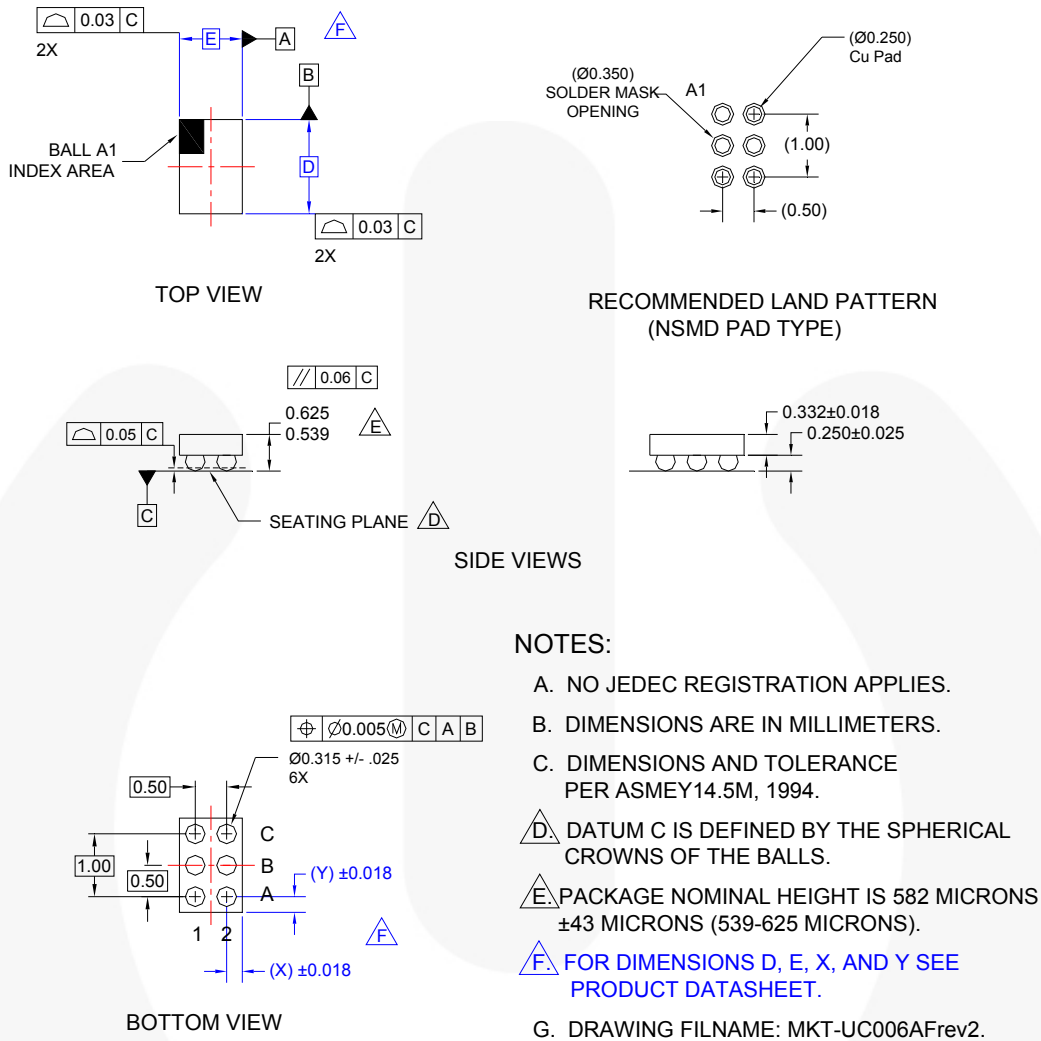

Figure 34. 6-Ball, 1.0 x 1.5 mm, Wafer-Level Chip-Scale Package (WLCSP)

Product-Specific Dimensions

| Product | D | E | X | Y |
|-------------|----------------|---------------|--------|--------|
| FPF1320UCX | 1460 µm ±30 µm | 960 µm ±30 µm | 230 µm | 230 µm |
| FPF1321UCX | 1460 µm ±30 µm | 960 µm ±30 µm | 230 µm | 230 µm |
| FPF1321BUCX | 1460 µm ±30 µm | 960 µm ±30 µm | 230 µm | 230 µm |

Package drawings are provided as a service to customers considering Fairchild components. Drawings may change in any manner without notice. Please note the revision and/or date on the drawing and contact a Fairchild Semiconductor representative to verify or obtain the most recent revision. Package specifications do not expand the terms of Fairchild's worldwide terms and conditions, specifically the warranty therein, which covers Fairchild products.

Always visit Fairchild Semiconductor's online packaging area for the most recent package drawings:

<http://www.fairchildsemi.com/packaging/>

<http://www.fairchildsemi.com/dwg/UC/UC006AF.pdf>



TRADEMARKS

The following includes registered and unregistered trademarks and service marks, owned by Fairchild Semiconductor and/or its global subsidiaries, and is not intended to be an exhaustive list of all such trademarks:

- | | | | |
|---|--|--|---|
| AccuPower™ | F-PFST™ |  | Sync-Lock™ |
| AX-CAP [®] | FRFET [®] | PowerTrench [®] |  |
| BitSiC™ | Global Power Resource SM | PowerXS™ | TinyBoost [®] |
| Build it Now™ | GreenBridge™ | Programmable Active Droop™ | TinyBuck [®] |
| CorePLUS™ | Green FPS™ | QFET [®] | TinyCalc™ |
| CorePOWER™ | Green FPS™ e-Series™ | QST™ | TinyLogic [®] |
| CROSSVOLT™ | Gmax™ | Quiet Series™ | TINYOPTO™ |
| CTL™ | GTO™ | RapidConfigure™ | TinyPower™ |
| Current Transfer Logic™ | IntelliMAX™ |  Saving our world, 1mW/WkW at a time™ | TinyPWM™ |
| DEUXPEED [®] | ISOPLANAR™ | SignalWise™ | TinyWire™ |
| Dual Cool™ | Making Small Speakers Sound Louder and Better™ | SmartMax™ | TranSiC™ |
| EcoSPARK [®] | MegaBuck™ | SMART START™ | TriFault Detect™ |
| EfficientMax™ | MICROCOUPLER™ | Solutions for Your Success™ | TRUECURRENT [®] |
| ESBC™ | MicroFET™ | SPM [®] | μSerDes™ |
|  | MicroPak™ | STEALTH™ |  |
| Fairchild [®] | MicroPak2™ | SuperFET [®] | UHC [®] |
| Fairchild Semiconductor [®] | MillerDrive™ | SuperSOT™-3 | Ultra FRFET™ |
| FACT Quiet Series™ | MotionMax™ | SuperSOT™-8 | UniFET™ |
| FACT [®] | mWSaver [®] | SuperSOT™-8 | VCX™ |
| FAST [®] | OptoHiT™ | SupreMOS [®] | VisualMax™ |
| FastvCore™ | OPTOLOGIC [®] | SyncFET™ | VoltagePlus™ |
| FETBench™ | OPTOPLANAR [®] | | XS™ |
| FPS™ | | | |

* Trademarks of System General Corporation, used under license by Fairchild Semiconductor.

DISCLAIMER

FAIRCHILD SEMICONDUCTOR RESERVES THE RIGHT TO MAKE CHANGES WITHOUT FURTHER NOTICE TO ANY PRODUCTS HEREIN TO IMPROVE RELIABILITY, FUNCTION, OR DESIGN. FAIRCHILD DOES NOT ASSUME ANY LIABILITY ARISING OUT OF THE APPLICATION OR USE OF ANY PRODUCT OR CIRCUIT DESCRIBED HEREIN; NEITHER DOES IT CONVEY ANY LICENSE UNDER ITS PATENT RIGHTS, NOR THE RIGHTS OF OTHERS. THESE SPECIFICATIONS DO NOT EXPAND THE TERMS OF FAIRCHILD'S WORLDWIDE TERMS AND CONDITIONS, SPECIFICALLY THE WARRANTY THEREIN, WHICH COVERS THESE PRODUCTS.

LIFE SUPPORT POLICY

FAIRCHILD'S PRODUCTS ARE NOT AUTHORIZED FOR USE AS CRITICAL COMPONENTS IN LIFE SUPPORT DEVICES OR SYSTEMS WITHOUT THE EXPRESS WRITTEN APPROVAL OF FAIRCHILD SEMICONDUCTOR CORPORATION.

As used herein:

1. Life support devices or systems are devices or systems which, (a) are intended for surgical implant into the body or (b) support or sustain life, and (c) whose failure to perform when properly used in accordance with instructions for use provided in the labeling, can be reasonably expected to result in a significant injury of the user.
2. A critical component in any component of a life support, device, or system whose failure to perform can be reasonably expected to cause the failure of the life support device or system, or to affect its safety or effectiveness.

ANTI-COUNTERFEITING POLICY

Fairchild Semiconductor Corporation's Anti-Counterfeiting Policy. Fairchild's Anti-Counterfeiting Policy is also stated on our external website, www.fairchildsemi.com, under Sales Support.

Counterfeiting of semiconductor parts is a growing problem in the industry. All manufacturers of semiconductor products are experiencing counterfeiting of their parts. Customers who inadvertently purchase counterfeit parts experience many problems such as loss of brand reputation, substandard performance, failed applications, and increased cost of production and manufacturing delays. Fairchild is taking strong measures to protect ourselves and our customers from the proliferation of counterfeit parts. Fairchild strongly encourages customers to purchase Fairchild parts either directly from Fairchild or from Authorized Fairchild Distributors who are listed by country on our web page cited above. Products customers buy either from Fairchild directly or from Authorized Fairchild Distributors are genuine parts, have full traceability, meet Fairchild's quality standards for handling and storage and provide access to Fairchild's full range of up-to-date technical and product information. Fairchild and our Authorized Distributors will stand behind all warranties and will appropriately address any warranty issues that may arise. Fairchild will not provide any warranty coverage or other assistance for parts bought from Unauthorized Sources. Fairchild is committed to combat this global problem and encourage our customers to do their part in stopping this practice by buying direct or from authorized distributors.

PRODUCT STATUS DEFINITIONS

Definition of Terms

| Datasheet Identification | Product Status | Definition |
|--------------------------|-----------------------|---|
| Advance Information | Formative / In Design | Datasheet contains the design specifications for product development. Specifications may change in any manner without notice. |
| Preliminary | First Production | Datasheet contains preliminary data; supplementary data will be published at a later date. Fairchild Semiconductor reserves the right to make changes at any time without notice to improve design. |
| No Identification Needed | Full Production | Datasheet contains final specifications. Fairchild Semiconductor reserves the right to make changes at any time without notice to improve the design. |
| Obsolete | Not In Production | Datasheet contains specifications on a product that is discontinued by Fairchild Semiconductor. The datasheet is for reference information only. |

Rev. I66

Mouser Electronics

Authorized Distributor

Click to View Pricing, Inventory, Delivery & Lifecycle Information:

[Fairchild Semiconductor:](#)

[FPF1321UCX](#) [FPF1321BUCX](#)