



Is Now Part of



ON Semiconductor®

To learn more about ON Semiconductor, please visit our website at
www.onsemi.com

ON Semiconductor and the ON Semiconductor logo are trademarks of Semiconductor Components Industries, LLC dba ON Semiconductor or its subsidiaries in the United States and/or other countries. ON Semiconductor owns the rights to a number of patents, trademarks, copyrights, trade secrets, and other intellectual property. A listing of ON Semiconductor's product/patent coverage may be accessed at www.onsemi.com/site/pdf/Patent-Marking.pdf. ON Semiconductor reserves the right to make changes without further notice to any products herein. ON Semiconductor makes no warranty, representation or guarantee regarding the suitability of its products for any particular purpose, nor does ON Semiconductor assume any liability arising out of the application or use of any product or circuit, and specifically disclaims any and all liability, including without limitation special, consequential or incidental damages. Buyer is responsible for its products and applications using ON Semiconductor products, including compliance with all laws, regulations and safety requirements or standards, regardless of any support or applications information provided by ON Semiconductor. "Typical" parameters which may be provided in ON Semiconductor data sheets and/or specifications can and do vary in different applications and actual performance may vary over time. All operating parameters, including "Typicals" must be validated for each customer application by customer's technical experts. ON Semiconductor does not convey any license under its patent rights nor the rights of others. ON Semiconductor products are not designed, intended, or authorized for use as a critical component in life support systems or any FDA Class 3 medical devices or medical devices with a same or similar classification in a foreign jurisdiction or any devices intended for implantation in the human body. Should Buyer purchase or use ON Semiconductor products for any such unintended or unauthorized application, Buyer shall indemnify and hold ON Semiconductor and its officers, employees, subsidiaries, affiliates, and distributors harmless against all claims, costs, damages, and expenses, and reasonable attorney fees arising out of, directly or indirectly, any claim of personal injury or death associated with such unintended or unauthorized use, even if such claim alleges that ON Semiconductor was negligent regarding the design or manufacture of the part. ON Semiconductor is an Equal Opportunity/Affirmative Action Employer. This literature is subject to all applicable copyright laws and is not for resale in any manner.



FPF34891 / FPF34892 SIDO Over-Voltage Protection Load Switch

Features

- Single Input Dual Output (SIDO) Switch
 - V_{BUS} to V_{OUT} Path
 - V_{BUS} to BAT Path
- Surge Protection under IEC 61000-4-5
 - V_{BUS} : ± 100 V
- Input Voltage Range
 - V_{BUS} : 2.7 V ~ 13.5 V
- Max. Continuous Current Capability
 - V_{OUT} Path: 3.5 A
 - BAT Path: 6 A
- Ultra Low On-Resistance
 - V_{OUT} Path: Typ. 28 m Ω
 - BAT Path: Typ. 33 m Ω
- Selectable OVLO for V_{OUT} Path
- Programmable OVLO for V_{BAT}
- Over-Voltage Protection (OVP)
 - V_{OUT} Path: 13.9 V \pm 400 mV (FPF34891)
 - V_{OUT} Path: 10.4 V \pm 300 mV (FPF34892)
 - V_{OUT} Path: 5.8 V \pm 200 mV (OVSEL = GND)
 - BAT Path: 5.8 V \pm 200 mV
- Active LOW Control for V_{BUS} to V_{OUT} Path
- Active HIGH Control for V_{BUS} to BAT Path
- CMOS Output PowerGOOD for V_{BUS} to BAT Path
- RCB for V_{BUS} to BAT Path
- Over-Temperature Protection (OTP)

Description

The FPF3489x features a Single Input Dual Output (SIDO) power switch, which offers surge protection and Over-Voltage Protection (OVP), to protect downstream components and enhancing overall system robustness.

Channel one (V_{BUS} to V_{OUT}) is an active-low, 28 V/3.5 A rated, power MOSFET switch with an internal clamp supporting ± 100 V surge protection, fixed OVP at 5.8V when OVSEL is tied to GND or 13.9V (FPF34891) / 10.4V (FPF34892) when OVSEL is floating.

Channel two (V_{BUS} to BAT) is an active-high, 5 V/6 A rated, power MOSFET, fixed OVP at V_{BUS} is 5.8 V (± 200 mV) and Reverse Current Blocking (RCB) during its OFF State. OVLO at BAT can be programmed by external resistors. The Over-Voltage status will be latched and FLAG will signal the fault by pulling low. To re-start this channel from OVLO, EN2 need to be toggled from LOW to HIGH.

The FPF3489x is available in a 28-bump, 1.67 mm x 2.96 mm Wafer-Level Chip-Scale Package (WL-CSP) with 0.4 mm pitch.

Applications

- Mobile Handsets and Tablets
- Wearable Devices

Ordering Information

Part Number	Operating Temperature Range	Top Mark	Package	Packing Method
FPF34891UCX	-40°C to +85°C	VF	28-Ball, 0.4 mm Pitch WLCSP	Tape & Reel
FPF34892UCX		VG		

Application Diagram

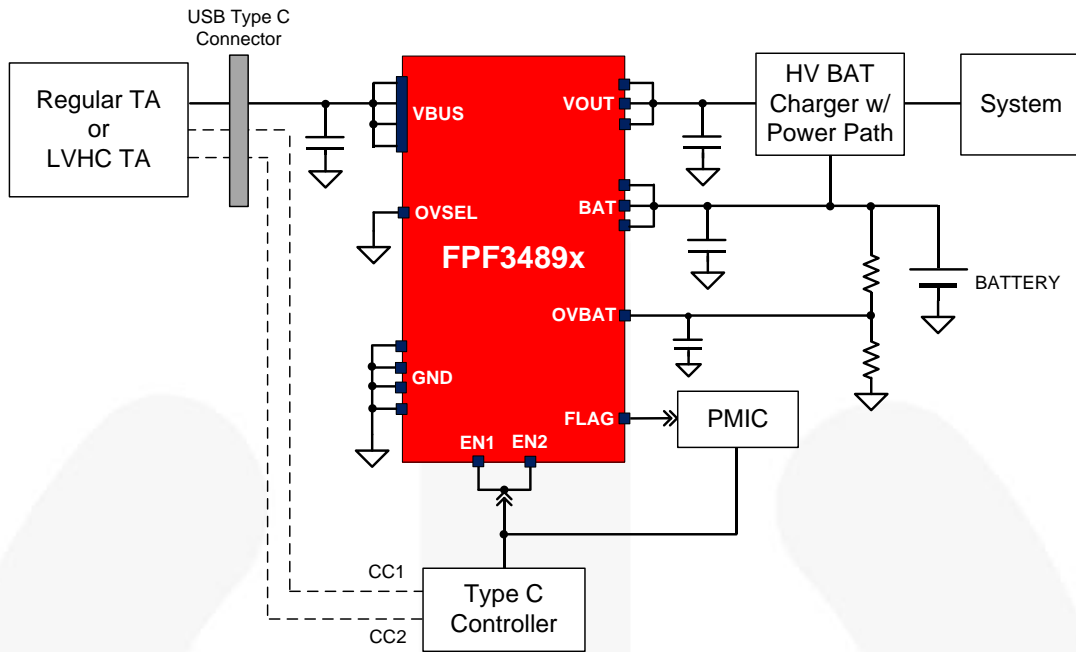

Figure 1. Typical Application

Block Diagram

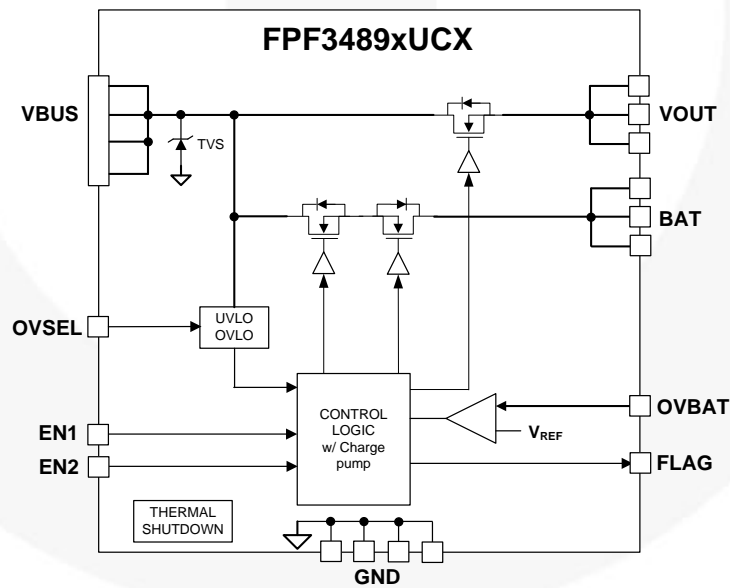

Figure 2. Functional Block Diagram

Pin Configuration

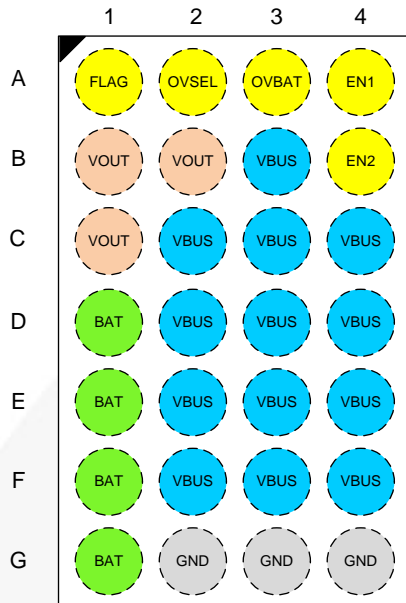

Figure 3. Pin Configuration (Top View)

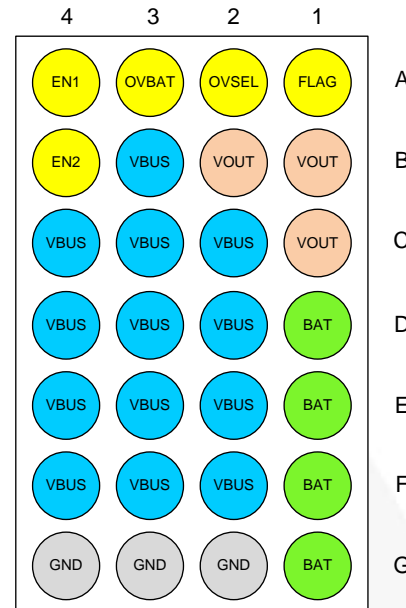

Figure 4. Pin Configuration (Bottom View)

Pin Definitions

Name	Bump	Type	Description
VBUS	B3, C2, C3, C4, D2, D3, D4, E2, E3, E4, F2, F3, F4	Input/Supply	Power Switch Input and Device Supply
VOUT	B1, B2, C1	Output	Power Switch Output to Load
BAT	D1, E1, F1, G1	Output	Power Switch Output to Battery
OVBAT	A3	Input	Over-Voltage Lockout on BAT Adjustment Pin
EN2	B4	Input	Active HIGH. Channel 2, VBUS to BAT path only. Internal pull-down resistor of 1 M Ω is included.
EN1	A4	Input	Active LOW. Channel 1, VBUS to VOUT path only. Internal pull-down resistor of 1 M Ω is included.
OVSEL	A2	Input	OVSEL Floating, OVP 13.9 V (PPF34891) or 10.4 V (PPF34892); OVSEL = GND, OVP 5.8V.
FLAG	A1	Output	Active HIGH PowerGOOD output for VBUS to BAT path. CMOS output requiring no external bias. HIGH: VBUS to BAT path is ON and in normal state. LOW: VBUS to BAT path is OFF due to EN2=LOW, UVLO, OVLO, thermal shutdown or device shutdown
GND	G2, G3, G4	GND	Ground

Absolute Maximum Ratings

Stresses exceeding the absolute maximum ratings may damage the device. The device may not function or be operable above the recommended operating conditions and stressing the parts to these levels is not recommended. In addition, extended exposure to stresses above the recommended operating conditions may affect device reliability. The absolute maximum ratings are stress ratings only.

Symbol	Parameters		Min.	Max.	Unit
V _{BUS}	V _{BUS} to GND & V _{BUS} to V _{OUT} = GND or Float		-2 ⁽¹⁾	28	V
V _{OUT}	V _{OUT} to GND		-0.3	V _{BUS} +0.3	V
BAT	BAT to GND		-0.3	6.0	V
OVBAT	OVBAT to GND			6	V
V _{EN(n)_OVSEL_FLAG}	EN(n), OVSEL or FLAG to GND			6	V
I _{IN_VBUS_VOUT}	Continuous V _{BUS} to V _{OUT} Current			3.5	A
	Peak V _{BUS} to V _{OUT} Current (5 ms)			7	A
I _{IN_VBUS_BAT}	Continuous V _{BUS} to BAT Current			6	A
	Peak V _{BUS} to BAT Current (5 ms)			12	A
t _{PD}	Total Power Dissipation at T _A =25°C			2.27	W
T _{STG}	Storage Junction Temperature		-65	+150	°C
T _J	Operating Junction Temperature			+150	°C
T _L	Lead Temperature (Soldering, 10 Seconds)			+260	°C
θ _{JA}	Thermal Resistance, Junction-to-Ambient (1in. ² pad of 2 oz. copper)			55 ⁽²⁾	°C/W
ESD	Electrostatic Discharge Capability	Human Body Model, ANSI/ESDA/JEDEC JS-001	2		kV
		Charged Device Model, JESD22-C101	1		
	IEC61000-4-2 System Level	Air Discharge	15		
		Contact Discharge	8		
Surge	IEC 61000-4-5	V _{BUS}	±100		V

Notes:

1. Pulsed, 50 ms maximum non-repetitive.
2. Measured using 2S2P JEDEC std. PCB.

Recommended Operating Conditions

The Recommended Operating Conditions table defines the conditions for actual device operation. Recommended operating conditions are specified to ensure optimal performance to the datasheet specifications. Fairchild does not recommend exceeding them or designing to Absolute Maximum Ratings.

Symbol	Parameter	Min.	Max.	Unit
V _{BUS}	Supply Voltage	2.7	13.5	V
C _{IN} / C _{OUT}	Input and Output Capacitance	0.1		μF
C _{BAT}	BAT Capacitance	47		μF
T _A	Operating Temperature	-40	+85	°C

Electrical Characteristics

Unless otherwise noted, $V_{BUS} = 2.7$ to 13.5 V, $T_A = -40$ to 85°C ; Typical values are at $V_{BUS} = 5$ V, $I_{IN} \leq 2$ A, $C_{IN} = 0.1\ \mu\text{F}$ and $T_A = 25^\circ\text{C}$.

Symbol	Parameter	Conditions	Min.	Typ.	Max.	Unit
Basic Operation						
I_Q	Input Quiescent Current	$V_{BUS} = 5$ V, $EN1=EN2=LOW$		145	215	μA
I_{IN_Q}	OVLO Supply Current	$V_{BUS} = 15$ V, $V_{OUT} = 0$ V, $EN1=EN2=LOW$		190	290	μA
		$V_{BUS} = 5.5$ V, $BAT = 0$ V, $EN1=EN2=HIGH$		150	210	μA
V_{BUS_CLAMP}	Input Clamping Voltage	$I_{IN}=10$ mA		35		V
V_{BUS_UVLO}	Under-Voltage Trip Level	VBUS Rising, $T_A = -40$ to 85°C	2.35	2.5	2.65	V
		VBUS Falling, $T_A = -40$ to 85°C	2.20	2.35	2.50	V
T_{SDN}	Thermal Shutdown ⁽³⁾			150		$^\circ\text{C}$
T_{SDN_HYS}	Thermal Shutdown Hysteresis ⁽³⁾			20		$^\circ\text{C}$
VBUS to VOUT Switch (Channel 1)						
V_{CH1_OVP}	Over-Voltage Trip Level (OVSEL Floating)	VBUS Rising (PPF34891)	13.5	13.9	14.3	V
		VBUS Falling (PPF34891)		13.6		
		VBUS Rising (PPF34892)	10.0	10.4	10.8	
		VBUS Falling (PPF34892)		10.1		
	Over-Voltage Trip Level (OVSEL = GND)	VBUS Rising	5.6	5.8	6.0	
		VBUS Falling		5.65		
R_{ON_VOUT}	On-Resistance	$V_{BUS} = 5$ V, $I_{OUT} = 1$ A, $T_A = 25^\circ\text{C}$		28	39	m Ω
		$V_{BUS} = 12$ V, $I_{OUT} = 1$ A, $T_A = 25^\circ\text{C}$		28	39	m Ω
t_{DEB_VOUT}	Debounce Time	Time from $V_{BUS_UVLO} < V_{BUS} < V_{BUS_OVLO}$ to $V_{OUT} = 0.1 \times V_{BUS}$		15		ms
t_{ON_VOUT}	Switch Turn-On Time	$R_L = 100\ \Omega$, $C_L = 10\ \mu\text{F}$, V_{OUT} from $0.1 \times V_{BUS}$ to $0.9 \times V_{BUS}$		2		ms
t_{OFF_VOUT}	Switch Turn-Off Time ⁽³⁾	$R_L = 100\ \Omega$, No C_L , $V_{BUS} > V_{OUT_OVLO}$ to $V_{OUT} = 0.9 \times V_{BUS}$			150	ns
VBUS to BAT Switch (Channel 2)						
V_{CH2_OVP}	Over-Voltage Trip Level for VBUS monitor	VBUS Rising, $T_A = -40$ to 85°C	5.6	5.8	6.0	V
		VBUS Falling, $T_A = -40$ to 85°C		5.65		V
V_{OVLO_TH}	BAT OVP set Threshold	$OVBAT = 0$ V to V_{OVLO} , $T_A = 0$ to 85°C	1.145	1.155	1.165	V
		$OVBAT = 0$ V to V_{OVLO} , $T_A = -40$ to 85°C	1.140	1.155	1.165	
R_{ON_BAT}	On-Resistance	$V_{BUS} = 3$ V, $I_{OUT} = 1$ A, $T_A = 25^\circ\text{C}$		33	40	m Ω
I_{RCB}	Reverse Current	$V_{BUS} = 0$ V, $BAT = 4.4$ V			1	μA
t_{DEB_BAT}	Debounce Time	Time from $V_{BUS_UVLO} < V_{BUS} < V_{BUS_OVLO}$ to $BAT = 0.1 \times V_{BUS}$		15		ms
t_{BAT_START}	Soft-Start Time	Time from $V_{BUS} = V_{BUS_UVLO}$ to $0.1 \times FLAG$		30		ms
t_{ON_BAT}	Switch Turn-On Time	$R_L = 100\ \Omega$, $C_L = 10\ \mu\text{F}$, V_{OUT} from $0.1 \times V_{BUS}$ to $0.9 \times V_{BUS}$		2.5		ms

Electrical Characteristics

Unless otherwise noted, $V_{BUS} = 2.7$ to 13.5 V, $T_A = -40$ to 85°C ; Typical values are at $V_{BUS} = 5$ V, $I_{IN} \leq 2$ A, $C_{IN} = 0.1\ \mu\text{F}$ and $T_A = 25^\circ\text{C}$.

Symbol	Parameter	Conditions	Min.	Typ.	Max.	Unit
$t_{\text{OFF_BAT}}$	Switch Turn-Off Time ⁽³⁾	$R_L = 100\ \Omega$, No C_L , $V_{BUS} > V_{\text{BAT_OV\text{BAT}}} \text{ to } \text{BAT} = 0.9 \times V_{BUS}$			150	ns
Digital Signals						
V_{OH}	FLAG Output HIGH Voltage	$V_{BUS} = 5$ V, $\text{EN}2 = \text{LOW}$	1.6	1.8	2.0	V
V_{OL}	FLAG Output LOW Voltage	$V_{BUS} = 5$ V, $\text{EN}2 = \text{HIGH}$			0.5	V
$R_{\text{PD_EN}(n)}$	Internal Pull-Down Resistor at $\text{EN}1$ and $\text{EN}2$			1		$\text{M}\Omega$
$R_{\text{PU_OVSEL}}$	Internal Pull-Up Resistor at OVSEL			1		$\text{M}\Omega$
$V_{\text{IH_EN}(n)_OVSEL}$	Logic Enable HIGH Voltage	V_{BUS} Operating Range	1.2			V
$V_{\text{IL_EN}(n)_OVSEL}$	Logic Enable LOW Voltage	V_{BUS} Operating Range			0.5	V
$I_{\text{OVSEL_EN}(n)_LEAK}$	OVSEL and $\text{EN}(n)$ Leakage Current	$V_{BUS} = 5$ V, V_{OUT} , $\text{BAT} = \text{Floating}$		5	7	μA

Note:

- Guaranteed by characterization and design.

Timing Diagrams

VBUS to VOUT Path

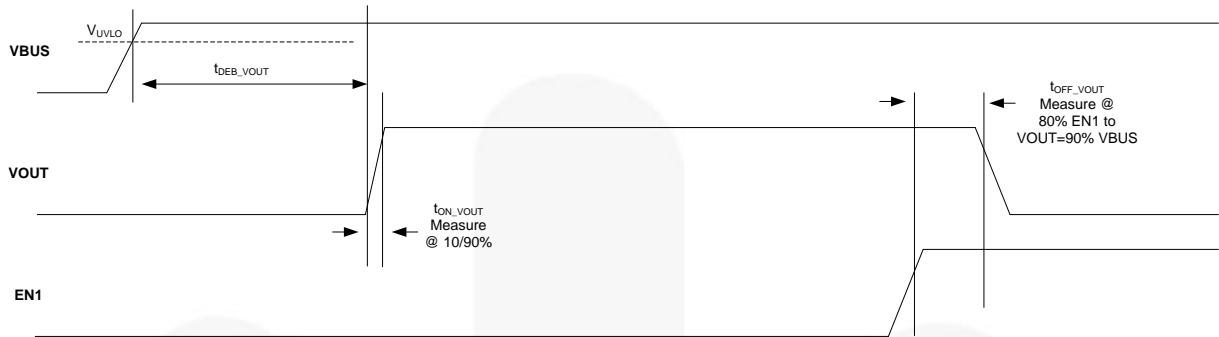

Figure 5. Timing for VBUS to VOUT Power Up/Down and Normal Operation

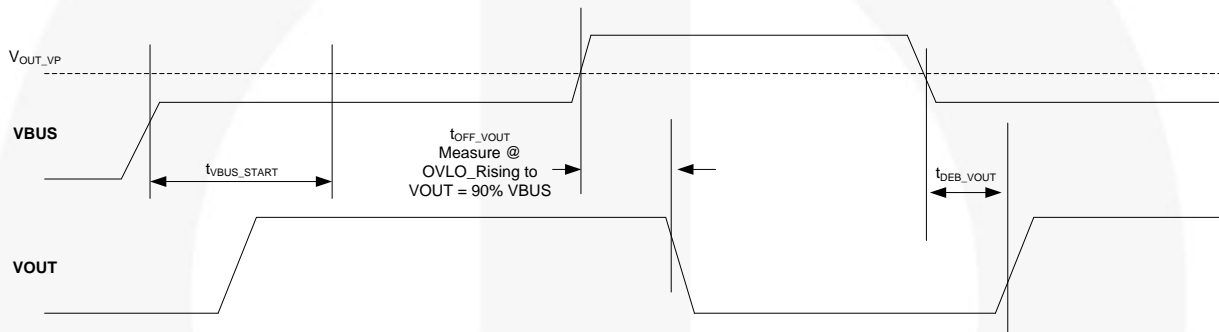

Figure 6. Timing for VBUS to VOUT OVLO Operation (EN1=LOW)

VBUS to BAT Path

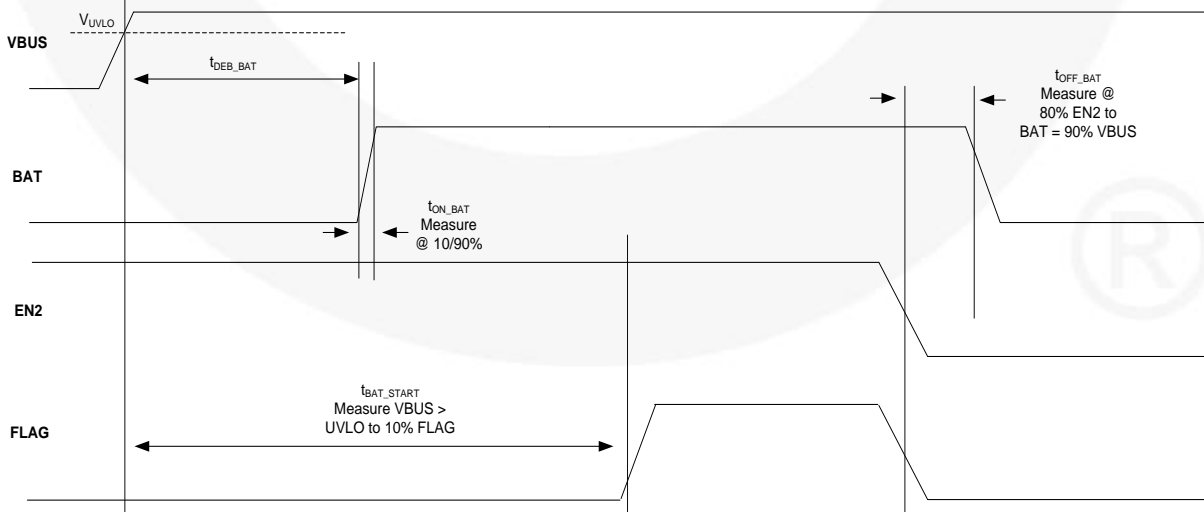

Figure 7. Timing for VBUS to BAT Power Up/Down and Normal Operation

Timing Diagrams (Continued)

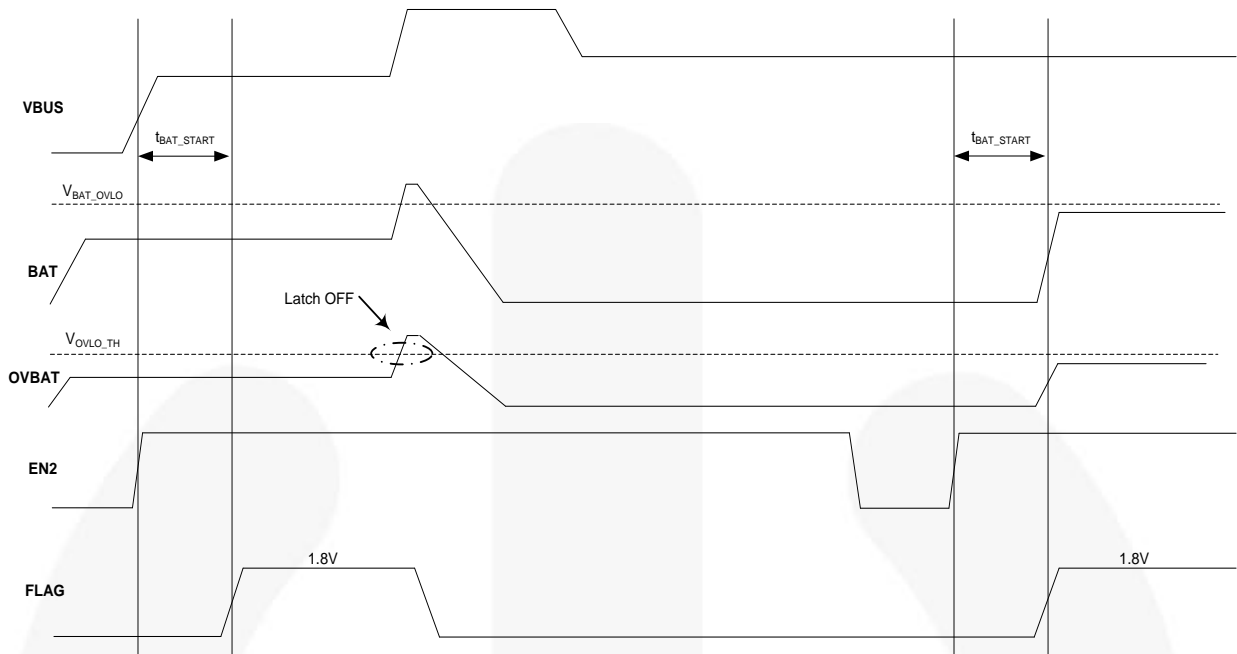

Figure 8. Timing for VBUS to BAT OVLO Operation (EN2=HIGH)

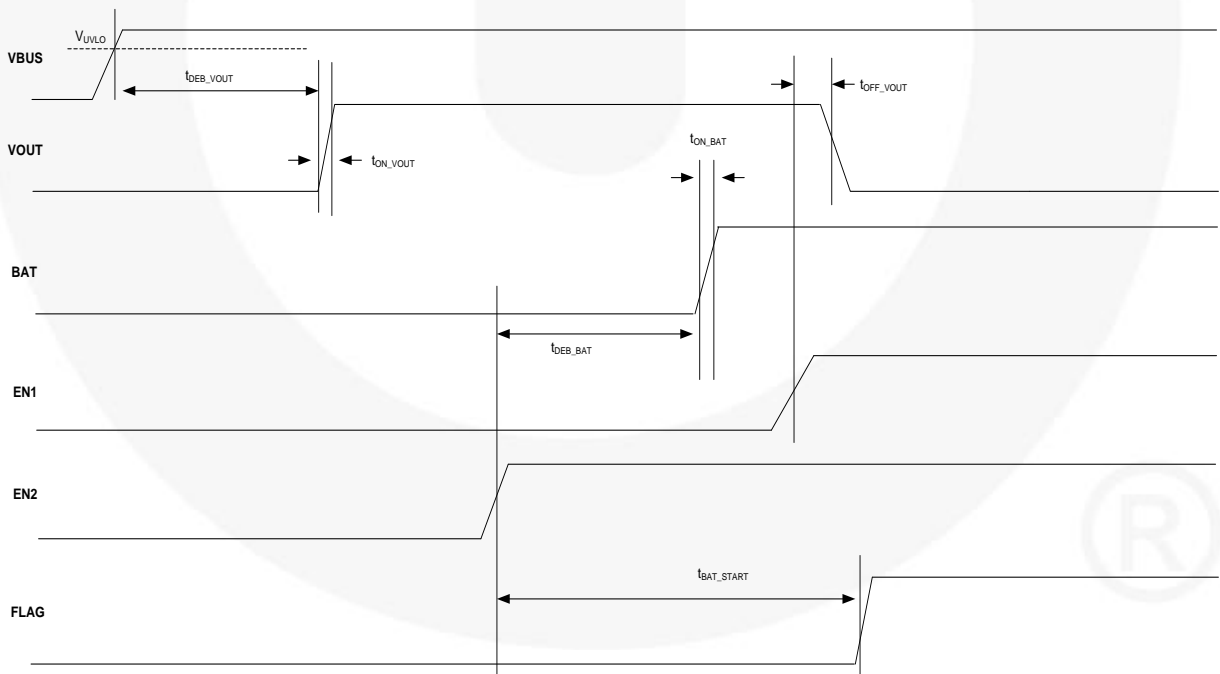

Figure 9. Timing for Overall ON/OFF Operation

Operation and Application Description

Input Capacitor

To limit the voltage drop on the input supply caused by transient inrush current when the switches turns, a capacitor must be placed in between the VBUS and GND pins. A high-value capacitor on C_{IN} can be used to reduce the voltage drop in high-current applications.

Under-Voltage Lockout (UVLO)

The under-voltage lockout turns the switches off if the input voltage drops below the lockout threshold. With the enable pins, EN1 & EN2, active, the input voltage rising above the UVLO threshold releases the lockout and enables the switches.

Thermal Shutdown

The thermal shutdown protects the die from internally or externally generated excessive temperature. During an over-temperature condition, the switch is turned off. The switch automatically turns on again if the temperature of the die drops below the threshold temperature.

FLAG Reporting

To indicate the status of channel 2, push-pull output FLAG signal high (typical 1.8V) when channel 2 is turned on. FLAG will output low when channel 2 is turned off.

Over-Voltage Lockout

To protect the system, FPF3489x provide multi level over voltage protection.

For channel 1 (VBUS to VOUT), 3 different levels can be chosen. When OVSEL is tied to GND, OVP will be triggered once VBUS voltage is higher than typical 5.8V. With OVSEL floating, OVP will be triggered when VBUS voltage is higher than typical 13.9V (FPF34891) or 10.4V (FPF34892). FLAG voltage will output low until the over voltage condition disappears.

For channel 2 (VBUS to BAT), both VBUS and BAT voltage will be monitored. Once VBUS voltage is higher than typical 5.8V, channel 2 will be turned off and output low at FLAG pin until VBUS drop below 5.65V (typical). Once BAT voltage is higher than pre-set value (set by external resistors), channel 2 will be turned off and output low at FLAG pin. This status will be latched even after BAT voltage drop to lower than OVP value. To re-active the switch, EN2 need to be toggled.

The OVLO level on BAT can be pre-set by connecting external resistor ladder to the OVBAT pin. Equation (1) can produce the desired trip voltage and resistor values.

$$V_{BAT_OVLO} = V_{OVLO_TH} \times [1 + R1/R2] \quad (1)$$

Recommended minimum $R1 = 1 \text{ M}\Omega$ to reduce leakage and screen unexpected glitch.

The following information applies to the WL-CSP package dimensions on the next page:

Product-Specific Dimensions

D	E	X	Y
2960 $\mu\text{m} \pm 30 \mu\text{m}$	1670 $\mu\text{m} \pm 30 \mu\text{m}$	235 $\mu\text{m} \pm 18 \mu\text{m}$	280 $\mu\text{m} \pm 18 \mu\text{m}$

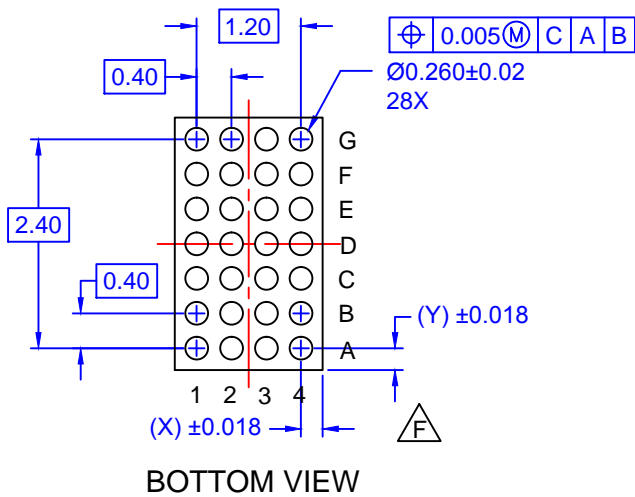
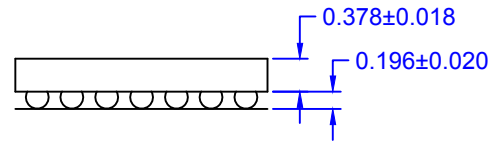
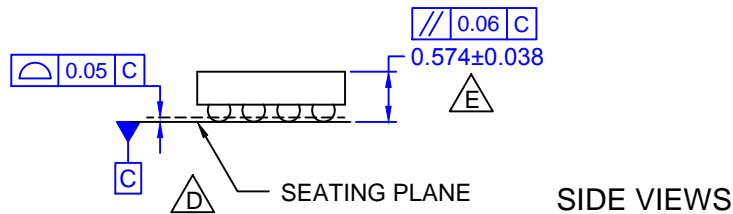
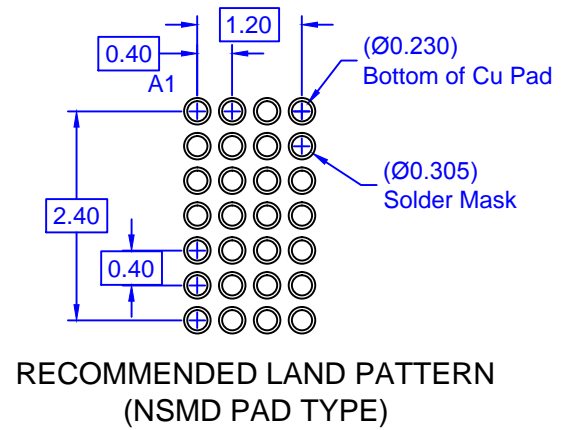
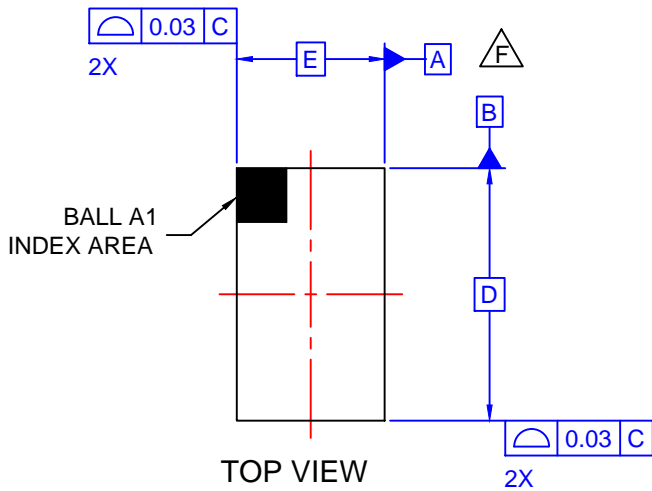

NOTES

- A. NO JEDEC REGISTRATION APPLIES.
- B. DIMENSIONS ARE IN MILLIMETERS.
- C. DIMENSIONS AND TOLERANCE PER ASMEY14.5M, 2009.
- D. DATUM C IS DEFINED BY THE SPHERICAL CROWNS OF THE BALLS.
- E. PACKAGE NOMINAL HEIGHT IS 574 ± 38 MICRONS (536-612 MICRONS).
- F. FOR DIMENSIONS D, E, X, AND Y SEE PRODUCT DATASHEET.
- G. DRAWING FILENAME: MKT-UC028AB REV1.





TRADEMARKS

The following includes registered and unregistered trademarks and service marks, owned by Fairchild Semiconductor and/or its global subsidiaries, and is not intended to be an exhaustive list of all such trademarks.

- AccuPower™
- AttitudeEngine™
- Awinda®
- AX-CAP®*
- BitSiC™
- Build it Now™
- CorePLUS™
- CorePOWER™
- CROSSVOL™
- CTL™
- Current Transfer Logic™
- DEUXPEED®
- Dual Cool™
- EcoSPARK®
- EfficientMax™
- ESBC™
- F**™
- Fairchild®
- Fairchild Semiconductor®
- FACT Quiet Series™
- FACT®
- FastvCore™
- FETBench™
- FPS™
- F-PFS™
- FRFET®
- Global Power ResourceSM
- GreenBridge™
- Green FPS™
- Green FPS™ e-Series™
- Gmax™
- GTO™
- IntelliMAX™
- ISOPLANAR™
- Making Small Speakers Sound Louder and Better™
- MegaBuck™
- MICROCOUPLER™
- MicroFET™
- MicroPak™
- MicroPak2™
- MillerDrive™
- MotionMax™
- MotionGrid®
- MTi®
- MTx®
- MVN®
- mWSaver®
- OptoHiT™
- OPTOLOGIC®
- OPTOPLANAR®
- ®
- Power Supply WebDesigner™
- PowerTrench®
- PowerXS™
- Programmable Active Droop™
- QFET®
- QS™
- Quiet Series™
- RapidConfigure™
- ™
- Saving our world, 1mW/W/kW at a time™
- SignalWise™
- SmartMax™
- SMART START™
- Solutions for Your Success™
- SPM®
- STEALTH™
- SuperFET®
- SuperSOT™-3
- SuperSOT™-6
- SuperSOT™-8
- SupreMOS®
- SyncFET™
- Sync-Lock™
- ®
- TinyBoost®
- TinyBuck®
- TinyCalc™
- TinyLogic®
- TINYOPTO™
- TinyPower™
- TinyPWM™
- TinyWire™
- TranSiC™
- TriFault Detect™
- TRUECURRENT®*
- μSerDes™
- ™
- UHC®
- Ultra FRFET™
- UniFET™
- VcX™
- VisualMax™
- VoltagePlus™
- XS™
- Xsens™
- 仙童®

* Trademarks of System General Corporation, used under license by Fairchild Semiconductor.

DISCLAIMER

FAIRCHILD SEMICONDUCTOR RESERVES THE RIGHT TO MAKE CHANGES WITHOUT FURTHER NOTICE TO ANY PRODUCTS HEREIN TO IMPROVE RELIABILITY, FUNCTION, OR DESIGN. TO OBTAIN THE LATEST, MOST UP-TO-DATE DATASHEET AND PRODUCT INFORMATION, VISIT OUR WEBSITE AT [HTTP://WWW.FAIRCHILDSEMI.COM](http://www.fairchildsemi.com). FAIRCHILD DOES NOT ASSUME ANY LIABILITY ARISING OUT OF THE APPLICATION OR USE OF ANY PRODUCT OR CIRCUIT DESCRIBED HEREIN; NEITHER DOES IT CONVEY ANY LICENSE UNDER ITS PATENT RIGHTS, NOR THE RIGHTS OF OTHERS. THESE SPECIFICATIONS DO NOT EXPAND THE TERMS OF FAIRCHILD'S WORLDWIDE TERMS AND CONDITIONS, SPECIFICALLY THE WARRANTY THEREIN, WHICH COVERS THESE PRODUCTS.

AUTHORIZED USE

Unless otherwise specified in this data sheet, this product is a standard commercial product and is not intended for use in applications that require extraordinary levels of quality and reliability. This product may not be used in the following applications, unless specifically approved in writing by a Fairchild officer: (1) automotive or other transportation, (2) military/aerospace, (3) any safety critical application – including life critical medical equipment – where the failure of the Fairchild product reasonably would be expected to result in personal injury, death or property damage. Customer's use of this product is subject to agreement of this Authorized Use policy. In the event of an unauthorized use of Fairchild's product, Fairchild accepts no liability in the event of product failure. In other respects, this product shall be subject to Fairchild's Worldwide Terms and Conditions of Sale, unless a separate agreement has been signed by both Parties.

ANTI-COUNTERFEITING POLICY

Fairchild Semiconductor Corporation's Anti-Counterfeiting Policy. Fairchild's Anti-Counterfeiting Policy is also stated on our external website, www.fairchildsemi.com, under Terms of Use

Counterfeiting of semiconductor parts is a growing problem in the industry. All manufacturers of semiconductor products are experiencing counterfeiting of their parts. Customers who inadvertently purchase counterfeit parts experience many problems such as loss of brand reputation, substandard performance, failed applications, and increased cost of production and manufacturing delays. Fairchild is taking strong measures to protect ourselves and our customers from the proliferation of counterfeit parts. Fairchild strongly encourages customers to purchase Fairchild parts either directly from Fairchild or from Authorized Fairchild Distributors who are listed by country on our web page cited above. Products customers buy either from Fairchild directly or from Authorized Fairchild Distributors are genuine parts, have full traceability, meet Fairchild's quality standards for handling and storage and provide access to Fairchild's full range of up-to-date technical and product information. Fairchild and our Authorized Distributors will stand behind all warranties and will appropriately address any warranty issues that may arise. Fairchild will not provide any warranty coverage or other assistance for parts bought from Unauthorized Sources. Fairchild is committed to combat this global problem and encourage our customers to do their part in stopping this practice by buying direct or from authorized distributors.

PRODUCT STATUS DEFINITIONS

Definition of Terms

Datasheet Identification	Product Status	Definition
Advance Information	Formative / In Design	Datasheet contains the design specifications for product development. Specifications may change in any manner without notice.
Preliminary	First Production	Datasheet contains preliminary data; supplementary data will be published at a later date. Fairchild Semiconductor reserves the right to make changes at any time without notice to improve design.
No Identification Needed	Full Production	Datasheet contains final specifications. Fairchild Semiconductor reserves the right to make changes at any time without notice to improve the design.
Obsolete	Not In Production	Datasheet contains specifications on a product that is discontinued by Fairchild Semiconductor. The datasheet is for reference information only.

Rev. I77

Mouser Electronics

Authorized Distributor

Click to View Pricing, Inventory, Delivery & Lifecycle Information:

[Fairchild Semiconductor:](#)

[FPF34892UCX](#)