

Applications

- High Frequency Isolated DC-DC Converters with Synchronous Rectification for Telecom and Industrial Use
- High Frequency Buck Converters for Server Processor Power Synchronous FET
- Optimized for Synchronous Buck Converters Including Capacitive Induced Turn-on Immunity
- 100% R_G Tested

Benefits

- Ultra-Low Gate Impedance
- Very Low R_{DS(on)} at 4.5V V_{GS}
- Fully Characterized Avalanche Voltage and Current

HEXFET® Power MOSFET

V_{DSS}	R_{DS(on)} max	I_D
20V	6.5mΩ	110A^④

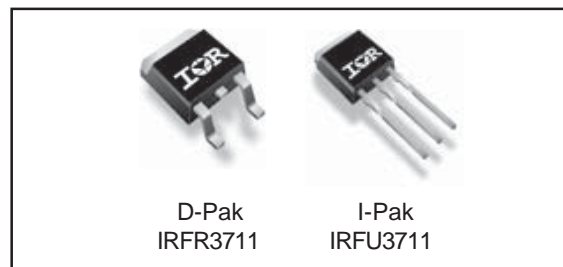

Absolute Maximum Ratings

Symbol	Parameter	Max	Units
V _{DS}	Drain-Source Voltage	20	V
V _{GS}	Gate-Source Voltage	± 20	
I _D @ T _C = 25°C	Continuous Drain Current, V _{GS} @ 10V	100 ^④	A
I _D @ T _C = 100°C	Continuous Drain Current, V _{GS} @ 10V	69 ^④	
I _{DM}	Pulsed Drain Current ^①	440	
P _D @ T _A = 25°C	Maximum Power Dissipation ^⑤	2.5	W
P _D @ T _C = 25°C	Maximum Power Dissipation	120	
	Linear Derating Factor	0.96	W/°C
T _J , T _{STG}	Junction and Storage Temperature Range	-55 to +150	°C

Thermal Resistance

Symbol	Parameter	Typ	Max	Units
R _{θJC}	Junction-to-Case ^⑥	—	1.04	°C/W
R _{θJA}	Junction-to-Ambient (PCB Mount) ^{⑤⑥}	—	50	
R _{θJA}	Junction-to-Ambient ^⑥	—	110	

Notes ^① through ^⑥ are on page 10

IRFR/U3711

Static @ $T_J = 25^\circ\text{C}$ (unless otherwise specified)

International
IR Rectifier

Symbol	Parameter	Min	Typ	Max	Units	Conditions
$V_{(BR)DSS}$	Drain-to-Source Breakdown Voltage	20	—	—	V	$V_{GS} = 0V, I_D = 250\mu A$
$\Delta V_{(BR)DSS}/\Delta T_J$	Breakdown Voltage Temp. Coefficient	—	0.022	—	V/ $^\circ\text{C}$	Reference to $25^\circ\text{C}, I_D = 1\text{mA}$
$R_{DS(on)}$	Static Drain-to-Source On-Resistance	—	5.2	6.5	m Ω	$V_{GS} = 10V, I_D = 15A$ ③
		—	6.7	8.5		$V_{GS} = 4.5V, I_D = 12A$ ③
$V_{GS(th)}$	Gate Threshold Voltage	1.0	—	3.0	V	$V_{DS} = V_{GS}, I_D = 250\mu A$
I_{DSS}	Drain-to-Source Leakage Current	—	—	140	μA	$V_{DS} = 20V, V_{GS} = 0V$
		—	—	20		$V_{DS} = 16V, V_{GS} = 0V$
		—	—	100		$V_{DS} = 16V, V_{GS} = 0V, T_J = 125^\circ\text{C}$
I_{GSS}	Gate-to-Source Forward Leakage	—	—	200	nA	$V_{GS} = 20V$
	Gate-to-Source Reverse Leakage	—	—	-200		$V_{GS} = -20V$

Dynamic @ $T_J = 25^\circ\text{C}$ (unless otherwise specified)

Symbol	Parameter	Min	Typ	Max	Units	Conditions
g_{fs}	Forward Transconductance	53	—	—	S	$V_{DS} = 16V, I_D = 30A$
Q_g	Total Gate Charge	—	29	44	nC	$I_D = 15A$ $V_{DS} = 10V$ $V_{GS} = 4.5V$ ③ $V_{GS} = 0V, V_{DS} = 10V$
Q_{gs}	Gate-to-Source Charge	—	7.3	—		
Q_{gd}	Gate-to-Drain ("Miller") Charge	—	8.9	—		
Q_{oss}	Output Gate Charge	—	33	—		
R_G	Gate Resistance	0.3	—	2.5	Ω	
$t_{d(on)}$	Turn-On Delay Time	—	12	—	ns	$V_{DD} = 10V$ $I_D = 30A$ $R_G = 1.8\Omega$ $V_{GS} = 4.5V$ ③
t_r	Rise Time	—	220	—		
$t_{d(off)}$	Turn-Off Delay Time	—	17	—		
t_f	Fall Time	—	12	—		
C_{iss}	Input Capacitance	—	2980	—	pF	$V_{GS} = 0V$ $V_{DS} = 10V$ $f = 1.0\text{MHz}$
C_{oss}	Output Capacitance	—	1770	—		
C_{riss}	Reverse Transfer Capacitance	—	280	—		

Avalanche Characteristics

Symbol	Parameter	Typ	Max	Units
E_{AS}	Single Pulse Avalanche Energy ②	—	460	mJ
I_{AR}	Avalanche Current ①	—	30	A

Diode Characteristics

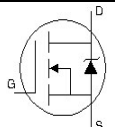
Symbol	Parameter	Min	Typ	Max	Units	Conditions
I_S	Continuous Source Current (Body Diode)	—	—	110 ④	A	MOSFET symbol showing the integral reverse p-n junction diode. 
I_{SM}	Pulsed Source Current (Body Diode) ①	—	—	440		
V_{SD}	Diode Forward Voltage	—	0.88	1.3	V	$T_J = 25^\circ\text{C}, I_S = 30A, V_{GS} = 0V$ ③
		—	0.82	—		$T_J = 125^\circ\text{C}, I_S = 30A, V_{GS} = 0V$ ③
t_{rr}	Reverse Recovery Time	—	50	75	ns	$T_J = 25^\circ\text{C}, I_F = 16A, V_R = 10V$
Q_{rr}	Reverse Recovery Charge	—	61	92	nC	$di/dt = 100A/\mu s$ ③
t_{rr}	Reverse Recovery Time	—	48	72	ns	$T_J = 125^\circ\text{C}, I_F = 16A, V_R = 10V$
Q_{rr}	Reverse Recovery Charge	—	65	98	nC	$di/dt = 100A/\mu s$ ③

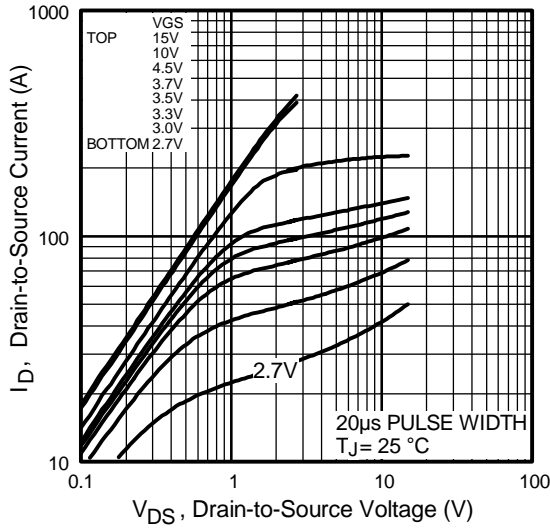

Fig 1. Typical Output Characteristics

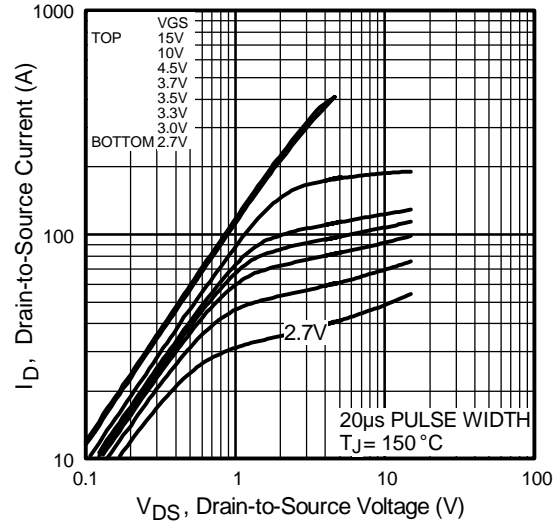

Fig 2. Typical Output Characteristics

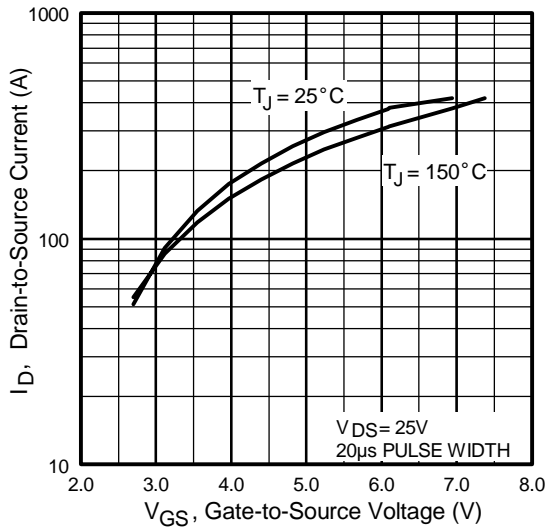

Fig 3. Typical Transfer Characteristics

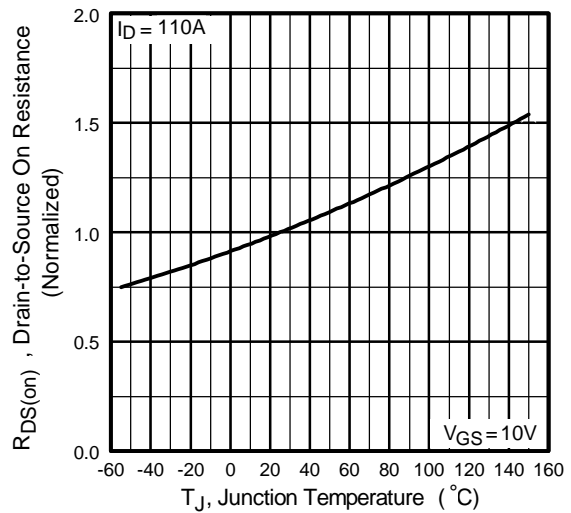

Fig 4. Normalized On-Resistance Vs. Temperature

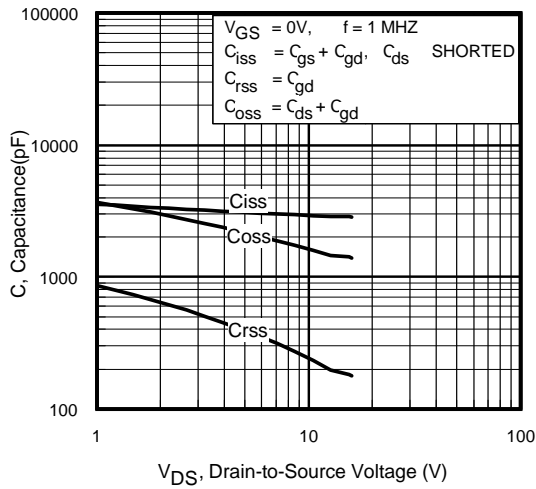

Fig 5. Typical Capacitance Vs. Drain-to-Source Voltage

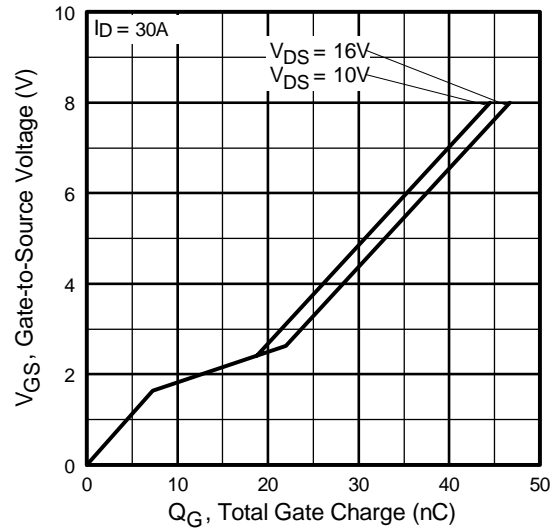

Fig 6. Typical Gate Charge Vs. Gate-to-Source Voltage

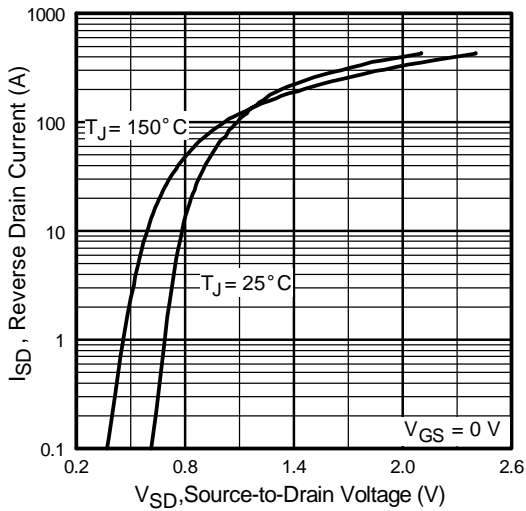

Fig 7. Typical Source-Drain Diode Forward Voltage

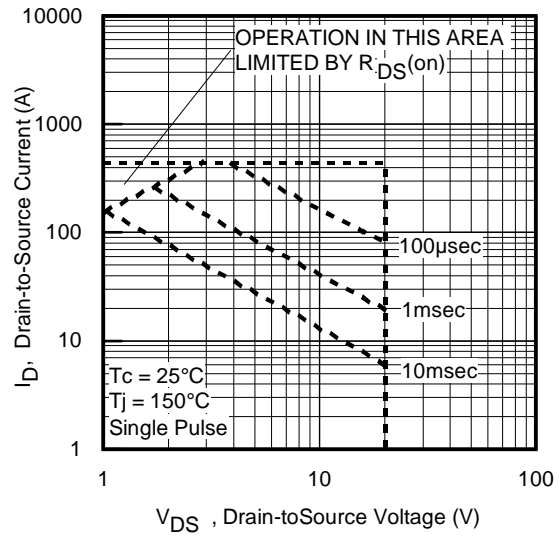

Fig 8. Maximum Safe Operating Area

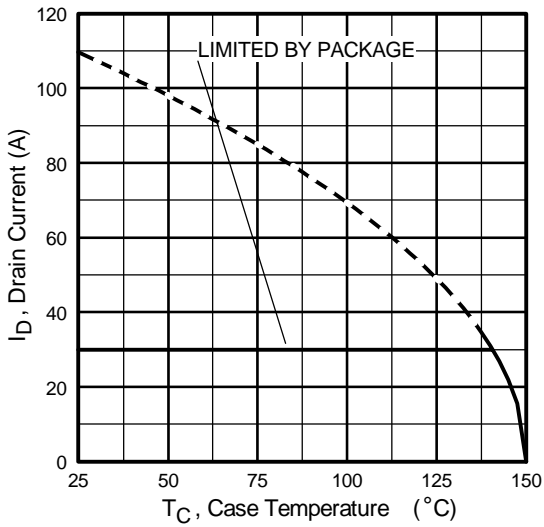

Fig 9. Maximum Drain Current Vs. Case Temperature

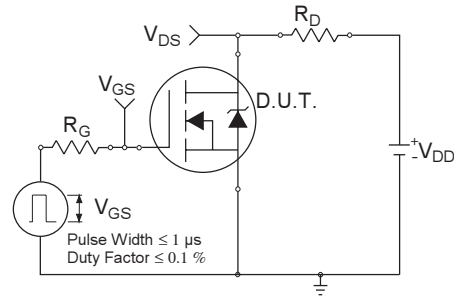

Fig 10a. Switching Time Test Circuit



Fig 10b. Switching Time Waveforms

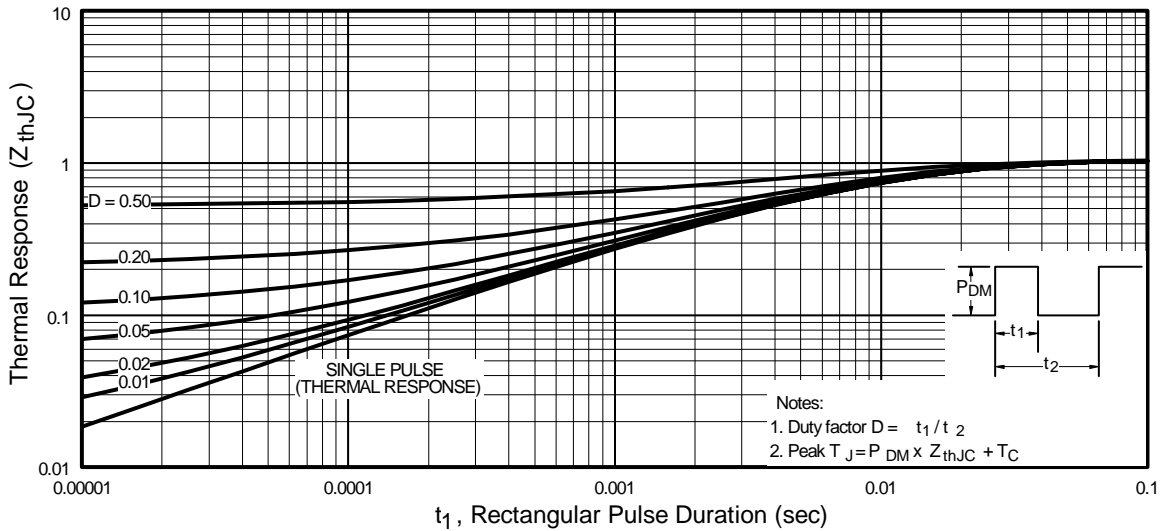

Fig 11. Maximum Effective Transient Thermal Impedance, Junction-to-Case

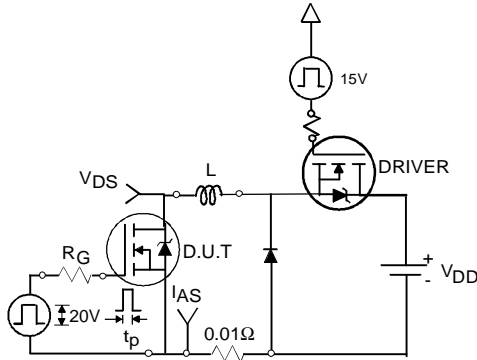

Fig 12a. Unclamped Inductive Test Circuit



Fig 12b. Unclamped Inductive Waveforms

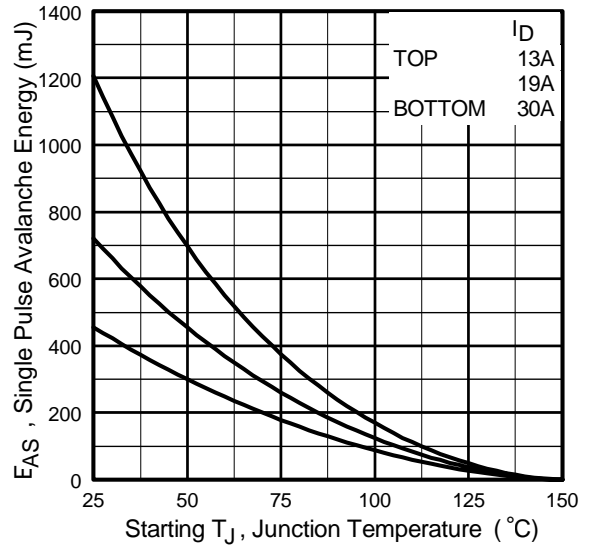

Fig 12c. Maximum Avalanche Energy Vs. Drain Current

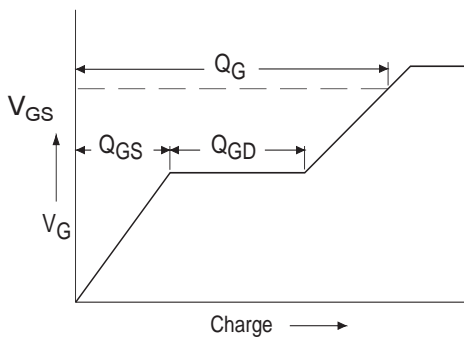

Fig 13a. Basic Gate Charge Waveform

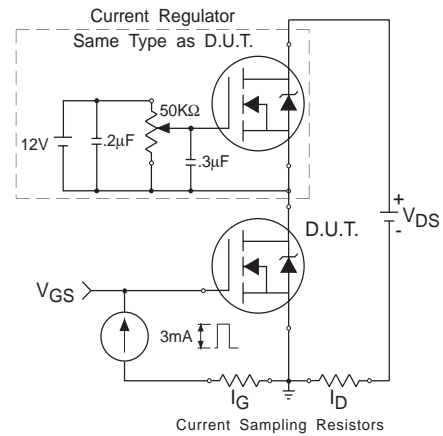
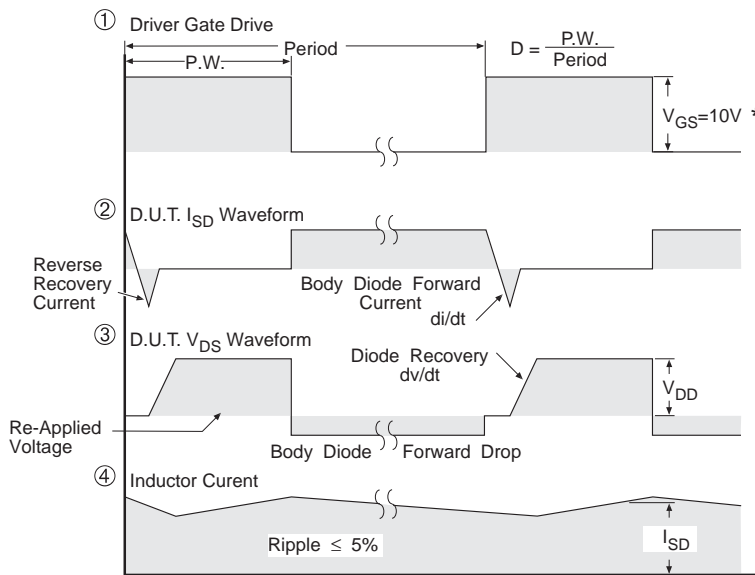
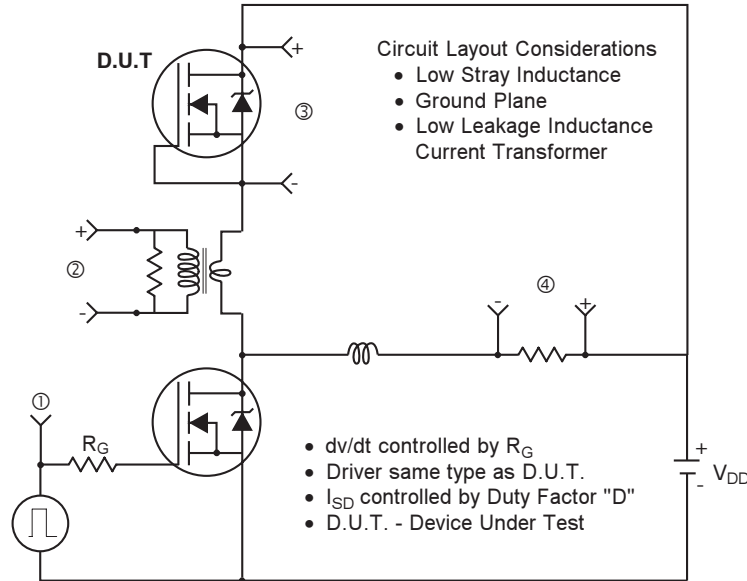

Fig 13b. Gate Charge Test Circuit

Peak Diode Recovery dv/dt Test Circuit



* $V_{GS} = 5V$ for Logic Level Devices

Fig 14. For N-Channel HEXFET® Power MOSFETs

IRFR/U3711



D-Pak (TO-252AA) Package Outline

Dimensions are shown in millimeters (inches)

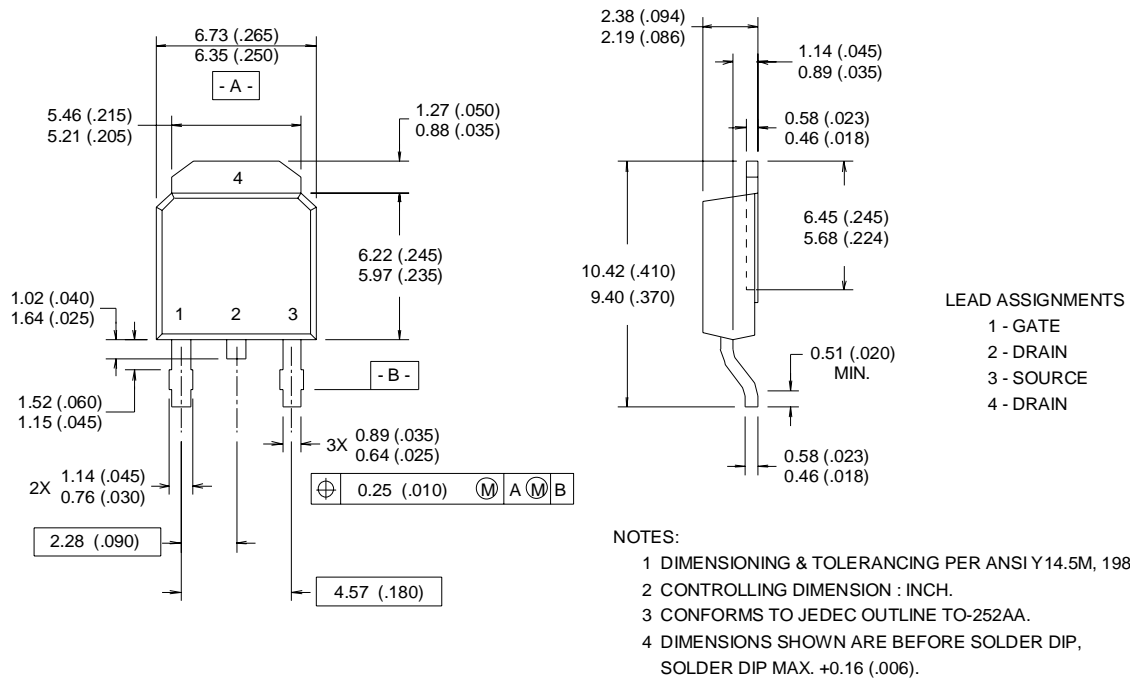

D-Pak (TO-252AA) Part Marking Information

EXAMPLE: THIS IS AN IRFR120
 LOT CODE 1789
 ASSEMBLED ON WW 19, 1997
 IN THE ASSEMBLY LINE "C"

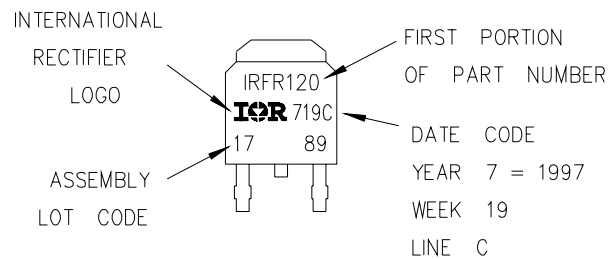

I-Pak (TO-251AA) Package Outline

Dimensions are shown in millimeters (inches)

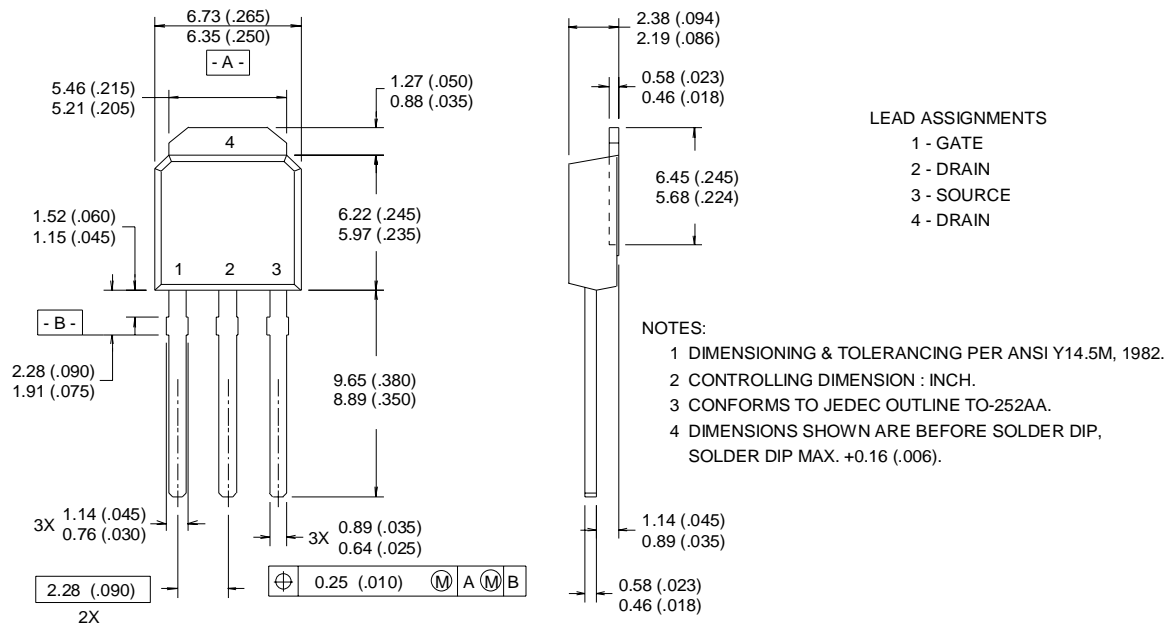

I-Pak (TO-251AA) Part Marking Information

EXAMPLE: THIS IS AN IRFU120
 LOT CODE 1789
 ASSEMBLED ON WW 19, 1997
 IN THE ASSEMBLY LINE "C"

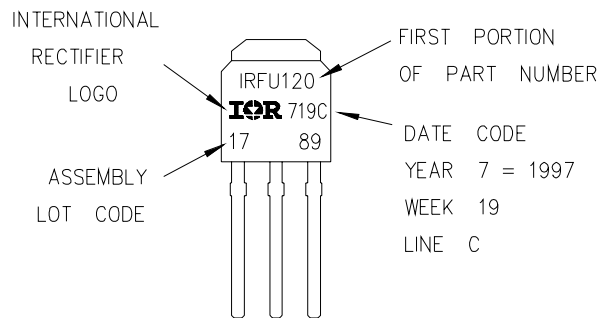

IRFR/U3711

International
IR Rectifier

D-Pak (TO-252AA) Tape & Reel Information

Dimensions are shown in millimeters (inches)

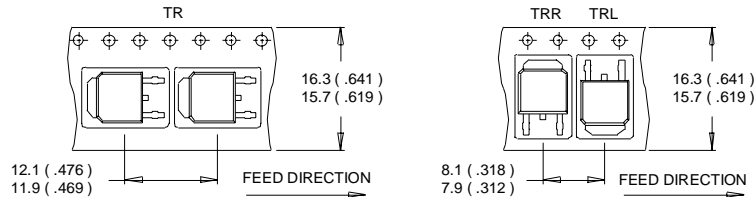

NOTES :

1. CONTROLLING DIMENSION : MILLIMETER.
2. ALL DIMENSIONS ARE SHOWN IN MILLIMETERS (INCHES).
3. OUTLINE CONFORMS TO EIA-481 & EIA-541.

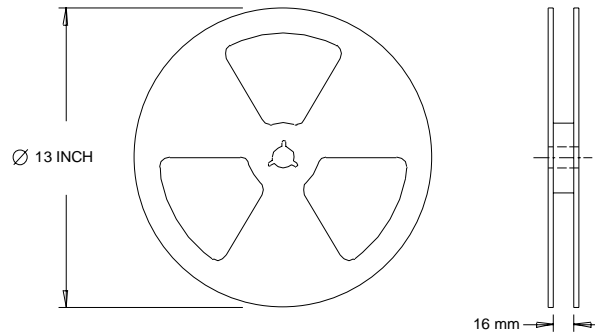

NOTES :

1. OUTLINE CONFORMS TO EIA-481.

Notes:

- ① Repetitive rating; pulse width limited by max. junction temperature.
- ② Starting $T_J = 25^\circ\text{C}$, $L = 1.0\text{mH}$
 $R_G = 25\Omega$, $I_{AS} = 30\text{A}$.
- ③ Pulse width $\leq 400\mu\text{s}$; duty cycle $\leq 2\%$.
- ④ Calculated continuous current based on maximum allowable junction temperature. Package limitation current is 30A.
- ⑤ When mounted on 1" square PCB (FR-4 or G-10 Material) .
For recommended footprint and soldering techniques refer to application note #AN-994
- ⑥ R_θ is measured at T_J approximately at 90°C

Data and specifications subject to change without notice.
This product has been designed and qualified for the industrial market.
Qualification Standards can be found on IR's Web site.

International
IR Rectifier

IR WORLD HEADQUARTERS: 233 Kansas St., El Segundo, California 90245, USA Tel: (310) 252-7105
TAC Fax: (310) 252-7903

Visit us at www.irf.com for sales contact information. 1/04

www.irf.com

Note: For the most current drawings please refer to the IR website at:
<http://www.irf.com/package/>

Mouser Electronics

Authorized Distributor

Click to View Pricing, Inventory, Delivery & Lifecycle Information:

[International Rectifier:](#)

[IRFR3711ZTRLPBF](#) [IRFU3711PBF](#)