

# MOSFET

Metal Oxide Semiconductor Field Effect Transistor

## CoolMOS™ C7

650V CoolMOS™ C7 Power Transistor  
IPZ65R019C7

## Data Sheet

Rev. 2.0  
Final

## 1 Description

CoolMOS™ is a revolutionary technology for high voltage power MOSFETs, designed according to the superjunction (SJ) principle and pioneered by Infineon Technologies.

CoolMOS™ C7 series combines the experience of the leading SJ MOSFET supplier with high class innovation. The product portfolio provides all benefits of fast switching superjunction MOSFETs offering better efficiency, reduced gate charge, easy implementation and outstanding reliability.



## Features

- Increased MOSFET dv/dt ruggedness
- Better efficiency due to best in class FOM  $R_{DS(on)} \cdot E_{oss}$  and  $R_{DS(on)} \cdot Q_g$
- Best in class  $R_{DS(on)}$  /package
- Easy to use/drive due to **driver source pin** for better control of the gate.
- Pb-free plating, halogen free mold compound
- Qualified for industrial grade applications according to JEDEC (J-STD20 and JESD22)

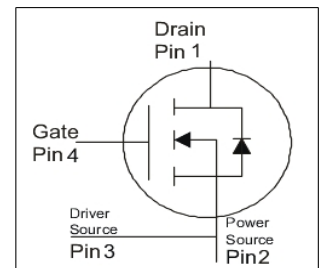

## Benefits

- Enabling higher system efficiency
- Enabling higher frequency / increased power density solutions
- System cost / size savings due to reduced cooling requirements
- Higher system reliability due to lower operating temperatures



## Applications

PFC stages and hard switching PWM stages for e.g. Computing, Server, Telecom, UPS and Solar.



*Please note: The source and sense source pins are not exchangeable. Their exchange might lead to malfunction.*

**Table 1 Key Performance Parameters**

Parameter	Value	Unit
$V_{DS} @ T_{j,max}$	700	V
$R_{DS(on),max}$	19	mΩ
$Q_{g,typ}$	215	nC
$I_{D,pulse}$	496	A
$E_{oss}@400V$	27	μJ
Body diode di/dt	70	A/μs

Type / Ordering Code	Package	Marking	Related Links
IPZ65R019C7	PG-TO 247-4	65C7019	see Appendix A

**Table of Contents**

Description .....	2
Maximum ratings .....	4
Thermal characteristics .....	5
Electrical characteristics .....	6
Electrical characteristics diagrams .....	8
Test Circuits .....	12
Package Outlines .....	13
Appendix A .....	14
Revision History .....	15
Disclaimer .....	15

## 2 Maximum ratings

at  $T_j = 25^\circ\text{C}$ , unless otherwise specified

**Table 2 Maximum ratings**

Parameter	Symbol	Values			Unit	Note / Test Condition
		Min.	Typ.	Max.		
Continuous drain current <sup>1)</sup>	$I_D$	-	-	75 62	A	$T_C=25^\circ\text{C}$ $T_C=100^\circ\text{C}$
Pulsed drain current <sup>2)</sup>	$I_{D,pulse}$	-	-	496	A	$T_C=25^\circ\text{C}$
Avalanche energy, single pulse	$E_{AS}$	-	-	583	mJ	$I_D=12.4\text{A}$ ; $V_{DD}=50\text{V}$
Avalanche energy, repetitive	$E_{AR}$	-	-	2.92	mJ	$I_D=12.4\text{A}$ ; $V_{DD}=50\text{V}$
Avalanche current, single pulse	$I_{AS}$	-	-	12.4	A	-
MOSFET dv/dt ruggedness	dv/dt	-	-	100	V/ns	$V_{DS}=0\dots400\text{V}$
Gate source voltage (static)	$V_{GS}$	-20	-	20	V	static;
Gate source voltage (dynamic)	$V_{GS}$	-30	-	30	V	AC (f>1 Hz)
Power dissipation	$P_{tot}$	-	-	446	W	$T_C=25^\circ\text{C}$
Storage temperature	$T_{stg}$	-55	-	150	$^\circ\text{C}$	-
Operating junction temperature	$T_j$	-55	-	150	$^\circ\text{C}$	-
Mounting torque	-	-	-	60	Ncm	M3 and M3.5 screws
Continuous diode forward current	$I_S$	-	-	75	A	$T_C=25^\circ\text{C}$
Diode pulse current <sup>2)</sup>	$I_{S,pulse}$	-	-	496	A	$T_C=25^\circ\text{C}$
Reverse diode dv/dt <sup>3)</sup>	dv/dt	-	-	1.5	V/ns	$V_{DS}=0\dots400\text{V}$ , $I_{SD}\leq I_S$ , $T_j=25^\circ\text{C}$
Maximum diode commutation speed	di/dt	-	-	70	A/ $\mu\text{s}$	$V_{DS}=0\dots400\text{V}$ , $I_{SD}\leq I_S$ , $T_j=25^\circ\text{C}$
Insulation withstand voltage	$V_{ISO}$	-	-	n.a.	V	$V_{rms}$ , $T_C=25^\circ\text{C}$ , $t=1\text{min}$

<sup>1)</sup> Limited by  $T_{j,max}$ .

<sup>2)</sup> Pulse width  $t_p$  limited by  $T_{j,max}$

<sup>3)</sup> Identical low side and high side switch with identical  $R_G$

### 3 Thermal characteristics

**Table 3 Thermal characteristics**

Parameter	Symbol	Values			Unit	Note / Test Condition
		Min.	Typ.	Max.		
Thermal resistance, junction - case	$R_{thJC}$	-	-	0.28	°C/W	-
Thermal resistance, junction - ambient	$R_{thJA}$	-	-	62	°C/W	leaded
Thermal resistance, junction - ambient for SMD version	$R_{thJA}$	-	-	-	°C/W	n.a.
Soldering temperature, wavesoldering only allowed at leads	$T_{sold}$	-	-	260	°C	1.6mm (0.063 in.) from case for 10s

## 4 Electrical characteristics

at  $T_j=25^\circ\text{C}$ , unless otherwise specified

**Table 4 Static characteristics**

Parameter	Symbol	Values			Unit	Note / Test Condition
		Min.	Typ.	Max.		
Drain-source breakdown voltage	$V_{(BR)DSS}$	650	-	-	V	$V_{GS}=0V, I_D=1mA$
Gate threshold voltage	$V_{(GS)th}$	3	3.5	4	V	$V_{DS}=V_{GS}, I_D=2.92mA$
Zero gate voltage drain current	$I_{DSS}$	-	-	5	$\mu\text{A}$	$V_{DS}=650, V_{GS}=0V, T_j=25^\circ\text{C}$ $V_{DS}=650, V_{GS}=0V, T_j=150^\circ\text{C}$
Gate-source leakage current	$I_{GSS}$	-	-	100	nA	$V_{GS}=20V, V_{DS}=0V$
Drain-source on-state resistance	$R_{DS(on)}$	-	0.017 0.040	0.019 -	$\Omega$	$V_{GS}=10V, I_D=58.3A, T_j=25^\circ\text{C}$ $V_{GS}=10V, I_D=58.3A, T_j=150^\circ\text{C}$
Gate resistance	$R_G$	-	0.45	-	$\Omega$	$f=1\text{MHz}$ , open drain

**Table 5 Dynamic characteristics**

Parameter	Symbol	Values			Unit	Note / Test Condition
		Min.	Typ.	Max.		
Input capacitance	$C_{iss}$	-	9900	-	pF	$V_{GS}=0V, V_{DS}=400V, f=250\text{kHz}$
Output capacitance	$C_{oss}$	-	160	-	pF	$V_{GS}=0V, V_{DS}=400V, f=250\text{kHz}$
Effective output capacitance, energy related <sup>1)</sup>	$C_{o(er)}$	-	338	-	pF	$V_{GS}=0V, V_{DS}=0\dots400V$
Effective output capacitance, time related <sup>2)</sup>	$C_{o(tr)}$	-	3320	-	pF	$I_D=\text{constant}, V_{GS}=0V, V_{DS}=0\dots400V$
Turn-on delay time	$t_{d(on)}$	-	30	-	ns	$V_{DD}=400V, V_{GS}=13V, I_D=58.3A, R_G=1.8\Omega$
Rise time	$t_r$	-	27	-	ns	$V_{DD}=400V, V_{GS}=13V, I_D=58.3A, R_G=1.8\Omega$
Turn-off delay time	$t_{d(off)}$	-	106	-	ns	$V_{DD}=400V, V_{GS}=13V, I_D=58.3A, R_G=1.8\Omega$
Fall time	$t_f$	-	5	-	ns	$V_{DD}=400V, V_{GS}=13V, I_D=58.3A, R_G=1.8\Omega$

**Table 6 Gate charge characteristics**

Parameter	Symbol	Values			Unit	Note / Test Condition
		Min.	Typ.	Max.		
Gate to source charge	$Q_{gs}$	-	53	-	nC	$V_{DD}=400V, I_D=58.3A, V_{GS}=0$ to 10V
Gate to drain charge	$Q_{gd}$	-	71	-	nC	$V_{DD}=400V, I_D=58.3A, V_{GS}=0$ to 10V
Gate charge total	$Q_g$	-	215	-	nC	$V_{DD}=400V, I_D=58.3A, V_{GS}=0$ to 10V
Gate plateau voltage	$V_{plateau}$	-	5.4	-	V	$V_{DD}=400V, I_D=58.3A, V_{GS}=0$ to 10V

<sup>1)</sup>  $C_{o(er)}$  is a fixed capacitance that gives the same stored energy as  $C_{oss}$  while  $V_{DS}$  is rising from 0 to 400V

<sup>2)</sup>  $C_{o(tr)}$  is a fixed capacitance that gives the same charging time as  $C_{oss}$  while  $V_{DS}$  is rising from 0 to 400V

**Table 7 Reverse diode characteristics**

Parameter	Symbol	Values			Unit	Note / Test Condition
		Min.	Typ.	Max.		
Diode forward voltage	$V_{SD}$	-	0.9	-	V	$V_{GS}=0V, I_F=58.3A, T_j=25^\circ C$
Reverse recovery time	$t_{rr}$	-	760	-	ns	$V_R=400V, I_F=75A, di_F/dt=70A/\mu s$
Reverse recovery charge	$Q_{rr}$	-	20	-	$\mu C$	$V_R=400V, I_F=75A, di_F/dt=70A/\mu s$
Peak reverse recovery current	$I_{rrm}$	-	50	-	A	$V_R=400V, I_F=75A, di_F/dt=70A/\mu s$

## 5 Electrical characteristics diagrams

Table 8

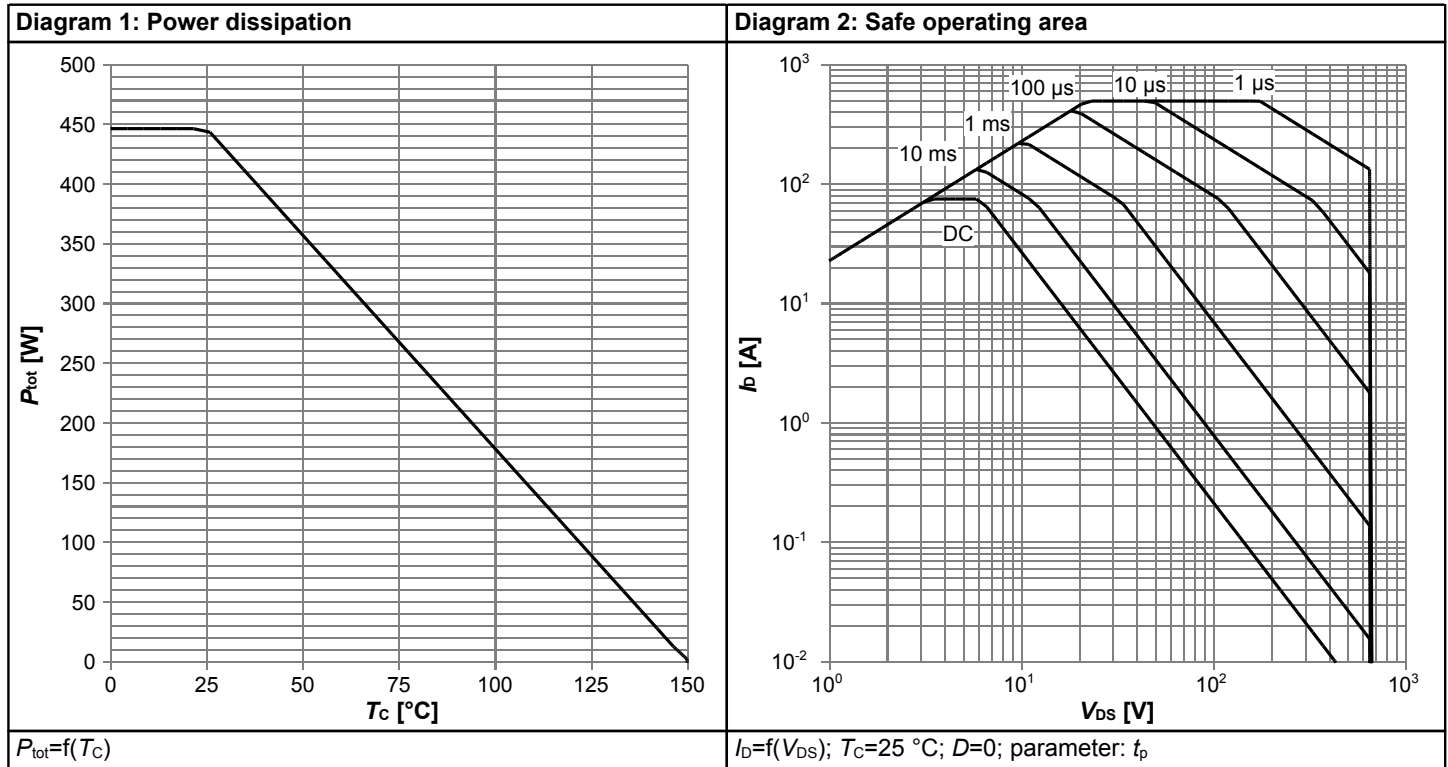

Table 9

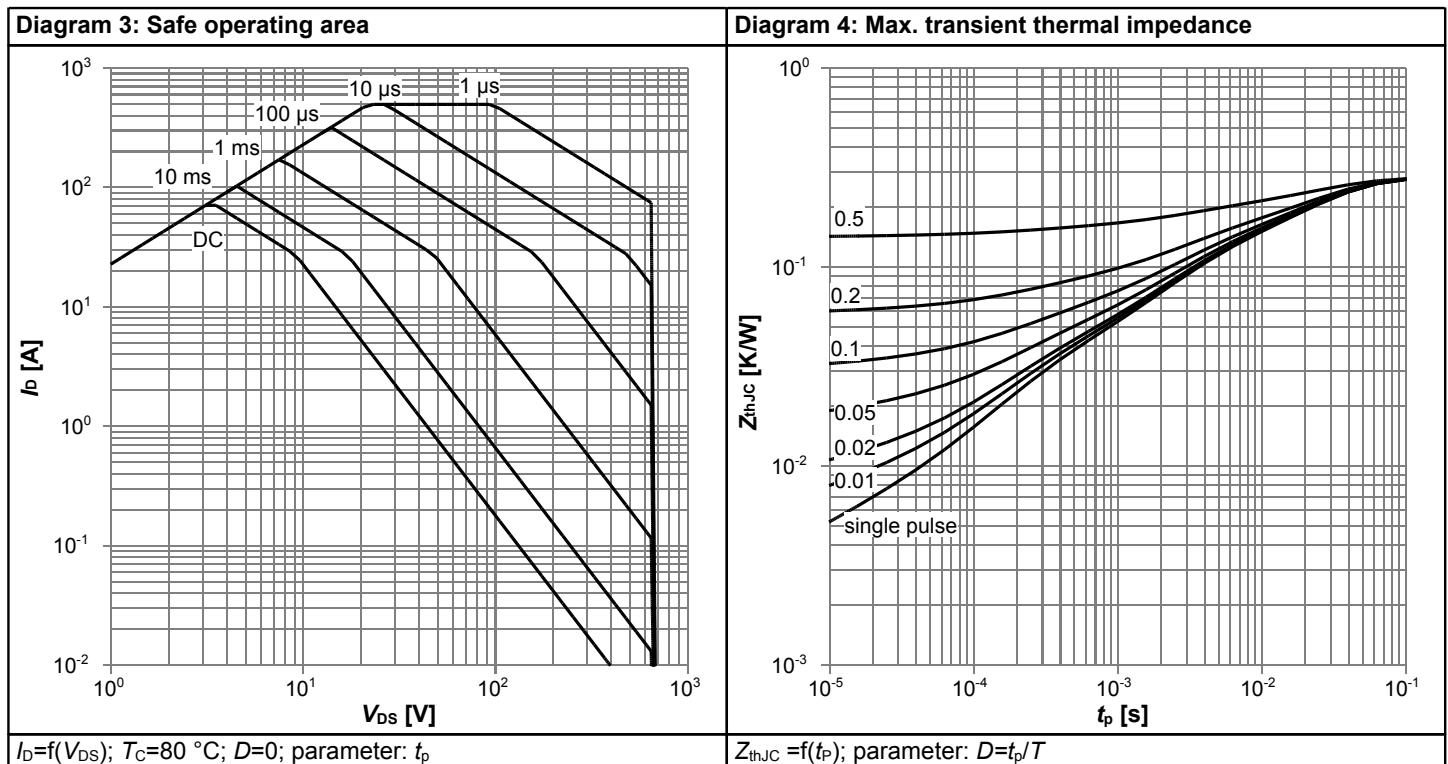



Table 10

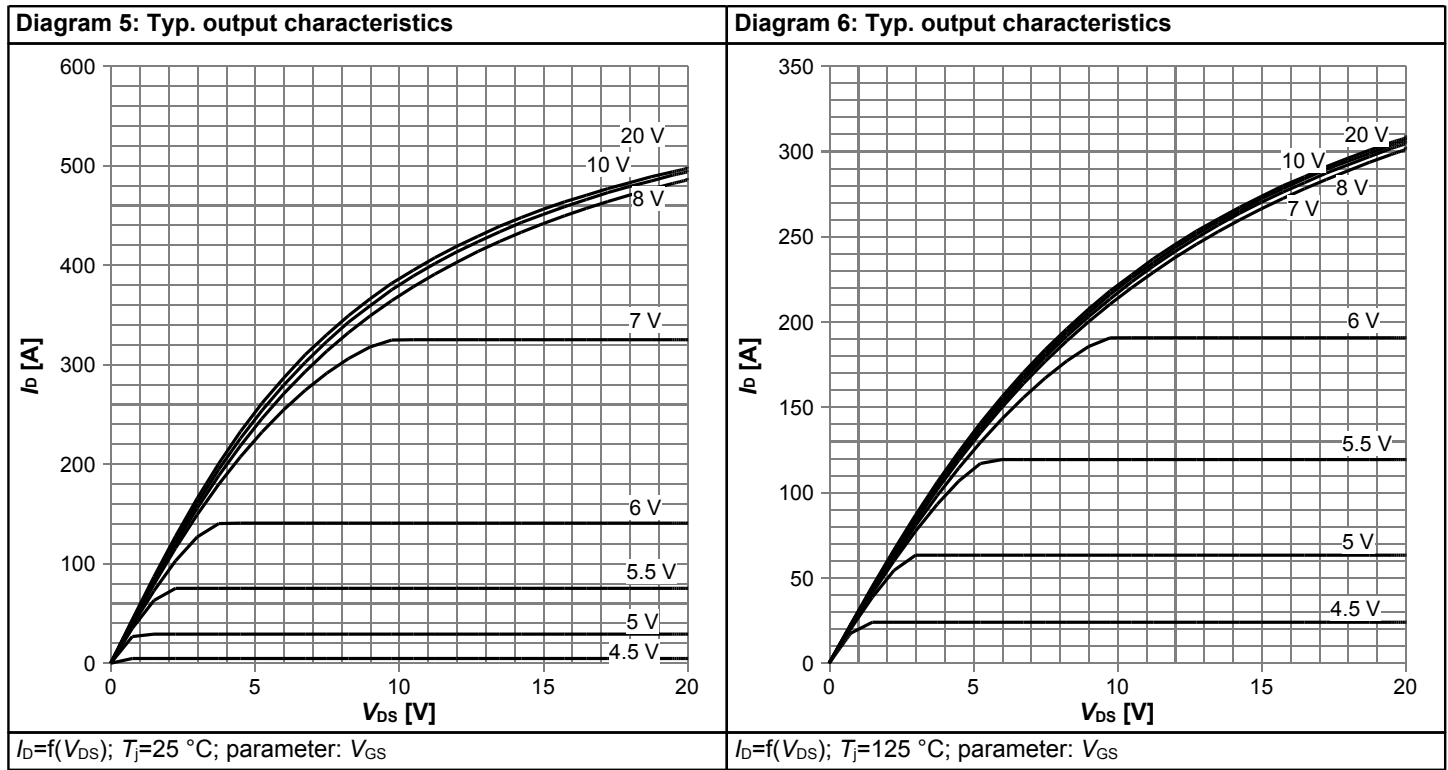

Table 11

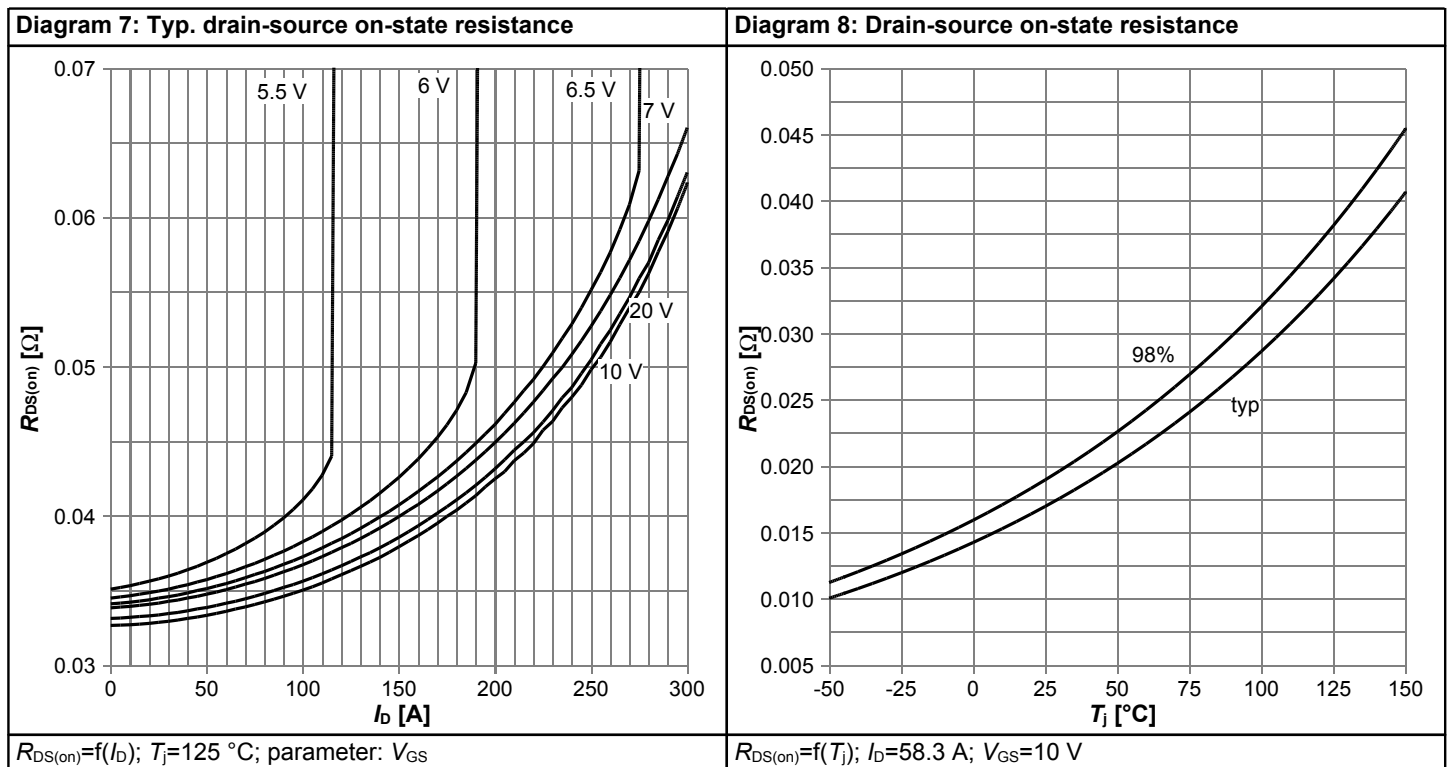

Table 12

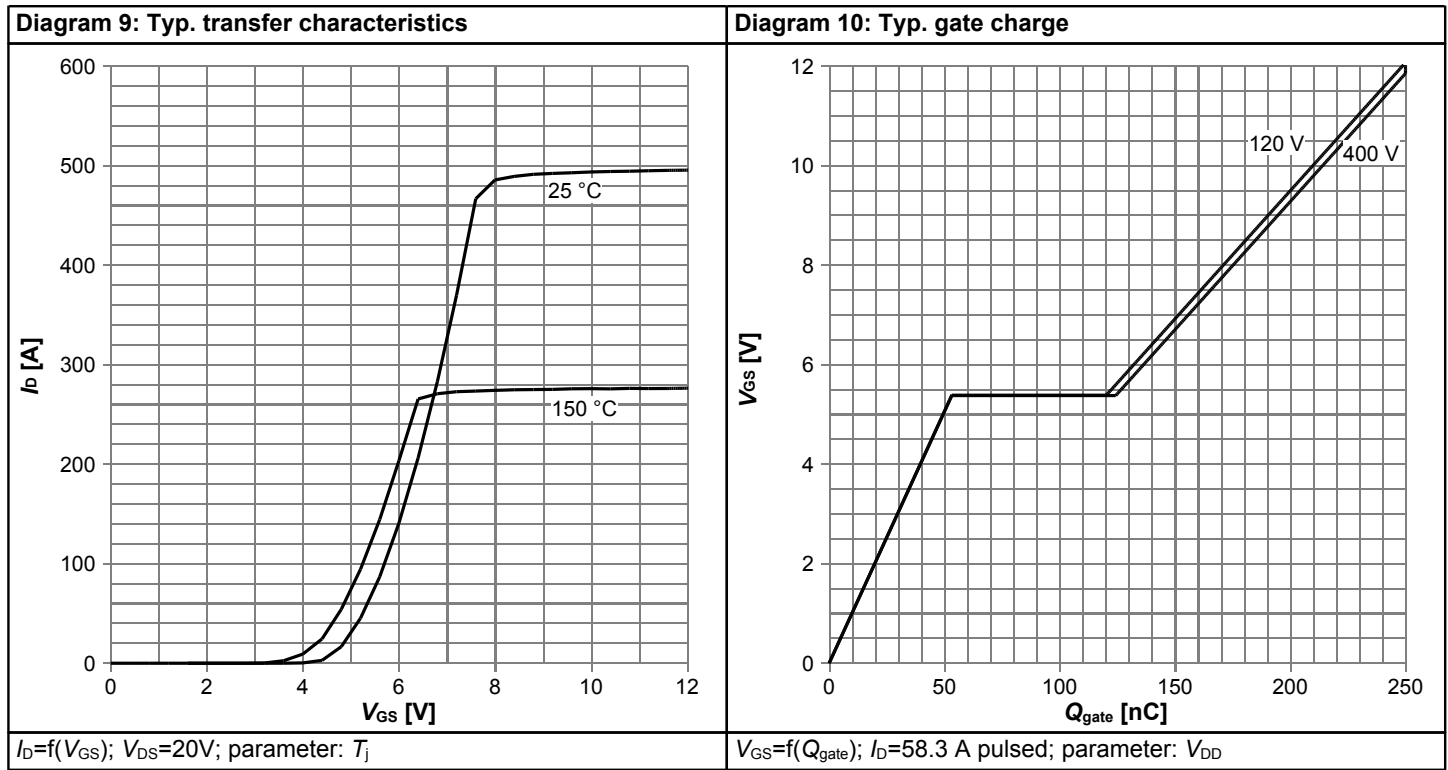

Table 13

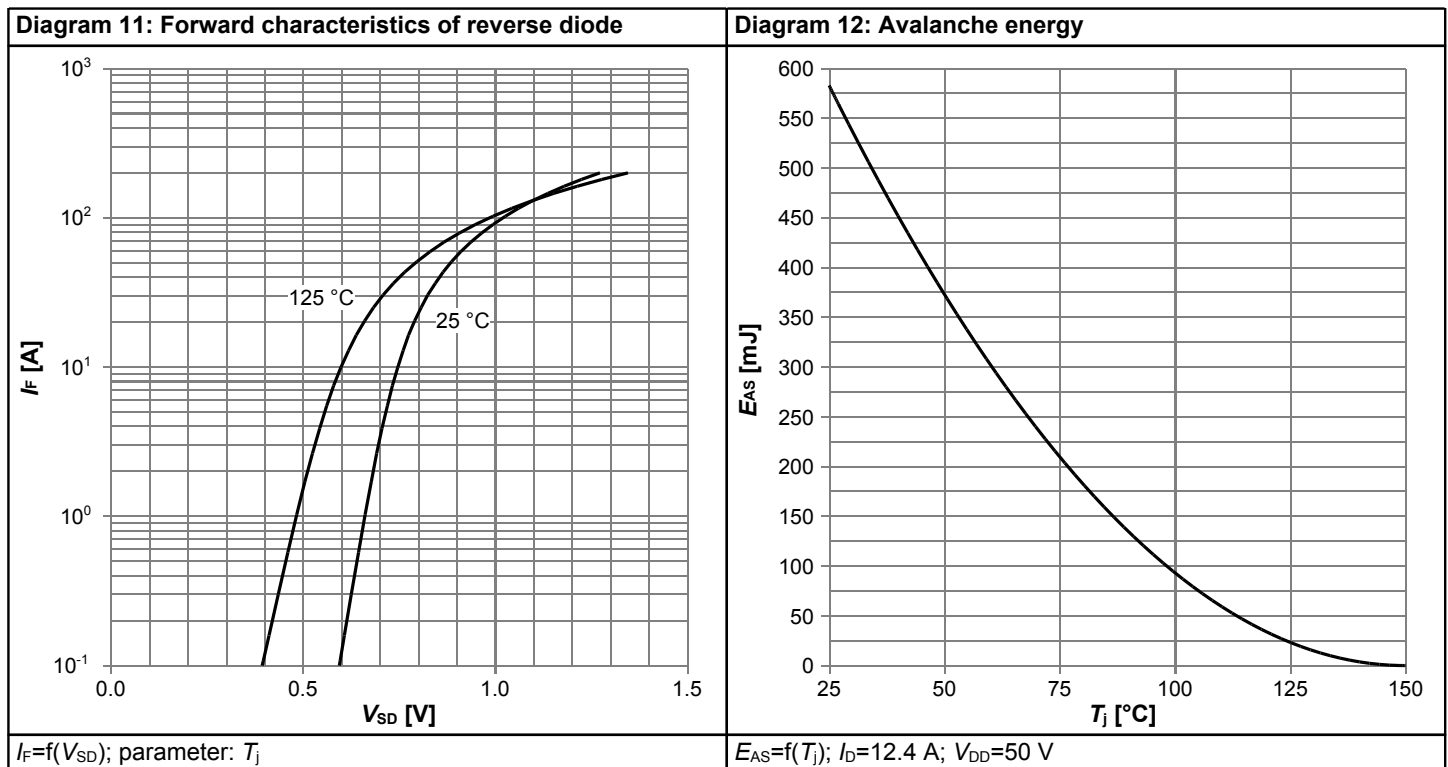

Table 14

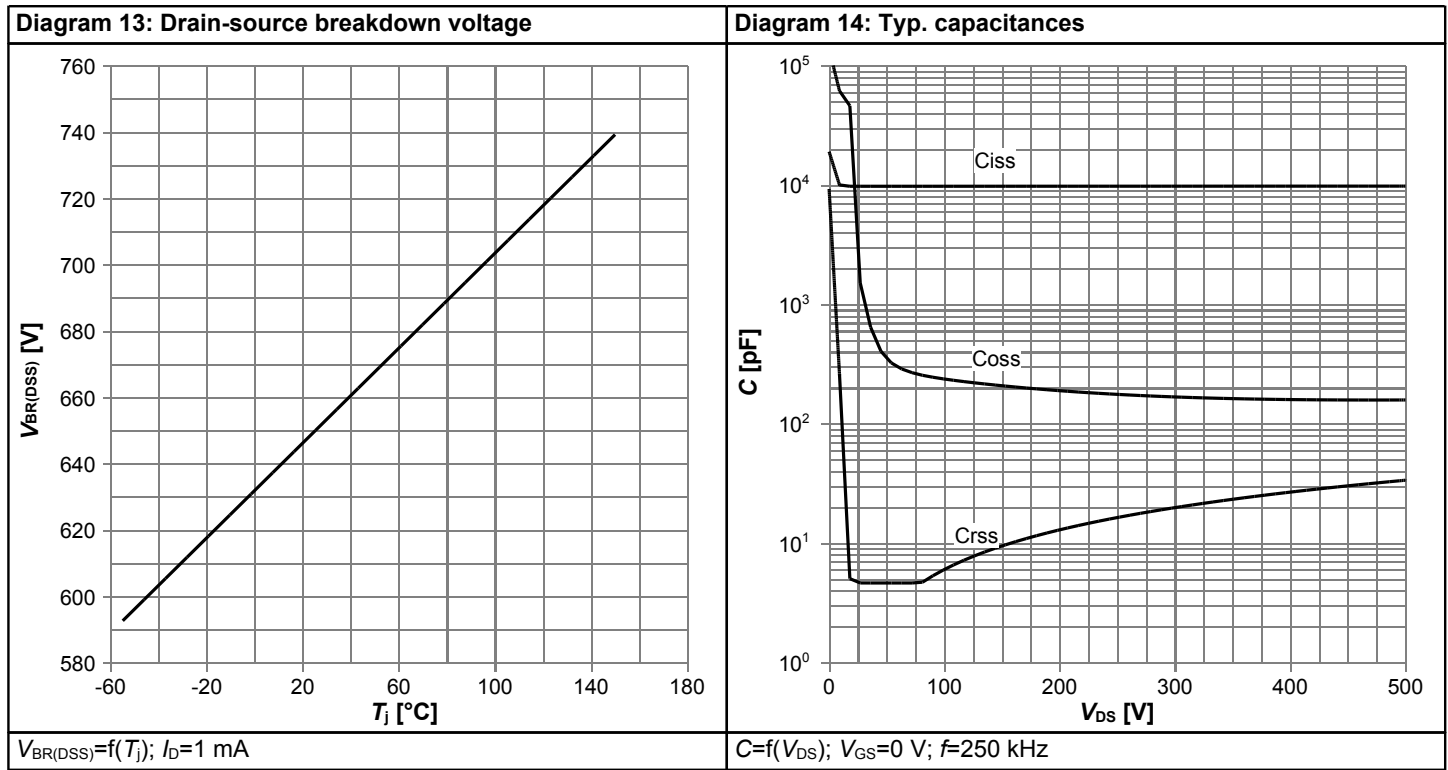
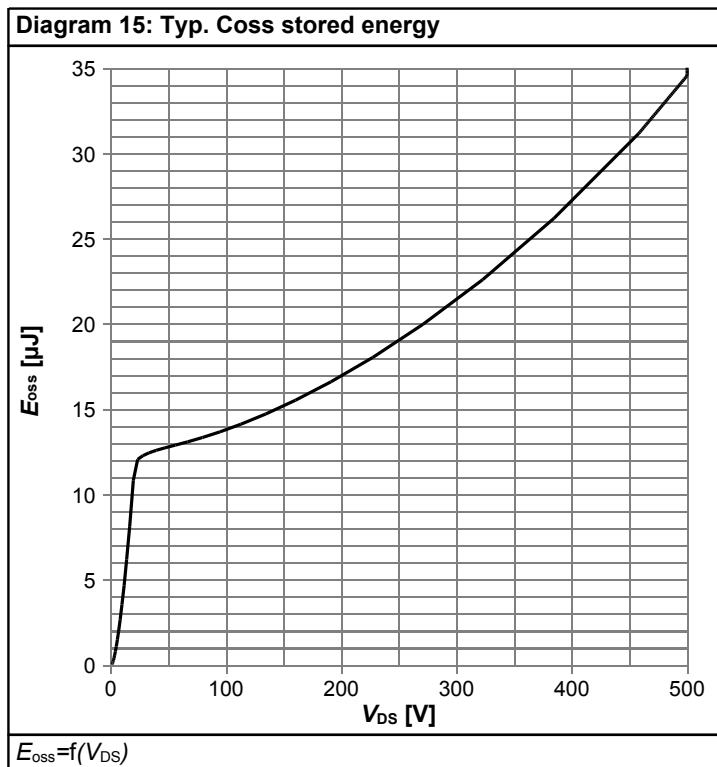
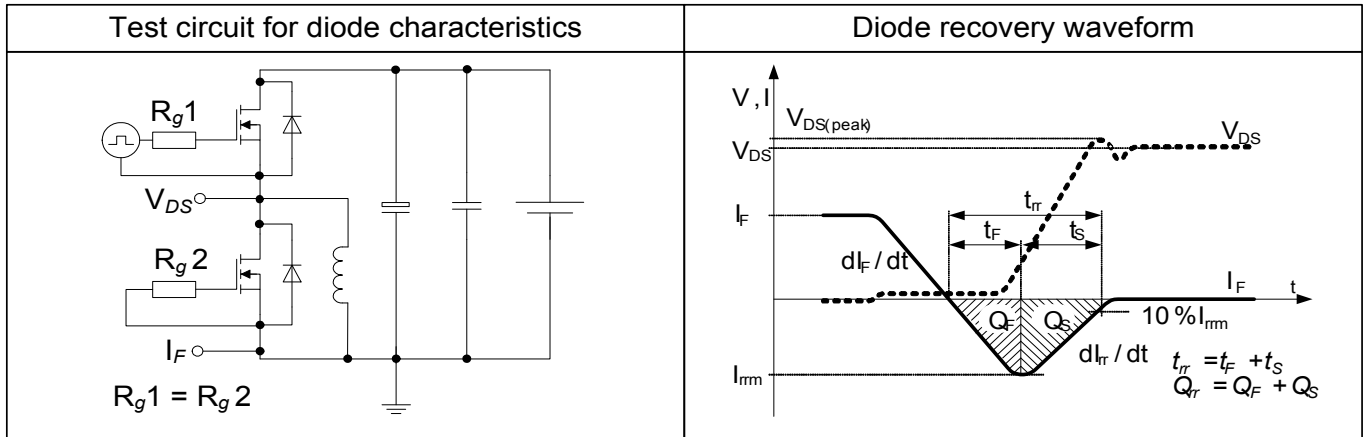

Table 15



## 6 Test Circuits

**Table 16 Diode characteristics**



**Table 17 switching times (ss)**

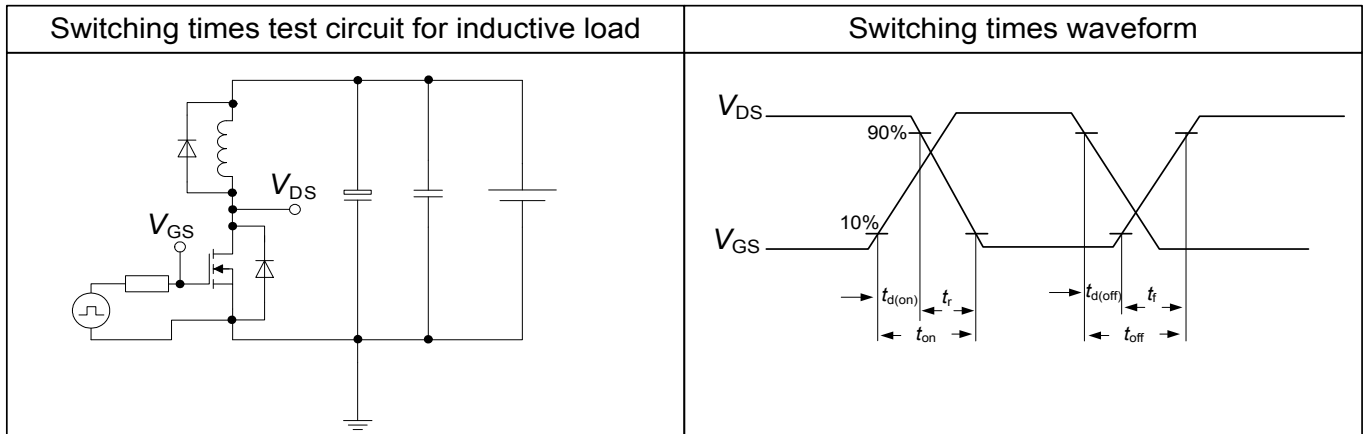

**Table 18 Unclamped inductive load (ss)**

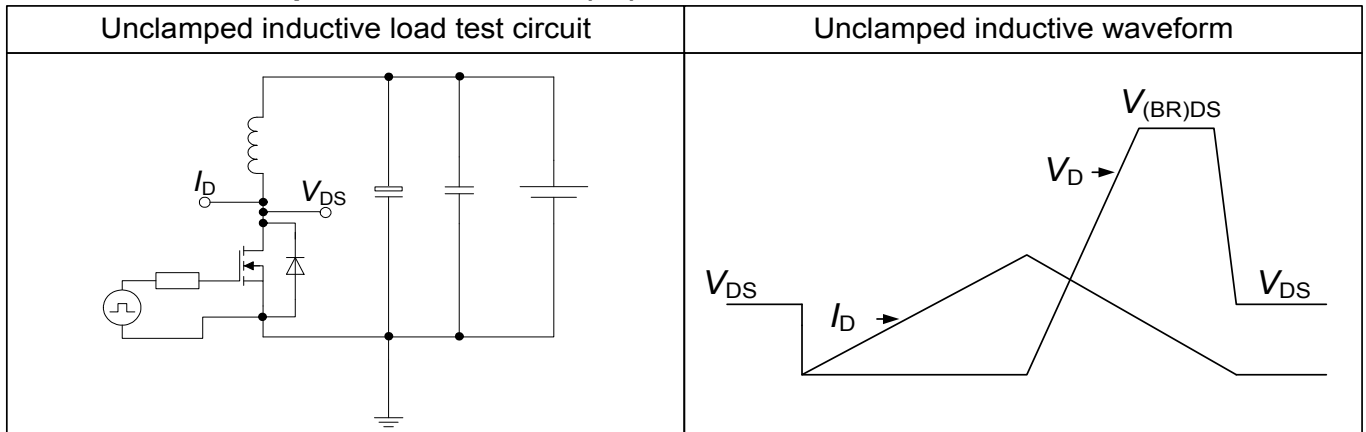

## 7 Package Outlines

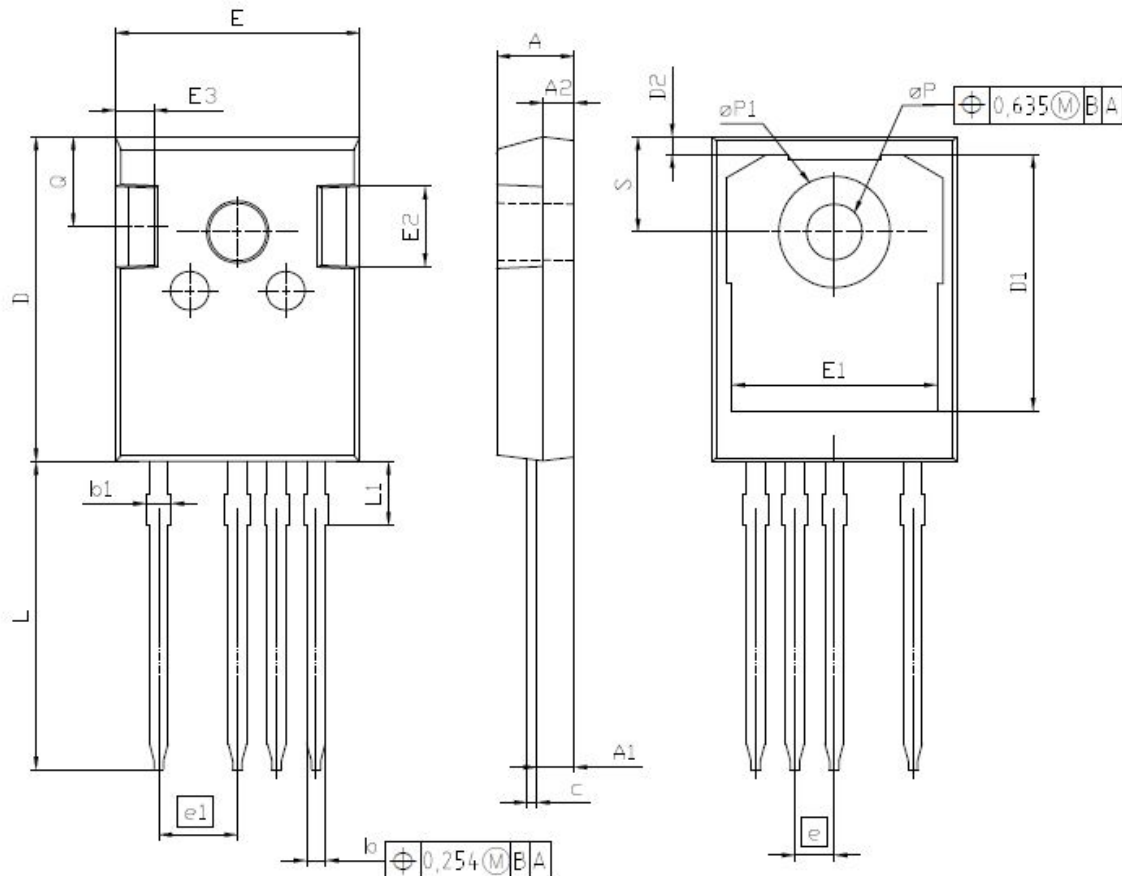

DIM	MILLIMETERS		INCHES	
	MIN	MAX	MIN	MAX
A	4.83	5.21	0.190	0.205
A1	2.29	2.54	0.090	0.100
A2	1.90	2.16	0.075	0.085
b	1.07	1.33	0.042	0.052
b1	1.10	1.70	0.043	0.067
c	0.50	0.70	0.020	0.028
D	20.80	21.10	0.819	0.831
D1	16.25	17.65	0.640	0.695
D2	0.95	1.35	0.037	0.053
E	15.70	16.13	0.618	0.635
E1	13.10	14.15	0.516	0.557
E2	3.68	5.10	0.145	0.201
E3	1.00	2.60	0.039	0.102
e	2.54 (BSC)		0.100 (BSC)	
e1	5.08		0.200	
N	4		4	
L	19.72	20.32	0.776	0.800
L1	4.02	4.40	0.158	0.173
øP	3.50	3.70	0.138	0.146
øP1	7.00	7.40	0.276	0.291
Q	5.49	6.00	0.216	0.236
S	6.04	6.30	0.238	0.248

DOCUMENT NO.  
Z8B00168124

SCALE

7.5mm

EUROPEAN PROJECTION

ISSUE DATE  
29-01-2013

REVISION  
1

Figure 1 Outline PG-TO 247-4, dimensions in mm/inches

## 8 Appendix A

### Table 19 Related Links

- IFX CoolMOS™ C7 Webpage: [www.infineon.com](http://www.infineon.com)
- IFX CoolMOS™ C7 application note: [www.infineon.com](http://www.infineon.com)
- IFX CoolMOS™ C7 simulation model: [www.infineon.com](http://www.infineon.com)
- IFX Design tools: [www.infineon.com](http://www.infineon.com)

## Revision History

IPZ65R019C7

**Revision: 2013-04-30, Rev. 2.0**

Previous Revision

Revision	Date	Subjects (major changes since last revision)
2.0	2013-04-30	Release of final version

### We Listen to Your Comments

Any information within this document that you feel is wrong, unclear or missing at all? Your feedback will help us to continuously improve the quality of this document. Please send your proposal (including a reference to this document) to:

[erratum@infineon.com](mailto:erratum@infineon.com)

### Edition 2011-08-01

#### Published by

**Infineon Technologies AG**

**81726 München, Germany**

**© 2011 Infineon Technologies AG**

**All Rights Reserved.**

### Legal Disclaimer

The information given in this document shall in no event be regarded as a guarantee of conditions or characteristics. With respect to any examples or hints given herein, any typical values stated herein and/or any information regarding the application of the device, Infineon Technologies hereby disclaims any and all warranties and liabilities of any kind, including without limitation, warranties of non-infringement of intellectual property rights of any third party.

### Information

For further information on technology, delivery terms and conditions and prices please contact your nearest Infineon Technologies Office ([www.infineon.com](http://www.infineon.com)).

### Warnings

Due to technical requirements, components may contain dangerous substances. For information on the types in question, please contact the nearest Infineon Technologies Office.

The Infineon Technologies component described in this Data Sheet may be used in life-support devices or systems and/or automotive, aviation and aerospace applications or systems only with the express written approval of Infineon Technologies, if a failure of such components can reasonably be expected to cause the failure of that life-support, automotive, aviation and aerospace device or system or to affect the safety or effectiveness of that device or system. Life support devices or systems are intended to be implanted in the human body or to support and/or maintain and sustain and/or protect human life. If they fail, it is reasonable to assume that the health of the user or other persons may be endangered.

# Mouser Electronics

Authorized Distributor

Click to View Pricing, Inventory, Delivery & Lifecycle Information:

[Infineon:](#)

[IPZ65R019C7XKSA1](#)