

TVS Diode

Transient Voltage Suppressor Diodes

ESD203-B1-02 Series

Bi-directional ESD / Transient / Surge Protection Diodes

ESD203-B1-02ELS
ESD203-B1-02EL

Data Sheet

Revision 1.3, 2013-12-19
Final

Revision History: Rev. 1.2,, 2013-11-26

Page or Item	Subjects (major changes since previous revision)
Revision 1.3, 2013-12-19	
5	Update of Table 2-2)

Trademarks of Infineon Technologies AG

AURIX™, BlueMoon™, C166™, CanPAK™, CIPOS™, CIPURSE™, COMNEON™, EconoPACK™, CoolMOS™, CoolSET™, CORECONTROL™, CROSSAVE™, DAVE™, EasyPIM™, EconoBRIDGE™, EconoDUAL™, EconoPIM™, EiceDRIVER™, eupec™, FCOS™, HITFET™, HybridPACK™, I²RF™, ISOFACE™, IsoPACK™, MIPAQ™, ModSTACK™, my-d™, NovalithIC™, OmniTune™, OptiMOS™, ORIGA™, PRIMARION™, PrimePACK™, PrimeSTACK™, PRO-SIL™, PROFET™, RASIC™, ReverSave™, SatRIC™, SIEGET™, SINDRION™, SIPMOS™, SMARTi™, SmartLEWIS™, SOLID FLASH™, TEMPFET™, thinQ!™, TRENCHSTOP™, TriCore™, X-GOLD™, X-PMU™, XMM™, XPOSYS™.

Other Trademarks

Advance Design System™ (ADS) of Agilent Technologies, AMBA™, ARM™, MULTI-ICE™, KEIL™, PRIMECELL™, REALVIEW™, THUMB™, μVision™ of ARM Limited, UK. AUTOSAR™ is licensed by AUTOSAR development partnership. Bluetooth™ of Bluetooth SIG Inc. CAT-ig™ of DECT Forum. COLOSSUS™, FirstGPS™ of Trimble Navigation Ltd. EMV™ of EMVCo, LLC (Visa Holdings Inc.). EPCOS™ of Epcos AG. FLEXGO™ of Microsoft Corporation. FlexRay™ is licensed by FlexRay Consortium. HYPERTERMINAL™ of Hilgraeve Incorporated. IEC™ of Commission Electrotechnique Internationale. IrDA™ of Infrared Data Association Corporation. ISO™ of INTERNATIONAL ORGANIZATION FOR STANDARDIZATION. MATLAB™ of MathWorks, Inc. MAXIM™ of Maxim Integrated Products, Inc. MICROTEC™, NUCLEUS™ of Mentor Graphics Corporation. Mifare™ of NXP. MIPI™ of MIPI Alliance, Inc. MIPS™ of MIPS Technologies, Inc., USA. muRata™ of MURATA MANUFACTURING CO., MICROWAVE OFFICE™ (MWO) of Applied Wave Research Inc., OmniVision™ of OmniVision Technologies, Inc. Openwave™ Openwave Systems Inc. RED HAT™ Red Hat, Inc. RFMD™ RF Micro Devices, Inc. SIRIUS™ of Sirius Satellite Radio Inc. SOLARIS™ of Sun Microsystems, Inc. SPANSION™ of Spansion LLC Ltd. Symbian™ of Symbian Software Limited. TAIYO YUDEN™ of Taiyo Yuden Co. TEAKLITE™ of CEVA, Inc. TEKTRONIX™ of Tektronix Inc. TOKO™ of TOKO KABUSHIKI KAISHA TA. UNIX™ of X/Open Company Limited. VERILOG™, PALLADIUM™ of Cadence Design Systems, Inc. VLYNQ™ of Texas Instruments Incorporated. VXWORKS™, WIND RIVER™ of WIND RIVER SYSTEMS, INC. ZETEX™ of Diodes Zetex Limited.

Last Trademarks Update 2010-10-26

1 Bi-directional ESD / Transient / Surge Protection Diodes

1.1 Features

- ESD/Transient/Surge protection of one data / V_{bus} line exceeding standard:
 - IEC61000-4-2 (ESD): ± 30 kV (air/contact discharge)
 - IEC61000-4-4 (EFT): ± 50 A (5/50 ns)
 - IEC61000-4-5 (surge): ± 5 A (8/20 μ s)
- Bi-directional symmetrical working voltage: $V_{RWM} = \pm 13.2$ V
- Low capacitance: $C_L = 6$ pF (typ.)
- Very low ESD clamping voltage, very low dynamic resistance: $R_{DYN} = 0.29$ Ω (typ.)
- Pb-free (RoHS compliant) and halogen free package



1.2 Application Examples

- ESD protection of keypad, touchpad, buttons, audio lines, ect.

1.3 Product Description

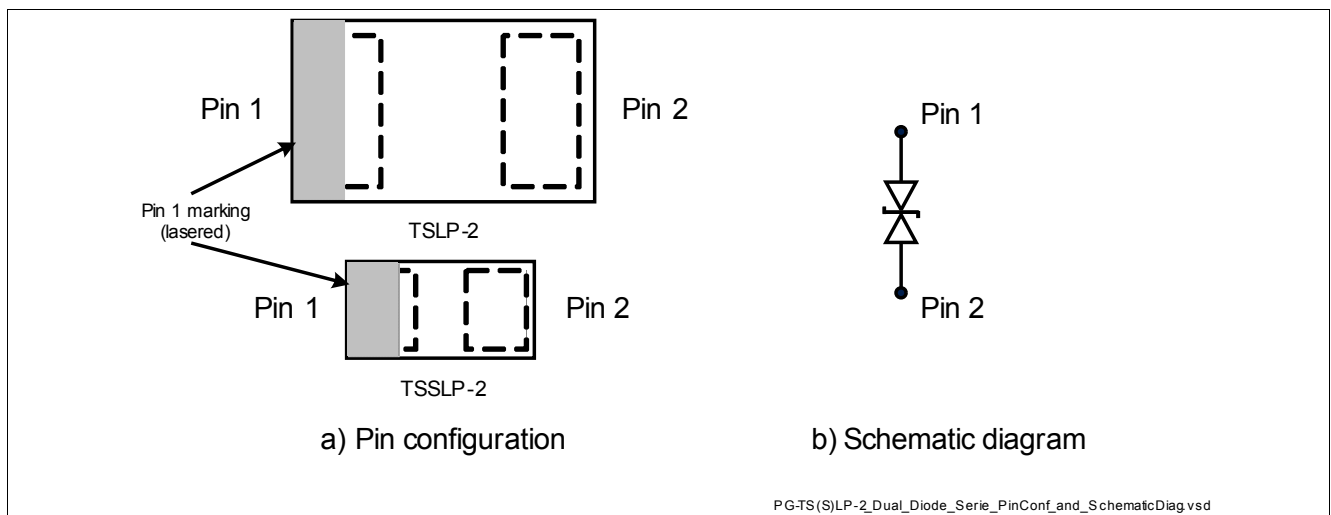

Figure 1-1 Pin Configuration and Schematic Diagram

Table 1-1 Ordering Information

Type	Package	Configuration	Marking code
ESD203-B1-02ELS	TSSLP-2-4	1 line, bi-directional	<u>H</u>
ESD203-B1-02EL	TSLP-2-20	1 line, bi-directional	H

2 Characteristics

2.1 Maximum Ratings

Table 2-1 Maximum Ratings at $T_A = 25\text{ }^\circ\text{C}$, unless otherwise specified¹⁾

Parameter	Symbol	Values			Unit
		Min.	Typ.	Max.	
ESD ²⁾ air / contact discharge	V_{ESD}	-	-	30	kV
Peak pulse current ($t_p = 8/20\text{ }\mu\text{s}$) ³⁾	I_{PP}	-	-	5	A
Peak pulse power ($t_p = 8/20\text{ }\mu\text{s}$) ³⁾	P_{PK}	-	-	115	W
Operating temperature range	T_{OP}	-55	-	125	$^\circ\text{C}$
Storage temperature	T_{stg}	-65	-	150	$^\circ\text{C}$

- 1) Device is electrically symmetrical
- 2) V_{ESD} according to IEC61000-4-2
- 3) I_{PP} according to IEC61000-4-5

Attention: Stresses above the max. values listed here may cause permanent damage to the device. Exposure to absolute maximum rating conditions for extended periods may affect device reliability. Maximum ratings are absolute ratings; exceeding only one of these values may cause irreversible damage to the integrated circuit.

2.2 Electrical Characteristics at $T_A = 25\text{ }^\circ\text{C}$, unless otherwise specified

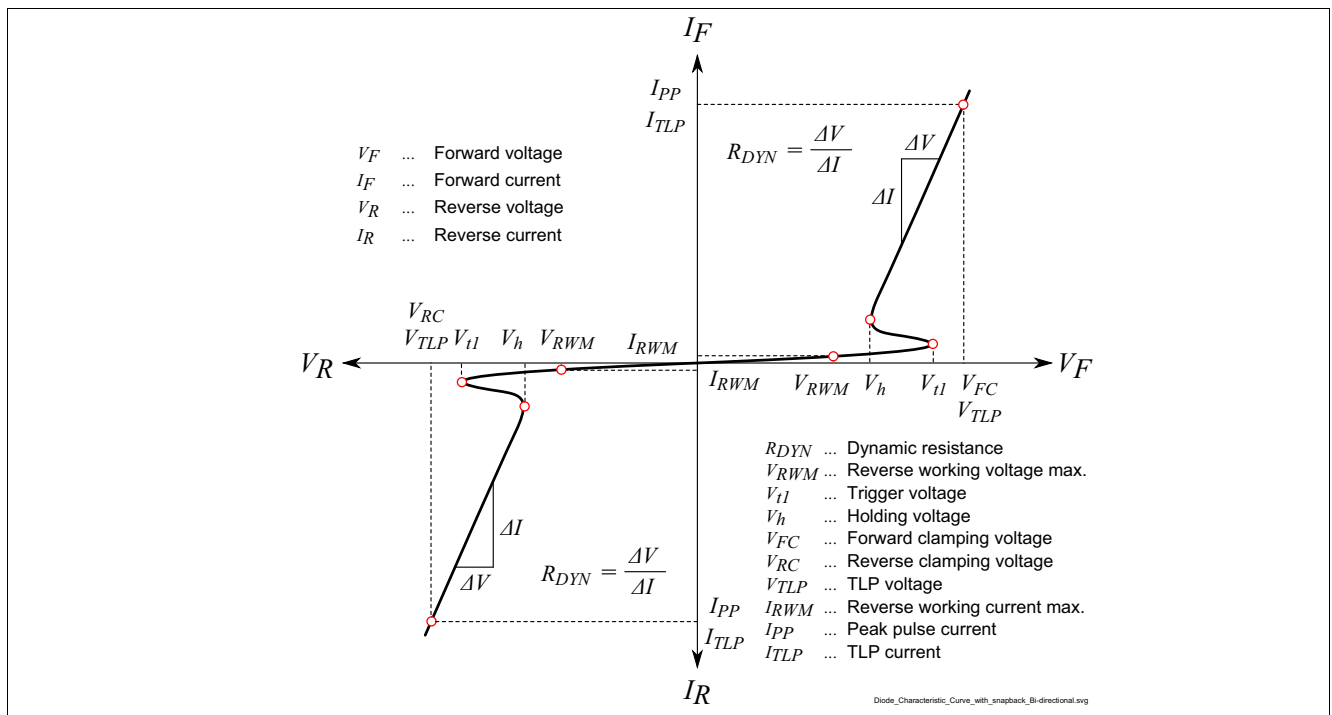

Figure 2-1 Definitions of electrical characteristics

Table 2-2 DC Characteristics at $T_A = 25\text{ }^\circ\text{C}$, unless otherwise specified¹⁾

Parameter	Symbol	Values			Unit	Note / Test Condition
		Min.	Typ.	Max.		
Reverse working voltage	V_{RWM}	-	-	13.2	V	
Reverse current	I_R	-	1	50	nA	$V_R = 12\text{ V}$
Trigger voltage	V_{t1}	13.7	-	-	V	
Holding voltage	V_h	13.7	16	-	V	$I_R = 10\text{ mA}$

1) Device is electrically symmetrical

Table 2-3 AC Characteristics at $T_A = 25\text{ }^\circ\text{C}$, unless otherwise specified

Parameter	Symbol	Values			Unit	Note / Test Condition
		Min.	Typ.	Max.		
Line capacitance	C_L	-	6	9	pF	$V_R = 0\text{ V}, f = 1\text{ MHz}$

Table 2-4 ESD and Surge Characteristics at $T_A = 25\text{ }^\circ\text{C}$, unless otherwise specified

Parameter	Symbol	Values			Unit	Note / Test Condition
		Min.	Typ.	Max.		
Clamping voltage ¹⁾	V_{CL}	-	17	-	V	$I_{TLP} = 16\text{ A}$
		-	23	-		$I_{TLP} = 30\text{ A}$
Clamping voltage ²⁾		-	17	-		$I_{PP} = 1\text{ A}$
		-	20	23		$I_{PP} = 5\text{ A}$
Dynamic resistance ¹⁾	R_{DYN}	-	0.29	-	Ω	

 1) ANSI/ESD STM5.5.1 - Electrostatic Discharge Sensitive Testing using Transmission Line Pulse (TLP) Model. TLP conditions: $Z_0 = 50\ \Omega$, $t_p = 100\text{ ns}$, $t_r = 0.6\text{ ns}$, I_{TLP} and V_{TLP} averaging window: $t_1 = 30\text{ ns}$ to $t_2 = 60\text{ ns}$, extraction of dynamic resistance using least squares fit of TLP characteristic between $I_{TLP1} = 5\text{ A}$ and $I_{TLP2} = 40\text{ A}$. Please refer to Application Note AN210[1]

 2) I_{PP} according to IEC61000-4-5 ($t_p = 8/20\ \mu\text{s}$)

Typical Characteristics at $T_A = 25\text{ }^\circ\text{C}$, unless otherwise specified

3 Typical Characteristics at $T_A = 25\text{ }^\circ\text{C}$, unless otherwise specified

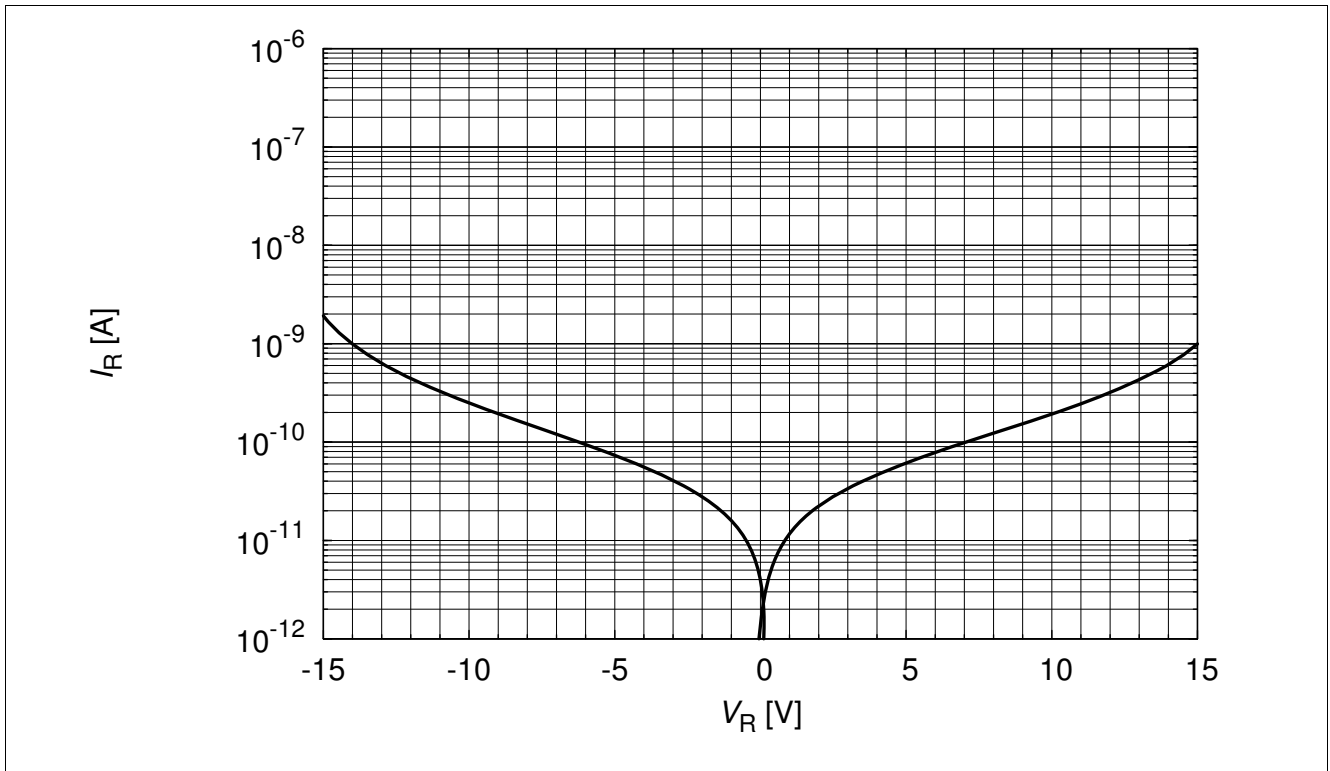

Figure 3-1 Reverse current: $I_R = f(V_R)$

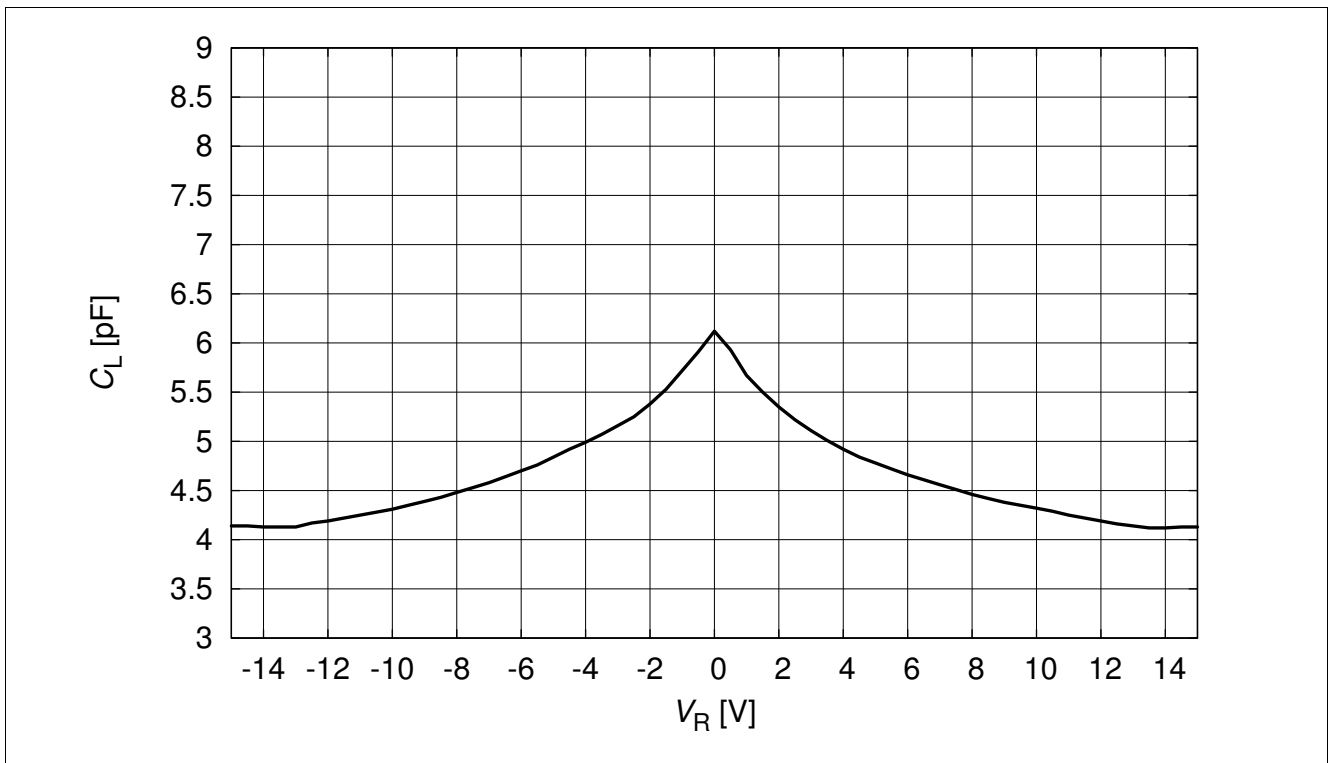

Figure 3-2 Line capacitance: $C_L = f(V_R), f = 1\text{ MHz}$

Typical Characteristics at $T_A = 25\text{ }^\circ\text{C}$, unless otherwise specified

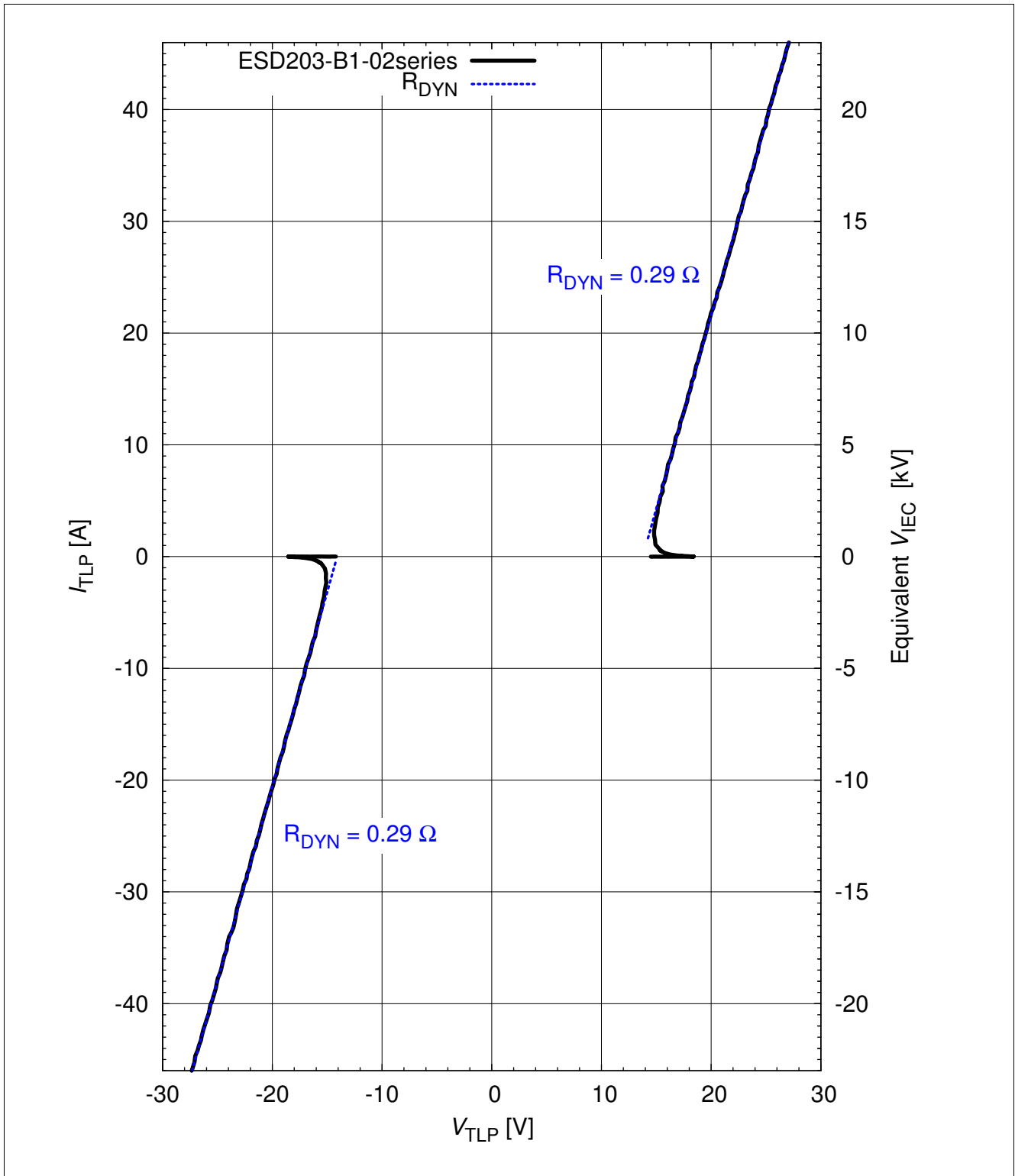

Figure 3-3 Clamping voltage (TLP): $I_{TLP} = f(V_{TLP})$ according ANSI/ESD STM5.5.1 - Electrostatic Discharge Sensitivity Testing using Transmission Line Pulse (TLP) Model. TLP conditions: $Z_0 = 50\ \Omega$, $t_p = 100\text{ ns}$, $t_r = 0.6\text{ ns}$, I_{TLP} and V_{TLP} averaging window: $t_1 = \text{ns}$ to $t_2 = 60\text{ ns}$, extraction of dynamic resistance using squares fit to TLP characteristics between $I_{TLP1} = 5\text{ A}$ and $I_{TLP2} = 40\text{ A}$. Please refer to Application Note AN210 [1]

Typical Characteristics at $T_A = 25\text{ }^\circ\text{C}$, unless otherwise specified

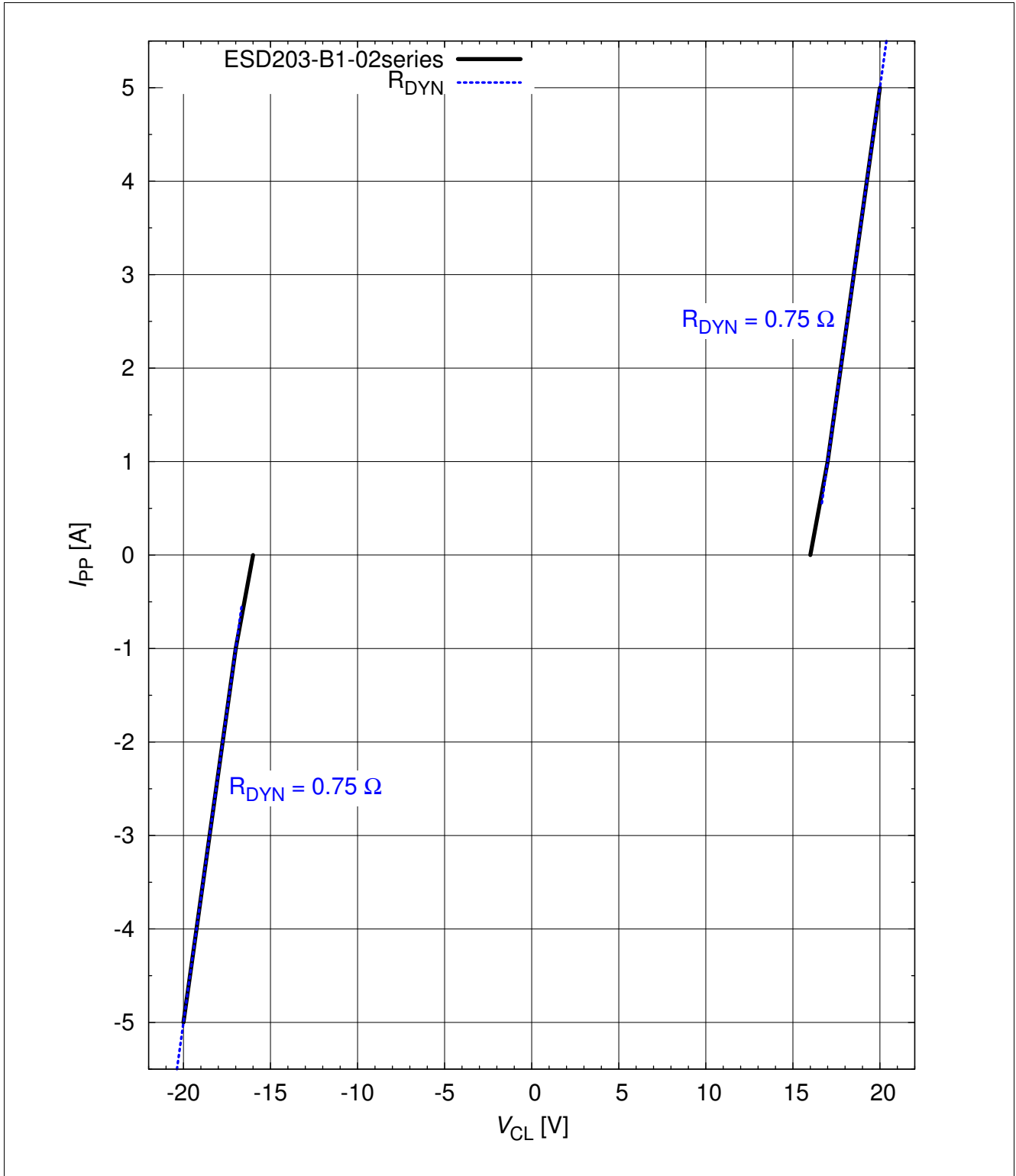

Figure 3-4 Pulse current (IEC61000-4-5) versus clamping voltage: $I_{PP} = f(V_{CL})$

Typical Characteristics at $T_A = 25\text{ }^\circ\text{C}$, unless otherwise specified

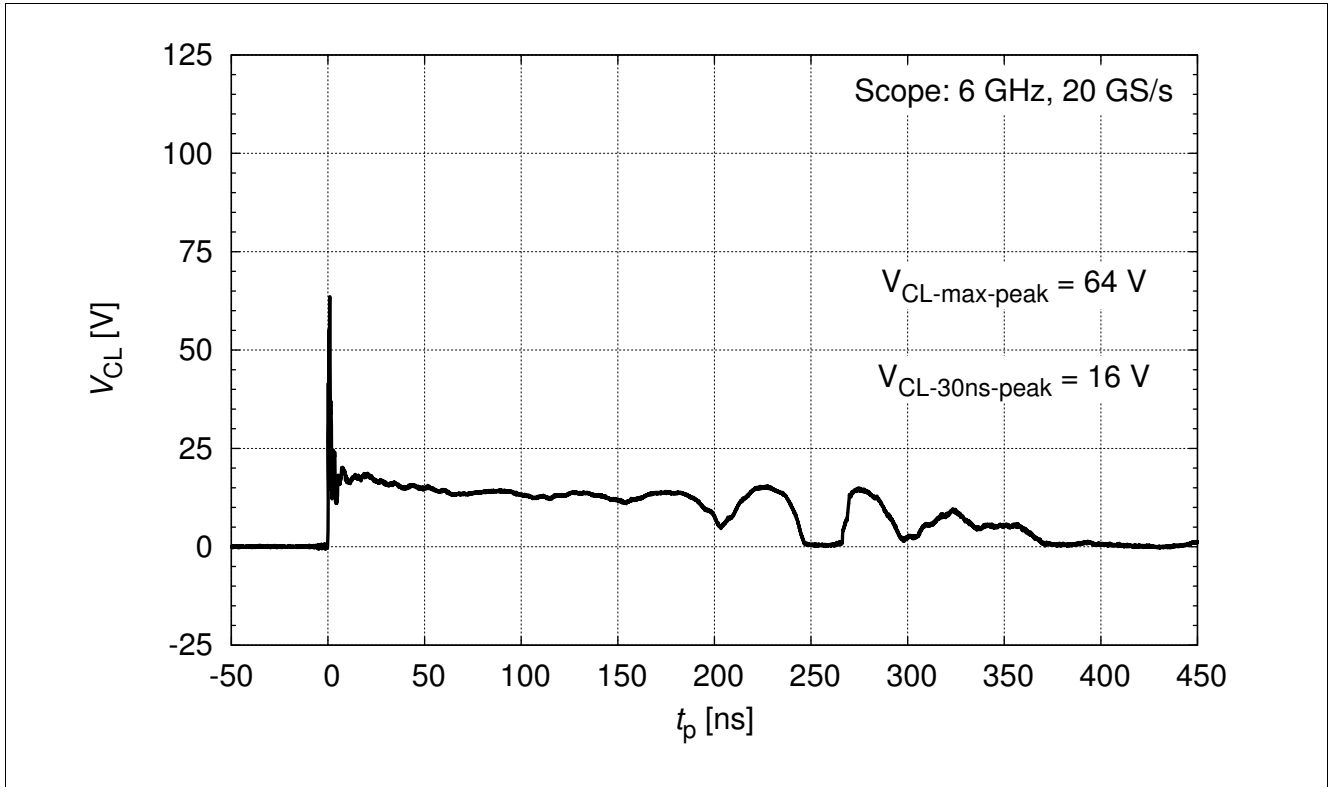

Figure 3-5 IEC61000-4-2 : $V_{CL} = f(t)$, 8 kV positive pulse from pin 1 to pin 2

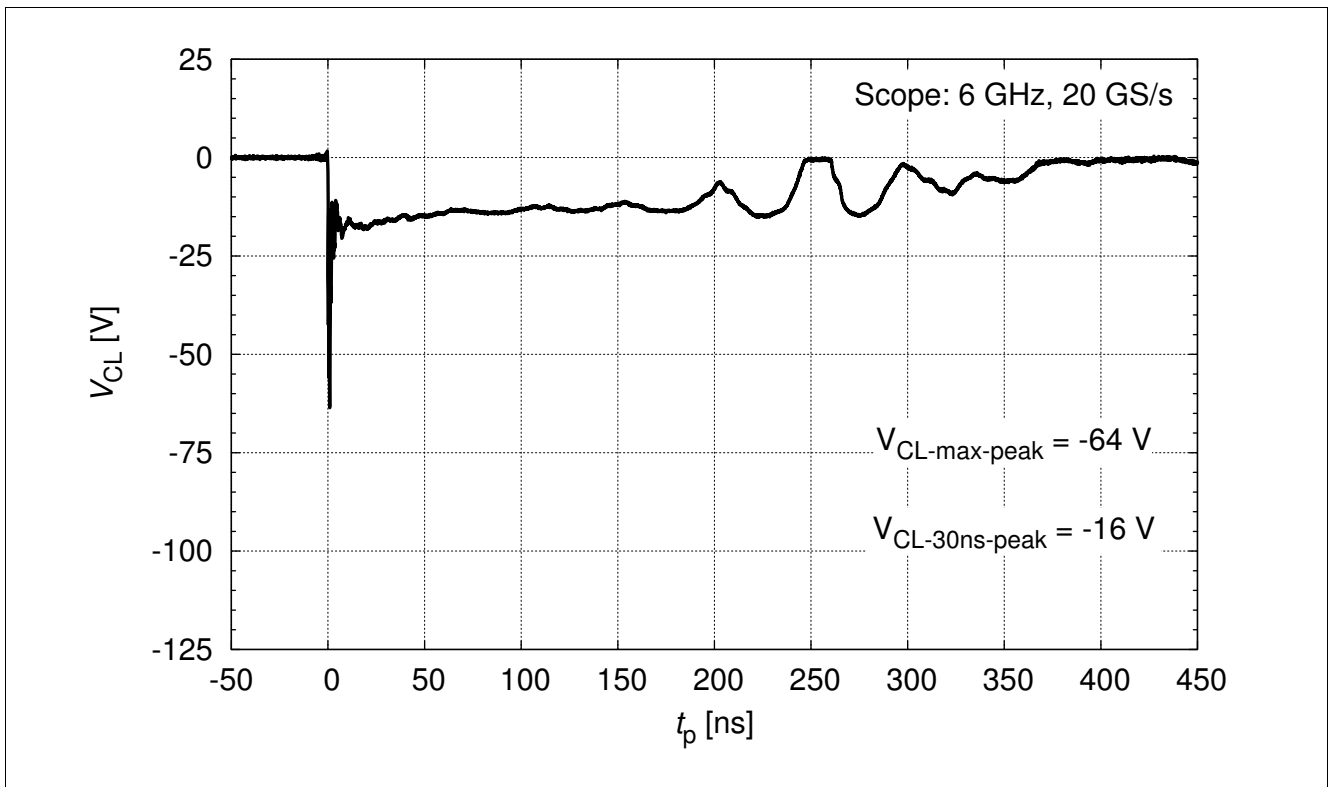

Figure 3-6 IEC61000-4-2 : $V_{CL} = f(t)$, 8 kV negative pulse from pin 1 to pin 2

Typical Characteristics at $T_A = 25\text{ }^\circ\text{C}$, unless otherwise specified

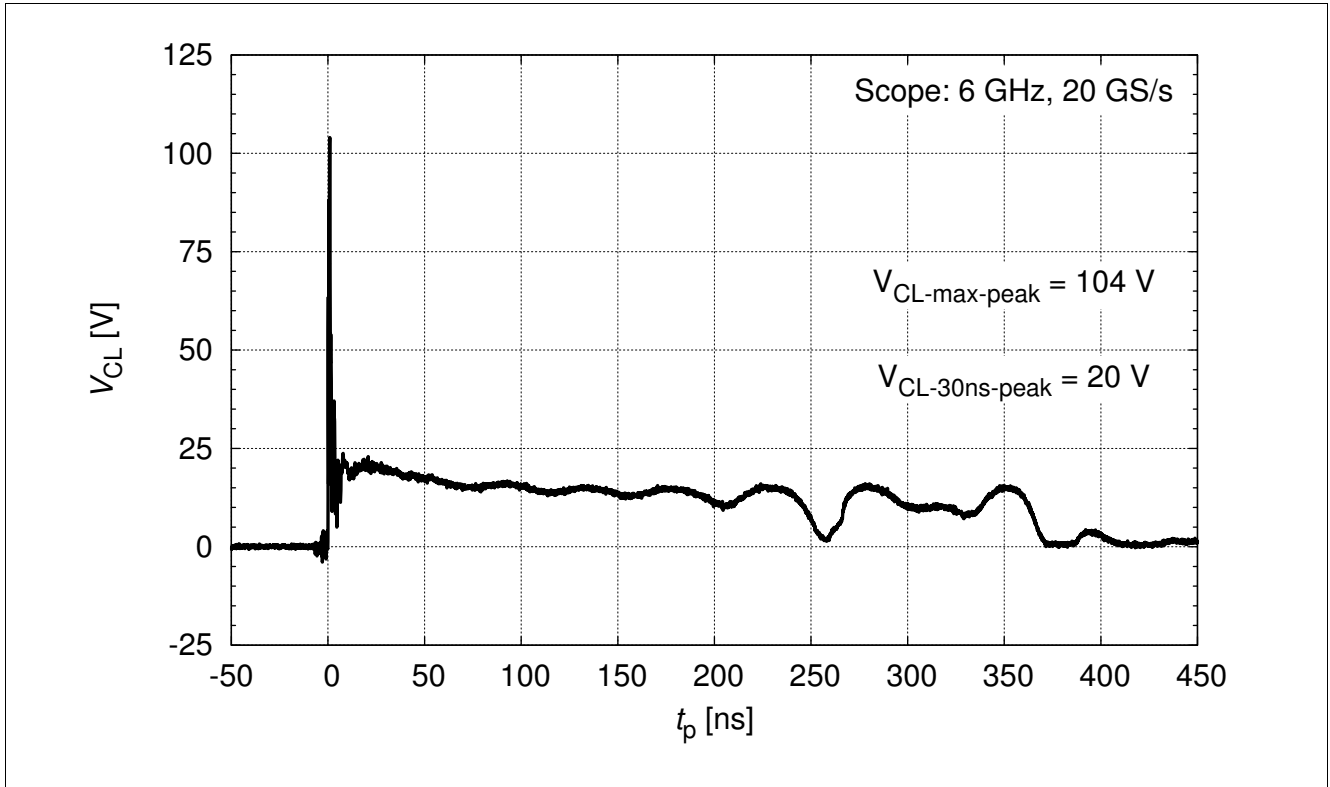

Figure 3-7 IEC61000-4-2 : $V_{CL} = f(t)$, 15 kV positive pulse from pin 1 to pin 2

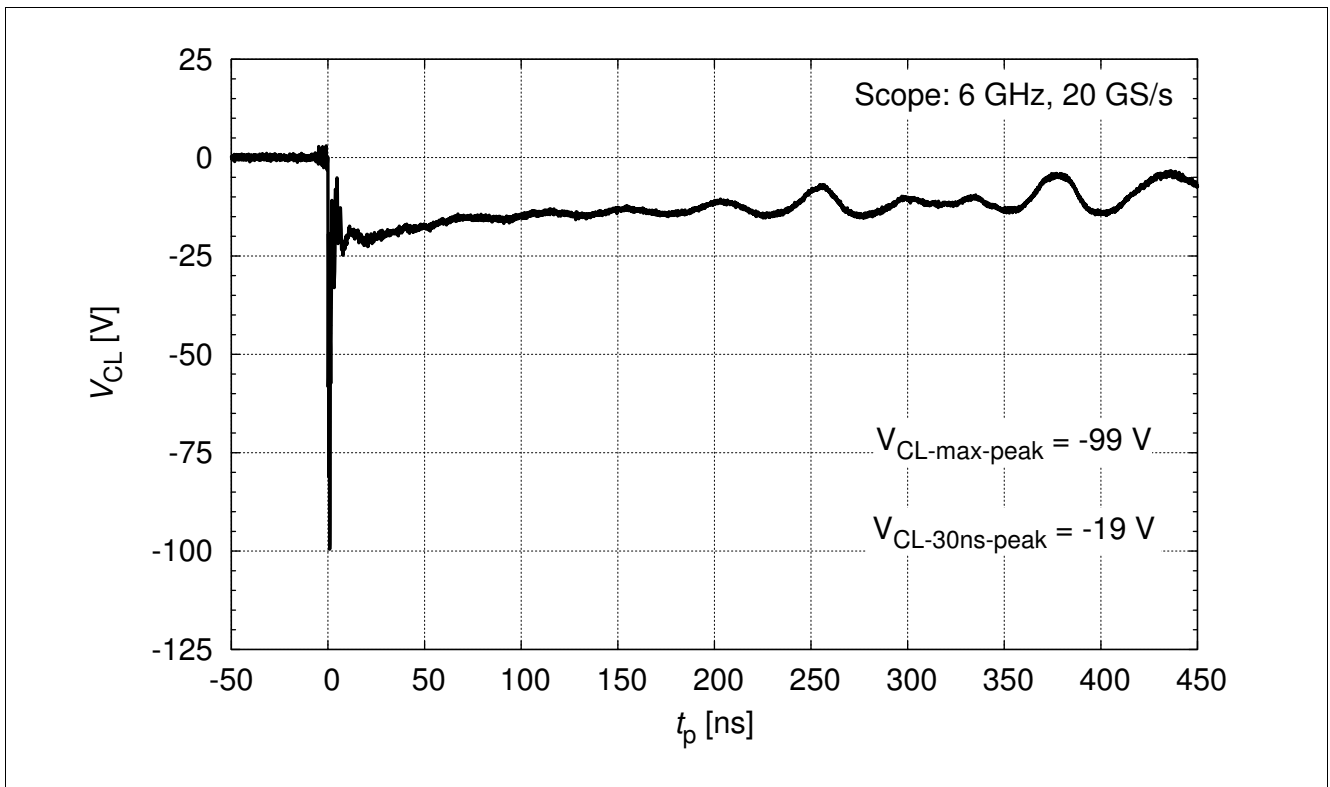

Figure 3-8 IEC61000-4-2 : $V_{CL} = f(t)$, 15 kV negative pulse from pin 1 to pin 2

4 Package Information

4.1 TSSLP-2-4

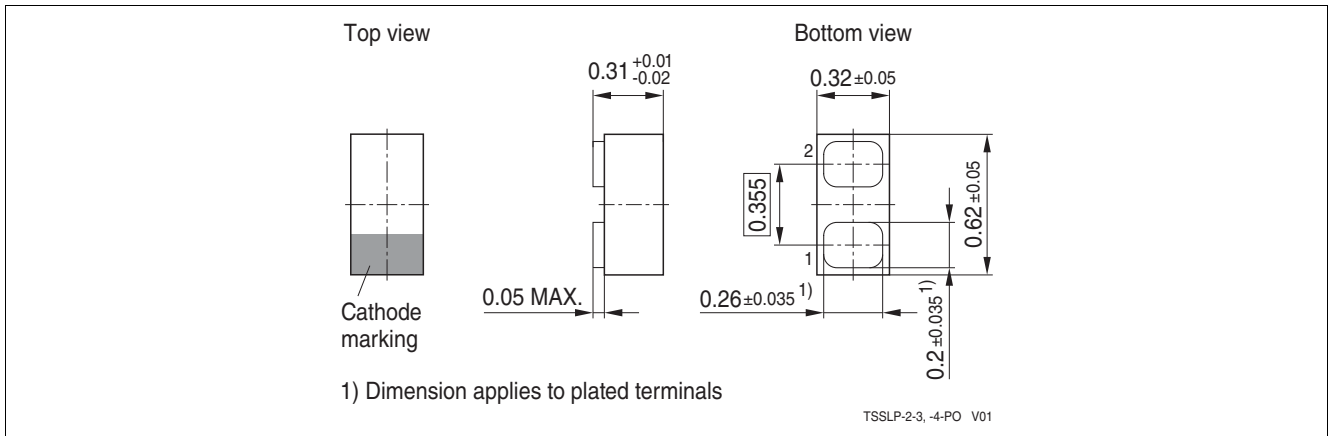

Figure 4-1 TSSLP-2-4: Package outline (dimension in mm)

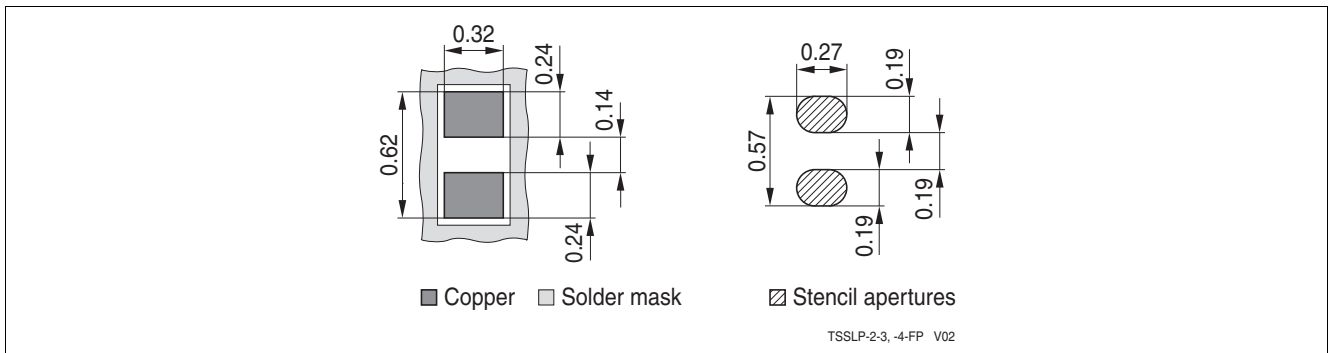

Figure 4-2 TSSLP-2-4: Footprint (dimension in mm)

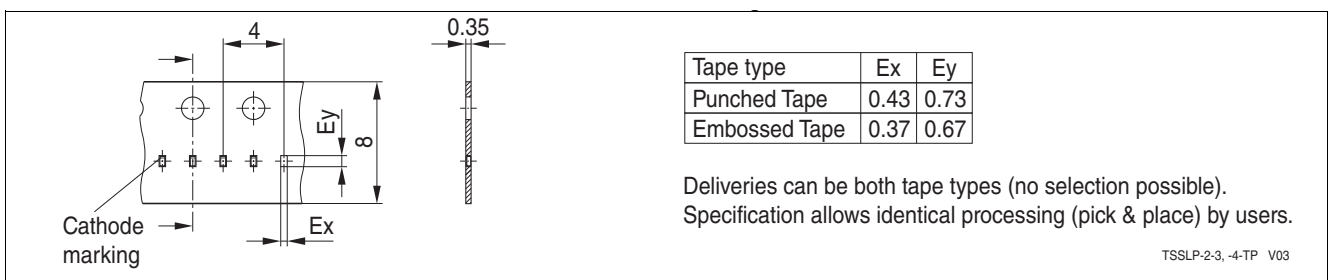

Figure 4-3 TSSLP-2-4: Tape and reel (dimension in mm)

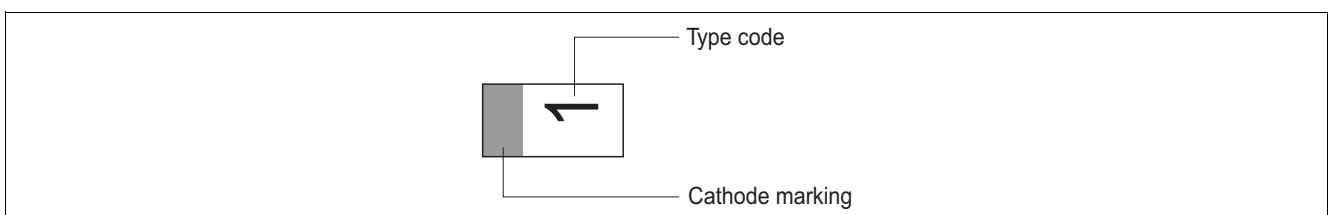

Figure 4-4 TSSLP-2-4: Marking example

4.2 TSLP-2-20

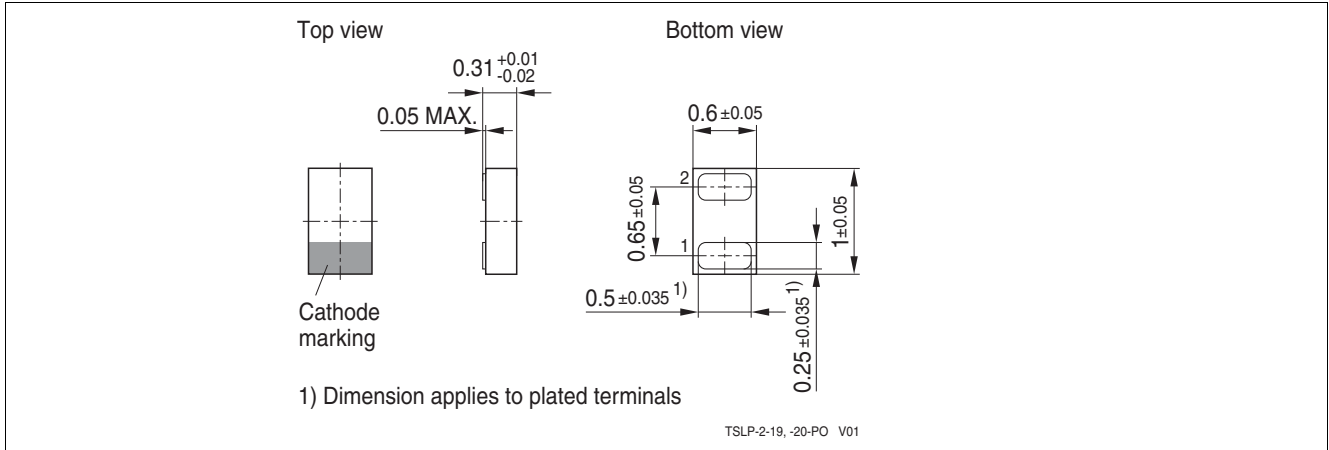

Figure 4-5 TSLP-2-20: Package outline(dimension in mm), proposal

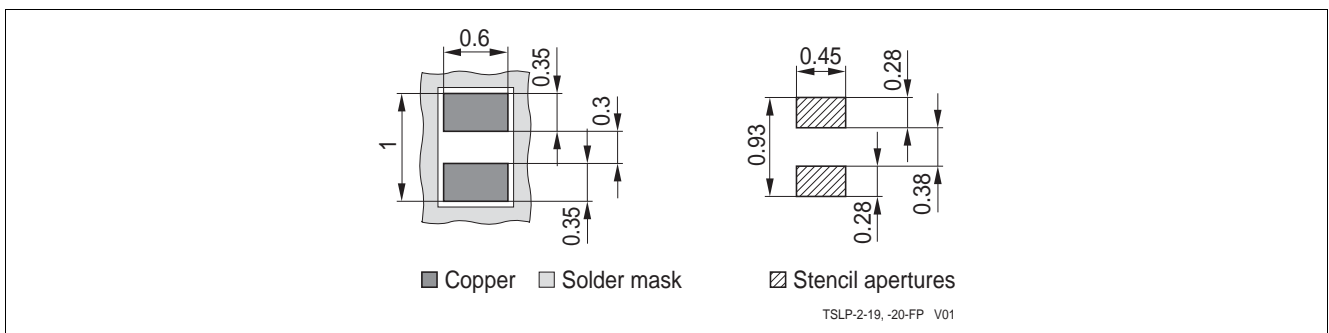

Figure 4-6 TSLP-2-20: Footprint (dimension in mm), proposal

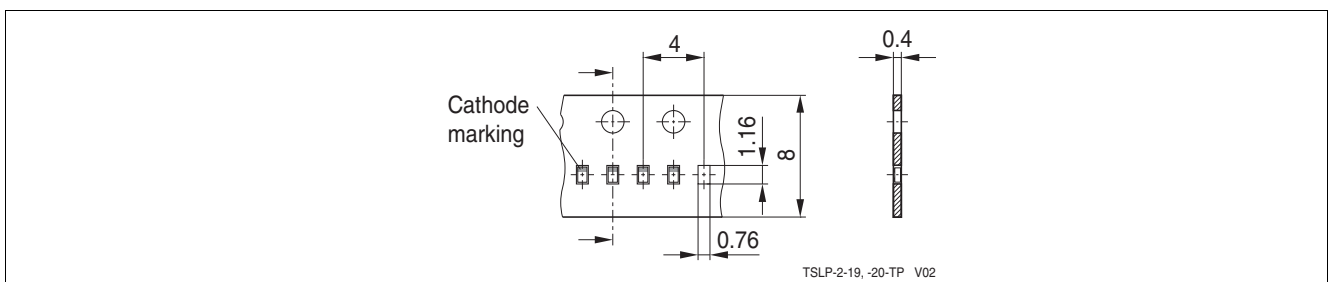

Figure 4-7 TSLP-2-20: Tape information (dimension in mm), proposal

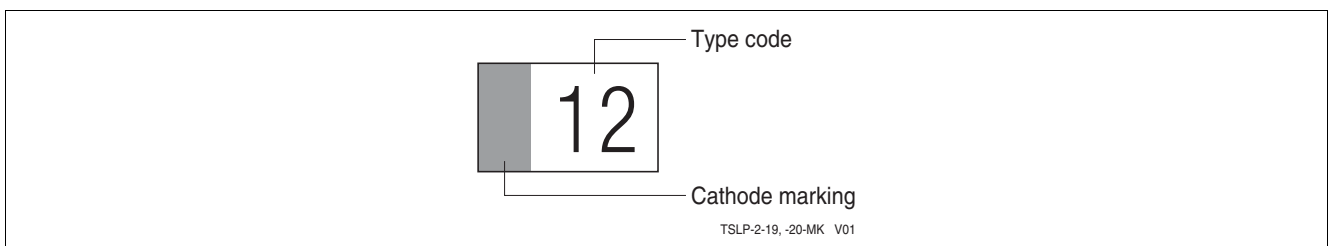

Figure 4-8 TSLP-2-20: Marking example

References

- [1] Infineon AG - **Application Note AN210**: Effective ESD Protection design at System Level Using VF-TLP Characterization Methodology

www.infineon.com

Published by Infineon Technologies AG

Mouser Electronics

Authorized Distributor

Click to View Pricing, Inventory, Delivery & Lifecycle Information:

[Infineon:](#)

[ESD203B102ELE6327XTMA1](#) [ESD203B102ELSE6327XTSA1](#)