

SIPMOS® Small-Signal-Transistor
Feature

- P-Channel
- Enhancement mode
- Logic Level
- dv/dt rated
- Pb-free lead plating; RoHS compliant
- Qualified according to AEC Q101
- Halogen-free according to IEC 61249-2-21

Product Summary

V_{DS}	-100	V
$R_{DS(on)}$	1.8	Ω
I_D	-0.68	A

PG-SOT223-4-1

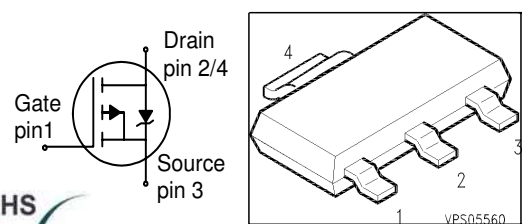

Type	Package	Tape and Reel Information	Marking	Packaging
BSP316P	PG-SOT223-4-1	H6327: 1000 pcs/reel	BSP316P	Non dry

Maximum Ratings, at $T_j = 25\text{ }^\circ\text{C}$, unless otherwise specified

Parameter	Symbol	Value	Unit
Continuous drain current $T_A=25\text{ }^\circ\text{C}$ $T_A=70\text{ }^\circ\text{C}$	I_D	-0.68 -0.54	A
Pulsed drain current $T_A=25\text{ }^\circ\text{C}$	$I_{D\text{ puls}}$	-2.72	
Reverse diode dv/dt $I_S=-0.68\text{ A}$, $V_{DS}=-48\text{ V}$, $di/dt=-200\text{ A}/\mu\text{s}$, $T_{j\text{ max}}=150\text{ }^\circ\text{C}$	dv/dt	6	kV/ μs
Gate source voltage	V_{GS}	± 20	V
Power dissipation $T_A=25\text{ }^\circ\text{C}$	P_{tot}	1.8	W
Operating and storage temperature	T_j, T_{stg}	-55... +150	$^\circ\text{C}$
IEC climatic category; DIN IEC 68-1		55/150/56	
ESD Class JESD22-A114-HBM		Class 1a	

Thermal Characteristics

Parameter	Symbol	Values			Unit
		min.	typ.	max.	
Characteristics					
Thermal resistance, junction - soldering point (Pin 4)	R_{thJS}	-	15	25	K/W
SMD version, device on PCB: @ min. footprint @ 6 cm ² cooling area ¹⁾	R_{thJA}	- -	80 48	115 70	

Electrical Characteristics, at $T_j = 25\text{ }^\circ\text{C}$, unless otherwise specified

Parameter	Symbol	Values			Unit
		min.	typ.	max.	
Static Characteristics					
Drain-source breakdown voltage $V_{GS}=0, I_D=-250\mu\text{A}$	$V_{(BR)DSS}$	-100	-	-	V
Gate threshold voltage, $V_{GS} = V_{DS}$ $I_D=-170\mu\text{A}$	$V_{GS(th)}$	-1	-1.5	-2	
Zero gate voltage drain current $V_{DS}=-100\text{V}, V_{GS}=0, T_j=25^\circ\text{C}$ $V_{DS}=-100\text{V}, V_{GS}=0, T_j=150^\circ\text{C}$	I_{DSS}	- -	-0.1 -10	-0.2 -100	μA
Gate-source leakage current $V_{GS}=-20\text{V}, V_{DS}=0$	I_{GSS}	-	-10	-100	
Drain-source on-state resistance $V_{GS}=-4.5\text{V}, I_D=-0.61\text{A}$	$R_{DS(on)}$	-	1.5	2.3	Ω
Drain-source on-state resistance $V_{GS}=-10\text{V}, I_D=-0.68\text{A}$	$R_{DS(on)}$	-	1.4	1.8	

¹⁾ Device on 40mm*40mm*1.5mm epoxy PCB FR4 with 6cm² (one layer, 70 μm thick) copper area for drain connection. PCB is vertical without blown air.

Electrical Characteristics, at $T_j = 25\text{ }^\circ\text{C}$, unless otherwise specified

Parameter	Symbol	Conditions	Values			Unit
			min.	typ.	max.	
Dynamic Characteristics						
Transconductance	g_{fs}	$ V_{DS} \geq 2 * I_D * R_{DS(on)max}$ $I_D = -0.54\text{A}$	0.5	1	-	S
Input capacitance	C_{iss}	$V_{GS} = 0, V_{DS} = -25\text{V},$ $f = 1\text{MHz}$	-	117	146	pF
Output capacitance	C_{oss}		-	27.7	34.5	
Reverse transfer capacitance	C_{rss}		-	12	15	
Turn-on delay time	$t_{d(on)}$	$V_{DD} = -50\text{V}, V_{GS} = -10\text{V},$ $I_D = -0.68\text{A}, R_G = 6\Omega$	-	4.7	7	ns
Rise time	t_r		-	7.5	11.2	
Turn-off delay time	$t_{d(off)}$		-	67.4	101	
Fall time	t_f		-	25.9	38.9	
Gate Charge Characteristics						
Gate to source charge	Q_{gs}	$V_{DD} = -80\text{V}, I_D = -0.68\text{A}$	-	-0.2	-0.3	nC
Gate to drain charge	Q_{gd}		-	-1.87	-2.8	
Gate charge total	Q_g	$V_{DD} = -80\text{V}, I_D = -0.68\text{A},$ $V_{GS} = 0 \text{ to } -10\text{V}$	-	-5.1	-6.4	
Gate plateau voltage	$V_{(plateau)}$	$V_{DD} = -80\text{V}, I_D = -0.68\text{A}$	-	-2.7	-	V
Reverse Diode						
Inverse diode continuous forward current	I_S	$T_A = 25^\circ\text{C}$	-	-	-0.68	A
Inv. diode direct current, pulsed	I_{SM}		-	-	-2.72	
Inverse diode forward voltage	V_{SD}	$V_{GS} = 0, I_F = -0.68\text{A}$	-	-0.85	-1.2	V
Reverse recovery time	t_{rr}	$V_R = -50\text{V}, I_F = I_S,$ $di_F/dt = 100\text{A}/\mu\text{s}$	-	44.2	55.3	ns
Reverse recovery charge	Q_{rr}		-	56.3	70.4	

1 Power dissipation

$$P_{\text{tot}} = f(T_A)$$

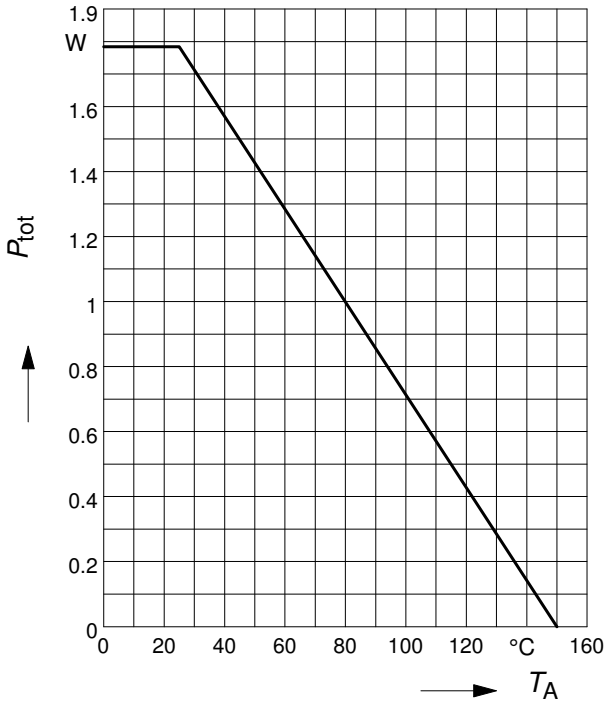

2 Drain current

$$I_D = f(T_A)$$

parameter: $|V_{GS}| \geq 10V$

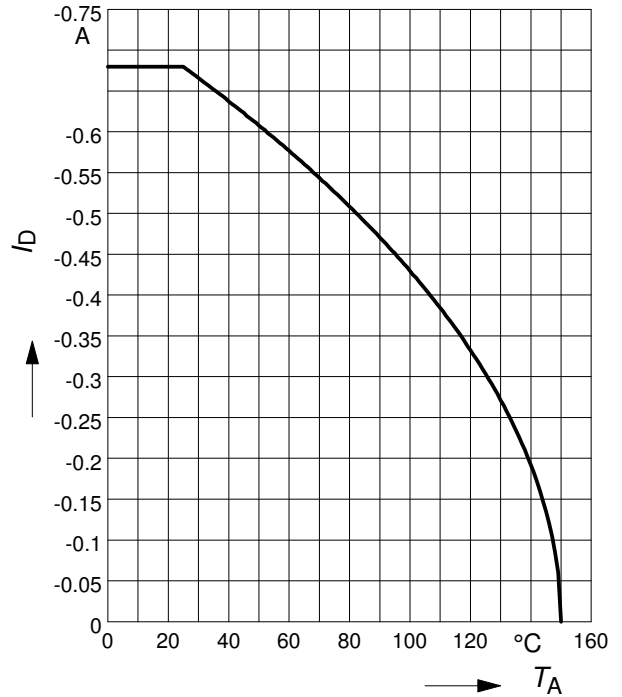

3 Safe operating area

$$I_D = f(V_{DS})$$

parameter: $D = 0$, $T_A = 25^\circ\text{C}$

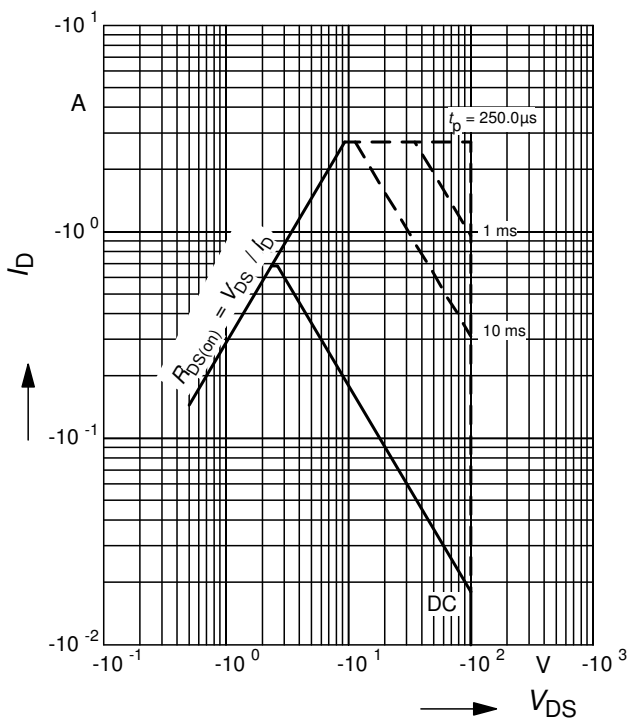

4 Transient thermal impedance

$$Z_{\text{thJA}} = f(t_p)$$

parameter: $D = t_p/T$

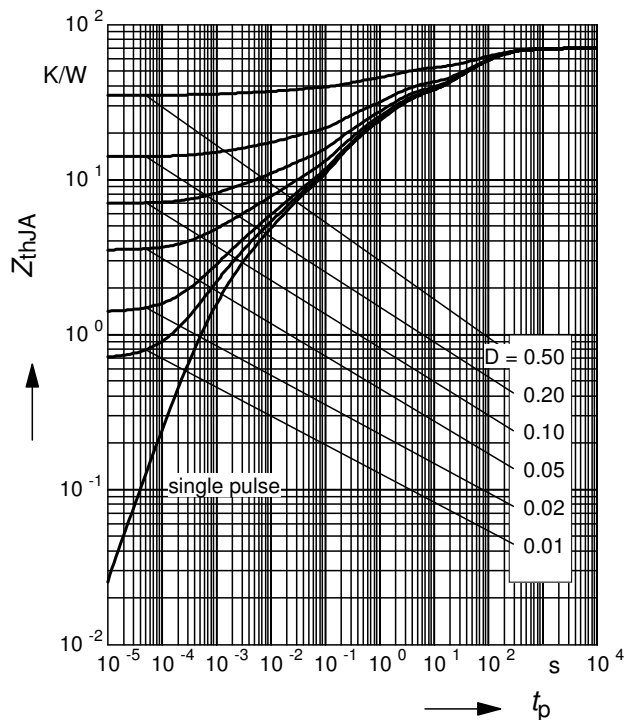

5 Typ. output characteristic

$I_D = f(V_{DS})$

parameter: $T_j = 25^\circ\text{C}$, $-V_{GS}$

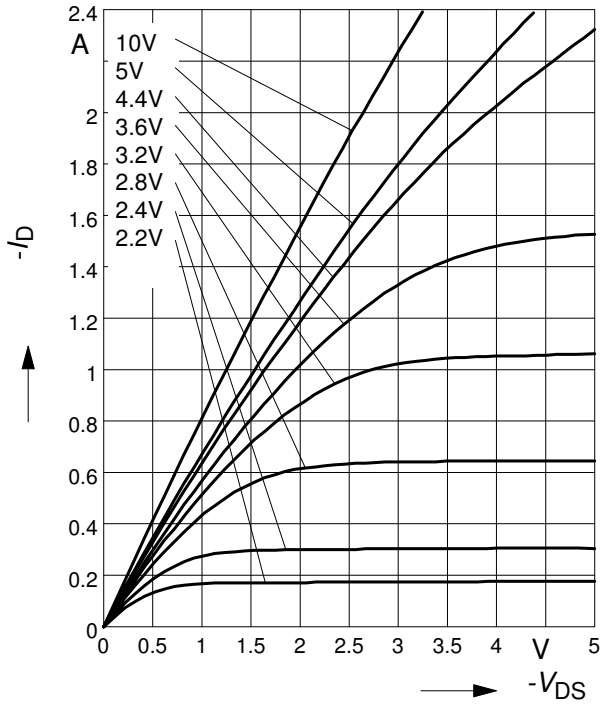

6 Typ. drain-source on resistance

$R_{DS(on)} = f(I_D)$

parameter: $T_j = 25^\circ\text{C}$, $-V_{GS}$

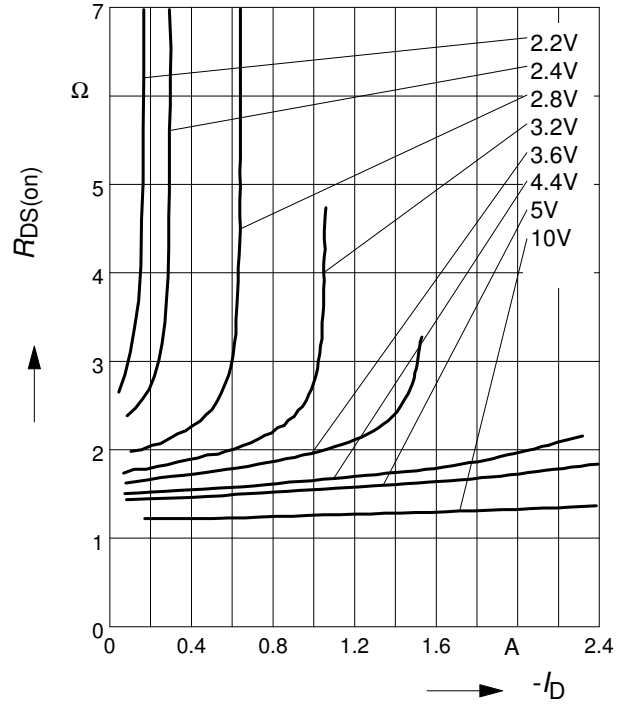

7 Typ. transfer characteristics

$I_D = f(V_{GS})$; $|V_{DS}| \geq 2 \times |I_D| \times R_{DS(on)max}$

parameter: $T_j = 25^\circ\text{C}$

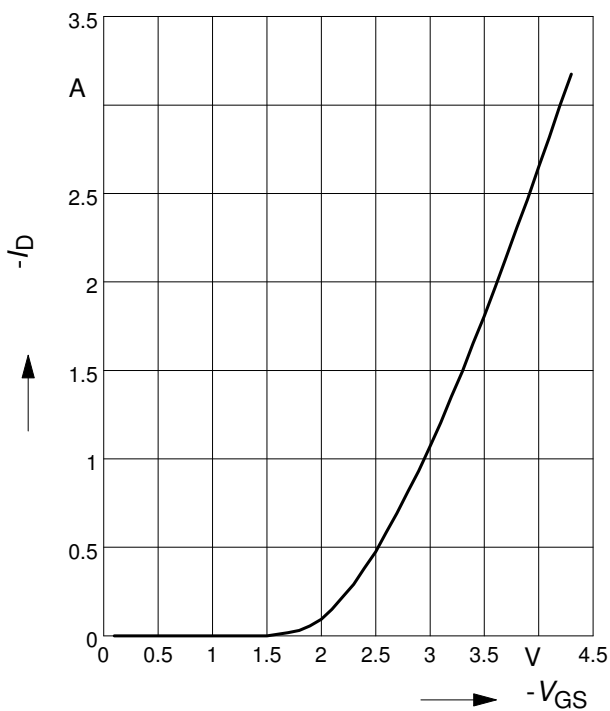

8 Typ. forward transconductance

$g_{fs} = f(I_D)$

parameter: $T_j = 25^\circ\text{C}$

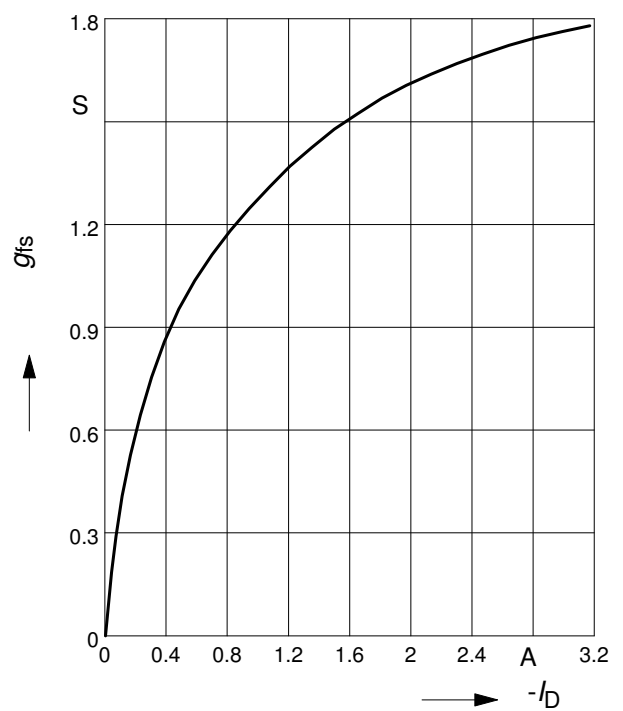

9 Drain-source on-state resistance

$$R_{DS(on)} = f(T_j)$$

parameter : $I_D = -0.68 \text{ A}$, $V_{GS} = -10 \text{ V}$

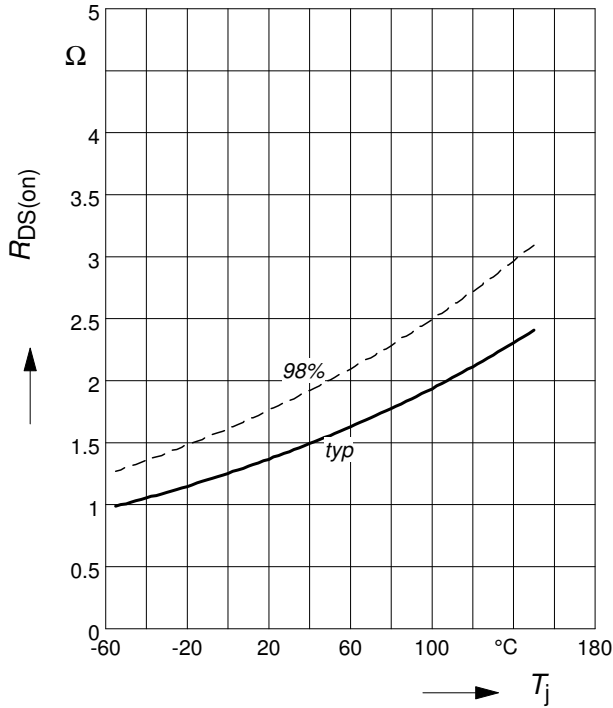

10 Typ. gate threshold voltage

$$V_{GS(th)} = f(T_j)$$

parameter: $V_{GS} = V_{DS}$

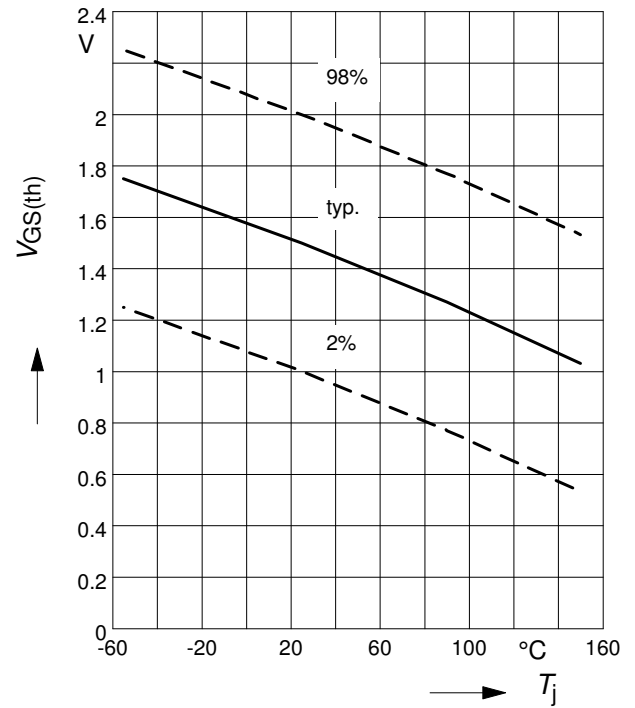

11 Typ. capacitances

$$C = f(V_{DS})$$

parameter: $V_{GS}=0$, $f=1 \text{ MHz}$, $T_j = 25 \text{ }^\circ\text{C}$

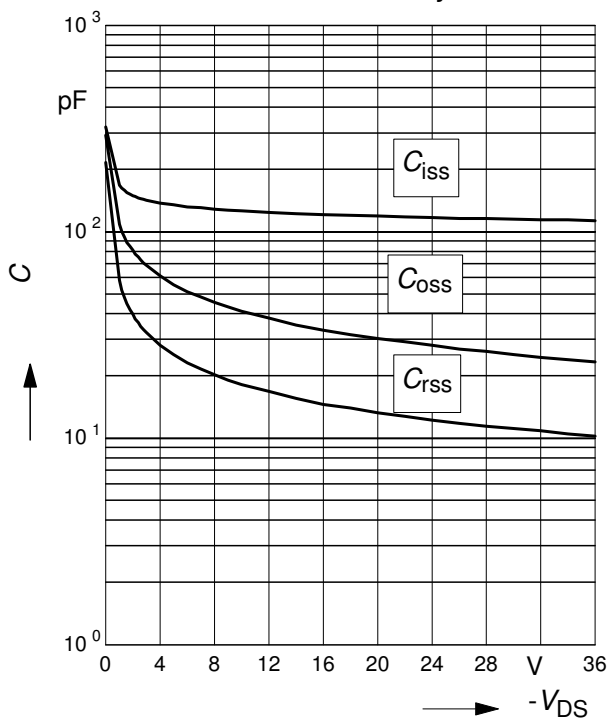

12 Forward character. of reverse diode

$$I_F = f(V_{SD})$$

parameter: T_j

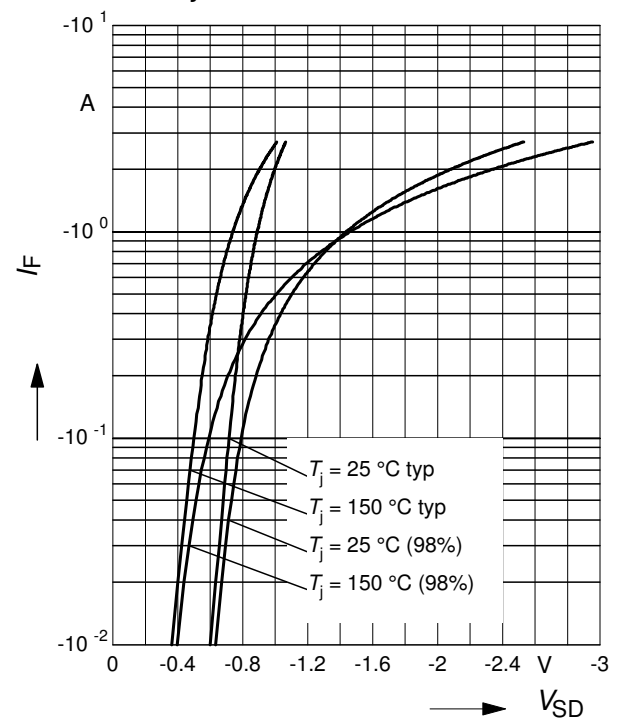

13 Typ. gate charge

$$V_{GS} = f(Q_{Gate})$$

parameter: $I_D = -0.68$ A pulsed, $T_j = 25$ °C

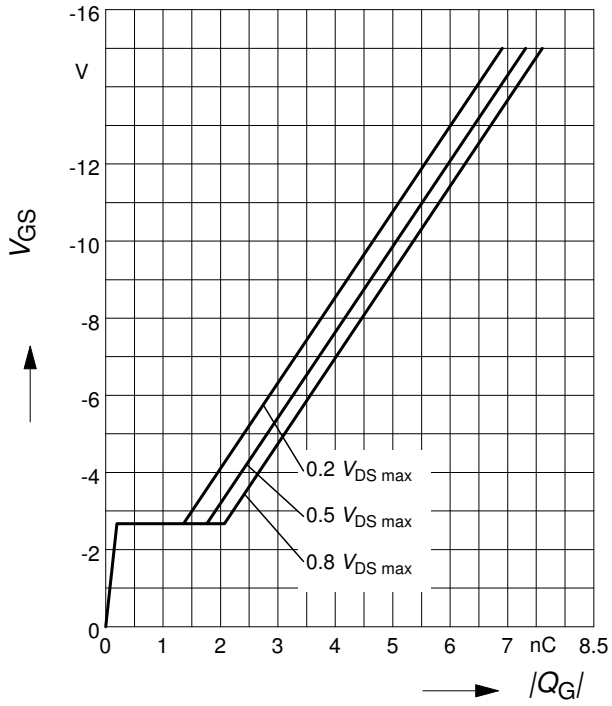

14 Drain-source breakdown voltage

$$V_{(BR)DSS} = f(T_j)$$

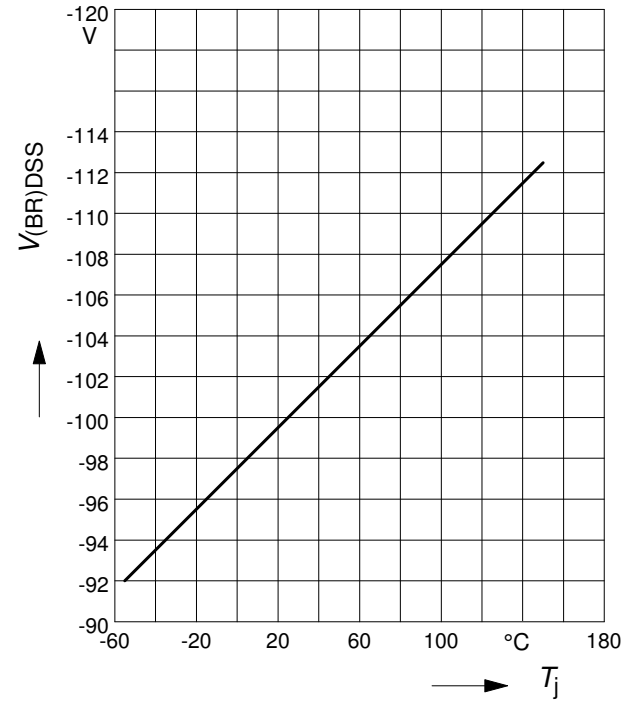

Package Outline SOT-223

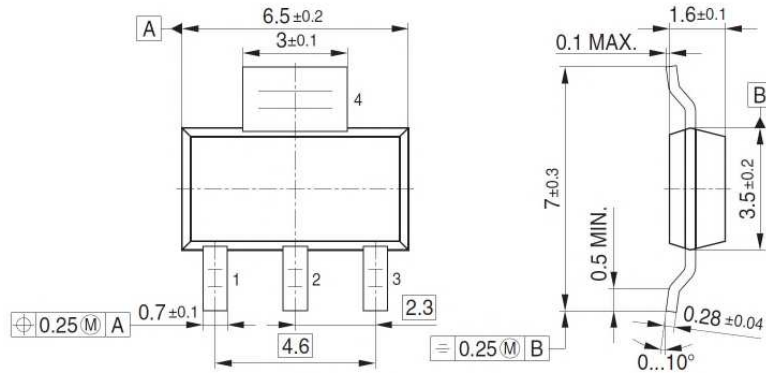

Footprint

Soldering type: Reflow soldering

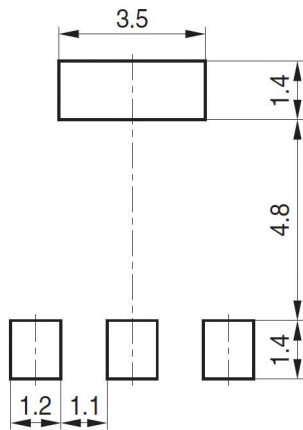

Soldering type: Wave soldering

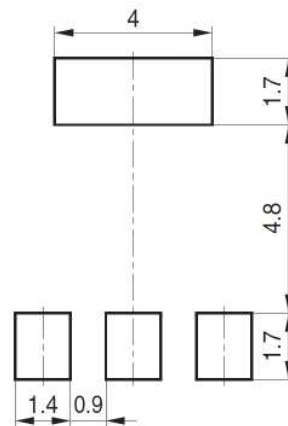

Tape and Reel

Reel $\varnothing 180$ mm: 1.000 Pieces/Reel
Reels/Box: 1 x 1.000 = 1.000

Reel $\varnothing 330$ mm: 4.000 Pieces/Reel
Reels/Box: 1 x 4.000 = 4.000

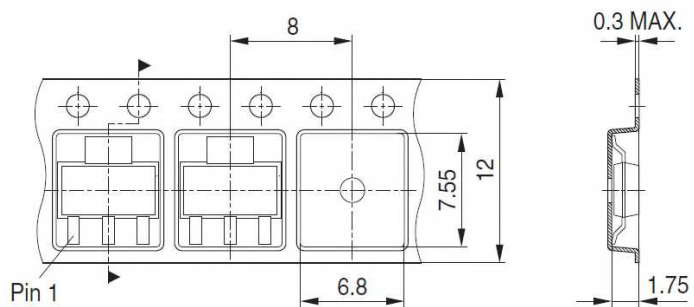

Dimensions in mm

-100V SIPMOS Small Signal Transistor

BSP316P

Revision History

BSP316P

Revision: 2016-06-10, Rev. 2.0

Previous Revision

Revision	Date	Subjects (major changes since last revision)
2.0	2016-06-10	Release of final version

Trademarks of Infineon Technologies AG

AURIX™, C166™, CanPAK™, CIPOS™, CoolGaN™, CoolMOS™, CoolSET™, CoolSiC™, CORECONTROL™, CROSSAVE™, DAVE™, DI-POL™, DrBlade™, EasyPIM™, EconoBRIDGE™, EconoDUAL™, EconoPACK™, EconoPIM™, EiceDRIVER™, eupec™, FCOS™, HITFET™, HybridPACK™, Infineon™, ISOFACE™, IsoPACK™, i-Wafer™, MIPAQ™, ModSTACK™, my-d™, NovalithIC™, OmniTune™, OPTIGA™, OptiMOS™, ORIGA™, POWERCODE™, PRIMARION™, PrimePACK™, PrimeSTACK™, PROFET™, PRO-SIL™, RASIC™, REAL3™, ReverSave™, SatRIC™, SIEGET™, SIPMOS™, SmartLEWIS™, SOLID FLASH™, SPOC™, TEMPFET™, thinQ!™, TRENCHSTOP™, TriCore™.

Trademarks updated August 2015

Other Trademarks

All referenced product or service names and trademarks are the property of their respective owners.

We Listen to Your Comments

Any information within this document that you feel is wrong, unclear or missing at all? Your feedback will help us to continuously improve the quality of this document. Please send your proposal (including a reference to this document) to:

erratum@infineon.com

Published by

Infineon Technologies AG

81726 München, Germany

© 2016 Infineon Technologies AG

All Rights Reserved.

Legal Disclaimer

The information given in this document shall in no event be regarded as a guarantee of conditions or characteristics. With respect to any examples or hints given herein, any typical values stated herein and/or any information regarding the application of the device, Infineon Technologies hereby disclaims any and all warranties and liabilities of any kind, including without limitation, warranties of non-infringement of intellectual property rights of any third party.

Information

For further information on technology, delivery terms and conditions and prices please contact your nearest Infineon Technologies Office (www.infineon.com).

Warnings

Due to technical requirements, components may contain dangerous substances. For information on the types in question, please contact the nearest Infineon Technologies Office.

The Infineon Technologies component described in this Data Sheet may be used in life-support devices or systems and/or automotive, aviation and aerospace applications or systems only with the express written approval of Infineon Technologies, if a failure of such components can reasonably be expected to cause the failure of that life-support, automotive, aviation and aerospace device or system or to affect the safety or effectiveness of that device or system. Life support devices or systems are intended to be implanted in the human body or to support and/or maintain and sustain and/or protect human life. If they fail, it is reasonable to assume that the health of the user or other persons may be endangered.

Mouser Electronics

Authorized Distributor

Click to View Pricing, Inventory, Delivery & Lifecycle Information:

[Infineon:](#)

[BSP316P L6327](#) [BSP316P H6327](#)