

**HiPerFRED<sup>2</sup>**

$V_{RRM}$	=	400V
$I_{FAV}$	=	30A
$t_{rr}$	=	45ns

High Performance Fast Recovery Diode  
 Low Loss and Soft Recovery  
 Single Diode

Part number

**DPG30I400HA**

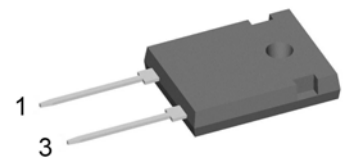

Backside: cathode

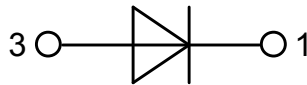
**Features / Advantages:**

- Planar passivated chips
- Very low leakage current
- Very short recovery time
- Improved thermal behaviour
- Very low  $I_{rm}$ -values
- Very soft recovery behaviour
- Avalanche voltage rated for reliable operation
- Soft reverse recovery for low EMI/RFI
- Low  $I_{rm}$  reduces:
  - Power dissipation within the diode
  - Turn-on loss in the commutating switch

**Applications:**

- Antiparallel diode for high frequency switching devices
- Antisaturation diode
- Snubber diode
- Free wheeling diode
- Rectifiers in switch mode power supplies (SMPS)
- Uninterruptible power supplies (UPS)

**Package: TO-247**

- Industry standard outline
- RoHS compliant
- Epoxy meets UL 94V-0

Fast Diode				Ratings		
Symbol	Definition	Conditions	min.	typ.	max.	Unit
$V_{RSM}$	max. non-repetitive reverse blocking voltage	$T_{VJ} = 25^{\circ}C$			400	V
$V_{RRM}$	max. repetitive reverse blocking voltage	$T_{VJ} = 25^{\circ}C$			400	V
$I_R$	reverse current, drain current	$V_R = 400 V$	$T_{VJ} = 25^{\circ}C$		1	$\mu A$
		$V_R = 400 V$	$T_{VJ} = 150^{\circ}C$		0.2	mA
$V_F$	forward voltage drop	$I_F = 30 A$	$T_{VJ} = 25^{\circ}C$		1.41	V
					1.69	V
		$I_F = 60 A$	$T_{VJ} = 150^{\circ}C$		1.13	V
					1.46	V
$I_{FAV}$	average forward current	$T_C = 135^{\circ}C$ rectangular $d = 0.5$	$T_{VJ} = 175^{\circ}C$		30	A
$V_{FO}$	threshold voltage	} for power loss calculation only	$T_{VJ} = 175^{\circ}C$		0.76	V
$r_F$	slope resistance				10.7	m $\Omega$
$R_{thJC}$	thermal resistance junction to case				0.95	K/W
$R_{thCH}$	thermal resistance case to heatsink			0.25		K/W
$P_{tot}$	total power dissipation		$T_C = 25^{\circ}C$		160	W
$I_{FSM}$	max. forward surge current	$t = 10 ms; (50 Hz), sine; V_R = 0 V$	$T_{VJ} = 45^{\circ}C$		360	A
$C_J$	junction capacitance	$V_R = 200 V \quad f = 1 MHz$	$T_{VJ} = 25^{\circ}C$		32	pF
$I_{RM}$	max. reverse recovery current	} $I_F = 30 A; V_R = 270 V$ $-di_F/dt = 200 A/\mu s$	$T_{VJ} = 25^{\circ}C$		4	A
$t_{rr}$	reverse recovery time		$T_{VJ} = 125^{\circ}C$		8.5	A
			$T_{VJ} = 25^{\circ}C$		45	ns
			$T_{VJ} = 125^{\circ}C$		85	ns

Package TO-247			Ratings			
Symbol	Definition	Conditions	min.	typ.	max.	Unit
$I_{RMS}$	RMS current	per terminal			50	A
$T_{VJ}$	virtual junction temperature		-55		175	°C
$T_{op}$	operation temperature		-55		150	°C
$T_{stg}$	storage temperature		-55		150	°C
<b>Weight</b>				6		g
$M_D$	mounting torque		0.8		1.2	Nm
$F_C$	mounting force with clip		20		120	N

### Product Marking

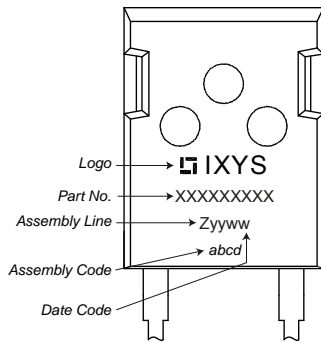

### Part number

- D = Diode
- P = HiPerFRED
- G = extreme fast
- 30 = Current Rating [A]
- I = Single Diode
- 400 = Reverse Voltage [V]
- HA = TO-247AD (2)

Ordering	Part Number	Marking on Product	Delivery Mode	Quantity	Code No.
Standard	DPG30I400HA	DPG30I400HA	Tube	30	507320

### Equivalent Circuits for Simulation

\* on die level

$T_{VJ} = 175\text{ °C}$

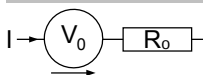

**Fast Diode**

$V_{0\max}$	threshold voltage	0.76	V
$R_{0\max}$	slope resistance *	8.1	mΩ

## Outlines TO-247

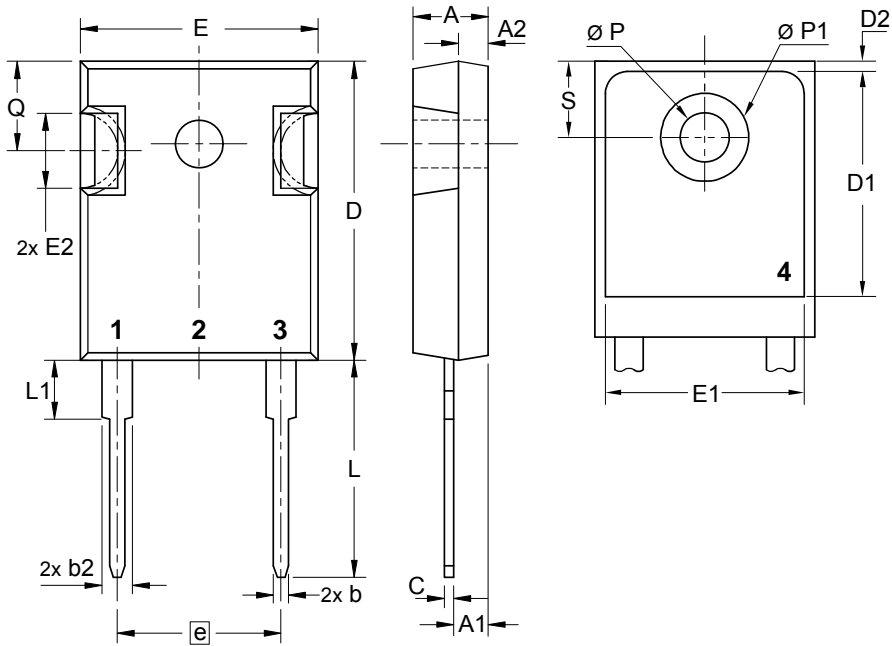

Sym.	Inches		Millimeter	
	min.	max.	min.	max.
A	0.185	0.209	4.70	5.30
A1	0.087	0.102	2.21	2.59
A2	0.059	0.098	1.50	2.49
D	0.819	0.845	20.79	21.45
E	0.610	0.640	15.48	16.24
E2	0.170	0.216	4.31	5.48
e	0.430 BSC		10.92 BSC	
L	0.780	0.800	19.80	20.30
L1	-	0.177	-	4.49
Ø P	0.140	0.144	3.55	3.65
Q	0.212	0.244	5.38	6.19
S	0.242 BSC		6.14 BSC	
b	0.039	0.055	0.99	1.40
b2	0.065	0.094	1.65	2.39
b4	0.102	0.135	2.59	3.43
c	0.015	0.035	0.38	0.89
D1	0.515	-	13.07	-
D2	0.020	0.053	0.51	1.35
E1	0.530	-	13.45	-
Ø P1	-	0.29	-	7.39



## Fast Diode

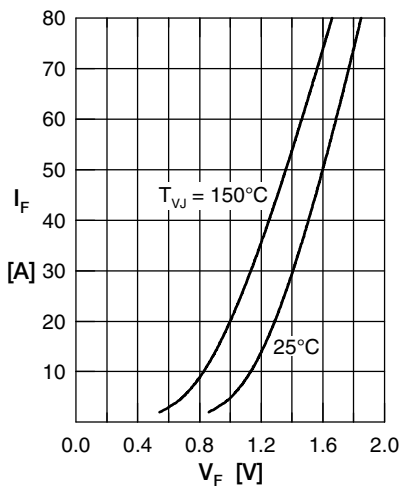

Fig. 1 Forward current  $I_F$  versus  $V_F$

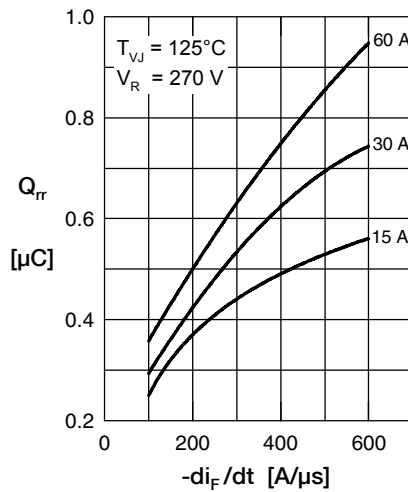

Fig. 2 Typ. reverse recov. charge  $Q_{rr}$  versus  $-di_F/dt$

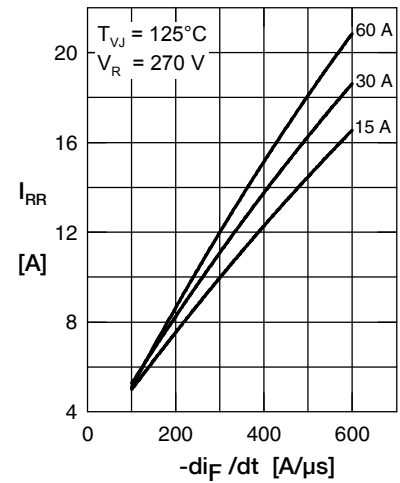

Fig. 3 Typ. reverse recovery current  $I_{RR}$  versus  $-di_F/dt$

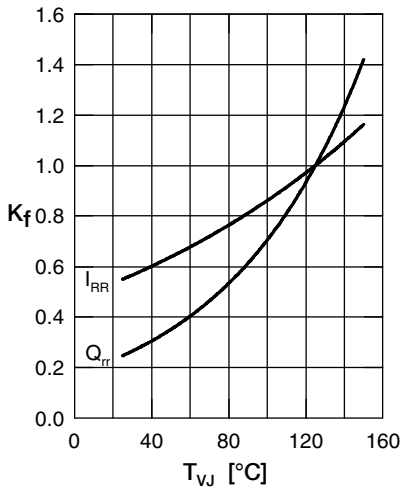

Fig. 4 Typ. dynamic parameters  $Q_{rr}$ ,  $I_{RR}$  versus  $T_{VJ}$

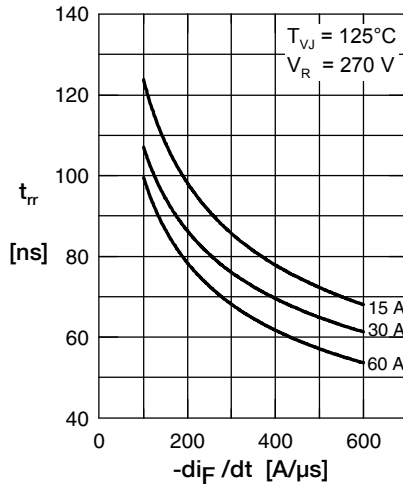

Fig. 5 Typ. reverse recov. time  $t_{rr}$  versus  $-di_F/dt$

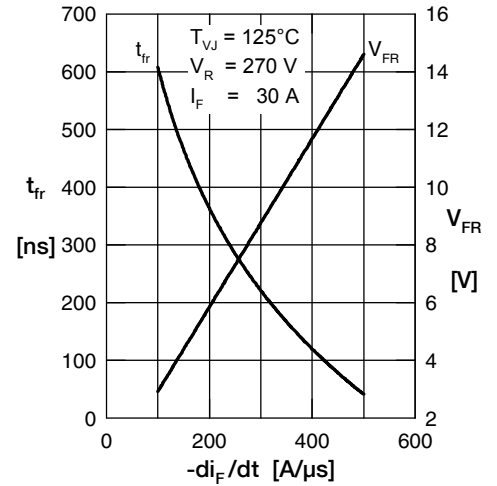

Fig. 6 Typ. forward recov. voltage  $V_{FR}$  & time  $t_{fr}$  versus  $di_F/dt$

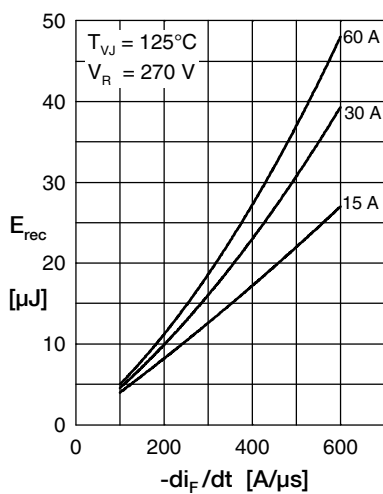

Fig. 7 Typ. recovery energy  $E_{rec}$  versus  $-di_F/dt$

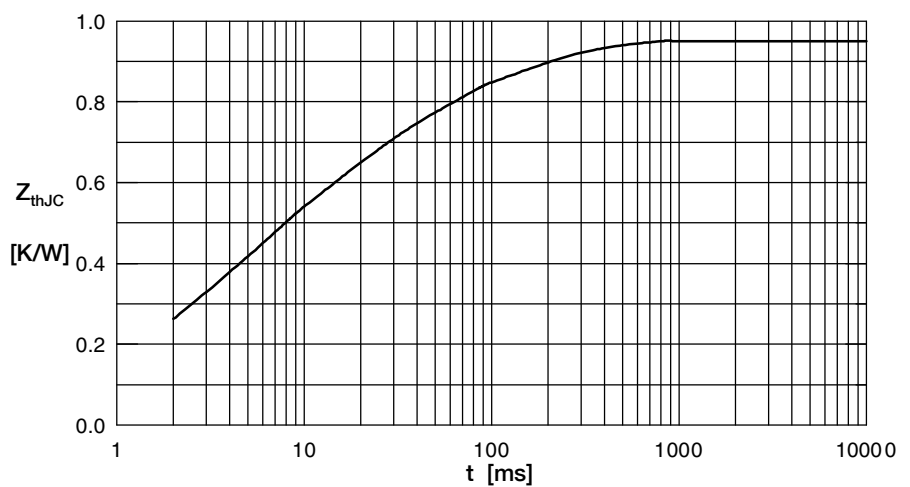

Fig. 8 Transient thermal impedance junction to case

# Mouser Electronics

Authorized Distributor

Click to View Pricing, Inventory, Delivery & Lifecycle Information:

[IXYS:](#)

[DPG30I400HA](#)