

Miniature Single-Cell, Fully Integrated Li-Ion, Li-Polymer Charge Management Controllers

Features

- Linear Charge Management Controller:
 - Integrated Pass Transistor
 - Integrated Current Sense
 - Reverse Discharge Protection
- High Accuracy Preset Voltage Regulation: $\pm 0.75\%$
- Four Voltage Regulation Options:
 - 4.20V, 4.35V, 4.40V, 4.50V
- Programmable Charge Current: 15 mA to 500 mA
- Selectable Preconditioning:
 - 10%, 20%, 40%, or Disable
- Selectable End-of-Charge Control:
 - 5%, 7.5%, 10%, or 20%
- Charge Status Output
 - Tri-State Output - MCP73831
 - Open-Drain Output - MCP73832
- Automatic Power-Down
- Thermal Regulation
- Temperature Range: -40°C to $+85^{\circ}\text{C}$
- Packaging:
 - 8-Lead, 2 mm x 3 mm DFN
 - 5-Lead, SOT-23

Applications

- Lithium-Ion/Lithium-Polymer Battery Chargers
- Personal Data Assistants
- Cellular Telephones
- Digital Cameras
- MP3 Players
- Bluetooth Headsets
- USB Chargers

Typical Application

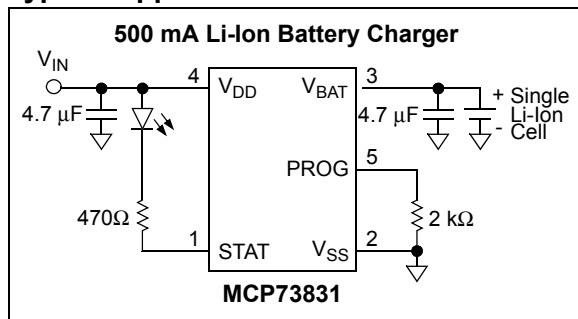

Description:

The MCP73831/2 devices are highly advanced linear charge management controllers for use in space-limited, cost-sensitive applications. The MCP73831/2 are available in an 8-Lead, 2 mm x 3 mm DFN package or a 5-Lead, SOT-23 package. Along with their small physical size, the low number of external components required make the MCP73831/2 ideally suited for portable applications. For applications charging from a USB port, the MCP73831/2 adhere to all the specifications governing the USB power bus.

The MCP73831/2 employ a constant-current/constant-voltage charge algorithm with selectable preconditioning and charge termination. The constant regulation is fixed with four available options: 4.20V, 4.35V, 4.40V or 4.50V, to accommodate new, emerging battery charging requirements. The constant current value is set with one external resistor. The MCP73831/2 devices limit the charge current based on die temperature during high power or high ambient conditions. This thermal regulation optimizes the charge cycle time while maintaining device reliability.

Several options are available for the preconditioning threshold, preconditioning current value, charge termination value and automatic recharge threshold. The preconditioning value and charge termination value are set as a ratio or percentage of the programmed constant current value. Preconditioning can be disabled. Refer to [Section 1.0 "Electrical Characteristics"](#) for available options and the [Product Identification System](#) for standard options.

The MCP73831/2 devices are fully specified over the ambient temperature range of -40°C to $+85^{\circ}\text{C}$.

Package Types

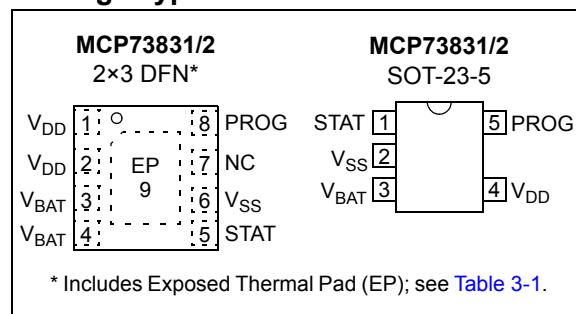

MCP73831/2

Functional Block Diagram

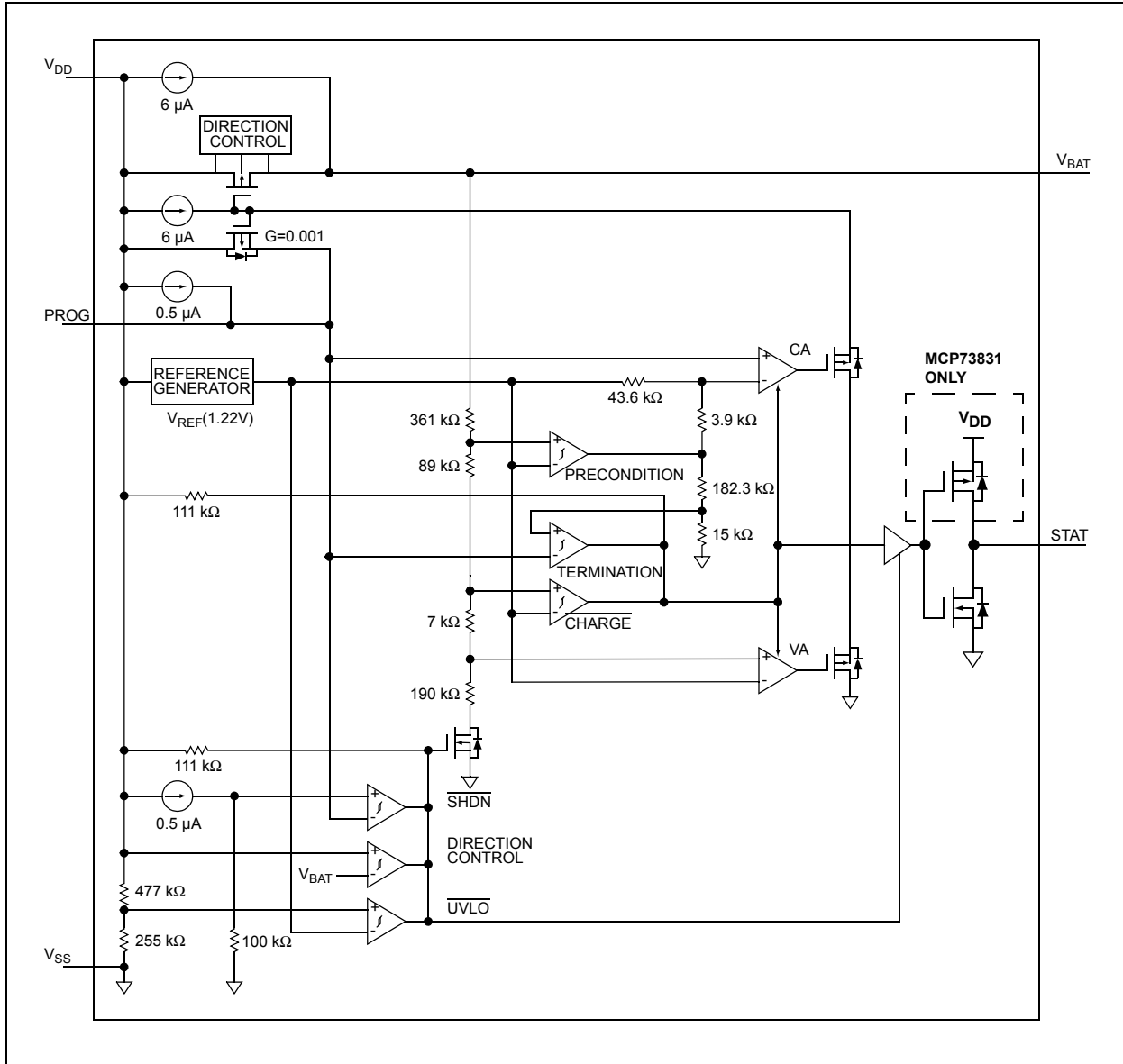

1.0 ELECTRICAL CHARACTERISTICS

Absolute Maximum Ratings†

V_{DD} 7.0V
 All Inputs and Outputs w.r.t. V_{SS} -0.3 to ($V_{DD}+0.3$)V
 Maximum Junction Temperature, T_J Internally Limited
 Storage temperature -65°C to +150°C
 ESD protection on all pins:
 Human Body Model (1.5 k Ω in Series with 100 pF) ≥ 4 kV
 Machine Model (200 pF, No Series Resistance) 400V

† **Notice:** Stresses above those listed under “Maximum Ratings” may cause permanent damage to the device. This is a stress rating only and functional operation of the device at those or any other conditions above those indicated in the operational listings of this specification is not implied. Exposure to maximum rating conditions for extended periods may affect device reliability.

DC CHARACTERISTICS

Electrical Specifications: Unless otherwise indicated, all limits apply for $V_{DD} = [V_{REG}(\text{typical}) + 0.3V]$ to 6V, $T_A = -40^\circ\text{C}$ to $+85^\circ\text{C}$. Typical values are at $+25^\circ\text{C}$, $V_{DD} = [V_{REG}(\text{typical}) + 1.0V]$

Parameters	Sym.	Min.	Typ.	Max.	Units	Conditions
Supply Input						
Supply Voltage	V_{DD}	3.75	—	6	V	
Supply Current	I_{SS}	—	510	1500	μA	Charging
		—	53	200	μA	Charge Complete, No Battery
		—	25	50	μA	PROG Floating
		—	1	5	μA	$V_{DD} \leq (V_{BAT} - 50 \text{ mV})$
		—	0.1	2	μA	$V_{DD} < V_{STOP}$
UVLO Start Threshold	V_{START}	3.3	3.45	3.6	V	V_{DD} Low-to-High
UVLO Stop Threshold	V_{STOP}	3.2	3.38	3.5	V	V_{DD} High-to-Low
UVLO Hysteresis	V_{HYS}	—	70	—	mV	
Voltage Regulation (Constant-Voltage Mode)						
Regulated Output Voltage	V_{REG}	4.168	4.20	4.232	V	PIC18FXXXX-2
		4.317	4.35	4.383	V	PIC18FXXXX-3
		4.367	4.40	4.433	V	PIC18FXXXX-4
		4.466	4.50	4.534	V	PIC18FXXXX-5
Line Regulation	$ \frac{\Delta V_{BAT}}{V_{BAT}} / \frac{\Delta V_{DD}}{V_{DD}} $	—	0.09	0.30	%/V	$V_{DD} = [V_{REG}(\text{typical})+1V]$ to 6V, $I_{OUT} = 10 \text{ mA}$
Load Regulation	$ \frac{\Delta V_{BAT}}{V_{BAT}} $	—	0.05	0.30	%	$I_{OUT} = 10 \text{ mA}$ to 50 mA $V_{DD} = [V_{REG}(\text{typical})+1V]$
Supply Ripple Attenuation	PSRR	—	52	—	dB	$I_{OUT} = 10 \text{ mA}$, 10Hz to 1 kHz
		—	47	—	dB	$I_{OUT} = 10 \text{ mA}$, 10Hz to 10 kHz
		—	22	—	dB	$I_{OUT} = 10 \text{ mA}$, 10Hz to 1 MHz
Current Regulation (Fast Charge Constant-Current Mode)						
Fast Charge Current Regulation	I_{REG}	90	100	110	mA	PROG = 10 k Ω
		450	505	550	mA	PROG = 2.0 k Ω , Note 1
		12.5	14.5	16.5	mA	PROG = 67 k Ω

Note 1: Not production tested. Ensured by design.

MCP73831/2

DC CHARACTERISTICS (CONTINUED)

Electrical Specifications: Unless otherwise indicated, all limits apply for $V_{DD} = [V_{REG}(\text{typical}) + 0.3V]$ to 6V, $T_A = -40^\circ\text{C}$ to $+85^\circ\text{C}$. Typical values are at $+25^\circ\text{C}$, $V_{DD} = [V_{REG}(\text{typical}) + 1.0V]$

Parameters	Sym.	Min.	Typ.	Max.	Units	Conditions
Preconditioning Current Regulation (Trickle Charge Constant-Current Mode)						
Precondition Current Ratio	I_{PREG} / I_{REG}	7.5	10	12.5	%	PROG = 2.0 k Ω to 10 k Ω
		15	20	25	%	PROG = 2.0 k Ω to 10 k Ω
		30	40	50	%	PROG = 2.0 k Ω to 10 k Ω
		—	100	—	%	No Preconditioning
						$T_A = -5^\circ\text{C}$ to $+55^\circ\text{C}$
Precondition Voltage Threshold Ratio	V_{PTH} / V_{REG}	64	66.5	69	%	V_{BAT} Low-to-High
		69	71.5	74	%	V_{BAT} Low-to-High
Precondition Hysteresis	V_{PHYS}	—	110	—	mV	V_{BAT} High-to-Low
Charge Termination						
Charge Termination Current Ratio	I_{TERM} / I_{REG}	3.75	5	6.25	%	PROG = 2.0 k Ω to 10 k Ω
		5.6	7.5	9.4	%	PROG = 2.0 k Ω to 10 k Ω
		8.5	10	11.5	%	PROG = 2.0 k Ω to 10 k Ω
		15	20	25	%	PROG = 2.0 k Ω to 10 k Ω
Automatic Recharge						
Recharge Voltage Threshold Ratio	V_{RTH} / V_{REG}	91.5	94.0	96.5	%	V_{BAT} High-to-Low
		94	96.5	99	%	V_{BAT} High-to-Low
Pass Transistor ON-Resistance						
ON-Resistance	R_{DSON}	—	350	—	m Ω	$V_{DD} = 3.75V$, $T_J = 105^\circ\text{C}$
Battery Detection						
Battery Detection Current	I_{BAT_DET}	—	6	—	μA	V_{BAT} Source Current
No-Battery-Present Threshold	V_{NO_BAT}	—	$V_{REG} + 100\text{ mV}$	—	V	V_{BAT} Voltage $\geq V_{NO_BAT}$ for No Battery condition
No-Battery-Present Impedance	Z_{NO_BAT}	2	—	—	M Ω	V_{BAT} Impedance $\geq Z_{NO_BAT}$ for No Battery condition, Note 1
Battery Discharge Current						
Output Reverse Leakage Current	$I_{DISCHARGE}$	—	0.15	2	μA	PROG Floating
		—	0.25	2	μA	V_{DD} Floating
		—	0.15	2	μA	$V_{DD} < V_{STOP}$
		—	-5.5	-15	μA	Charge Complete
Status Indicator – STAT						
Sink Current	I_{SINK}	—	—	25	mA	
Low Output Voltage	V_{OL}	—	0.4	1	V	$I_{SINK} = 4\text{ mA}$
Source Current	I_{SOURCE}	—	—	35	mA	
High Output Voltage	V_{OH}	—	$V_{DD} - 0.4$	$V_{DD} - 1$	V	$I_{SOURCE} = 4\text{ mA}$ (MCP73831)
Input Leakage Current	I_{LK}	—	0.03	1	μA	High-Impedance
PROG Input						
Charge Impedance Range	R_{PROG}	2	—	67	k Ω	
Minimum Shutdown Impedance	R_{PROG}	70	—	200	k Ω	
Automatic Power Down						
Automatic Power Down Entry Threshold	$V_{PDENTER}$	$V_{DD} < (V_{BAT} + 20\text{ mV})$	$V_{DD} < (V_{BAT} + 50\text{ mV})$	—		$3.5V \leq V_{BAT} \leq V_{REG}$ V_{DD} Falling

Note 1: Not production tested. Ensured by design.

DC CHARACTERISTICS (CONTINUED)

Electrical Specifications: Unless otherwise indicated, all limits apply for $V_{DD} = [V_{REG}(\text{typical}) + 0.3V]$ to 6V, $T_A = -40^\circ\text{C}$ to $+85^\circ\text{C}$. Typical values are at $+25^\circ\text{C}$, $V_{DD} = [V_{REG}(\text{typical}) + 1.0V]$

Parameters	Sym.	Min.	Typ.	Max.	Units	Conditions
Automatic Power Down Exit Threshold	V_{PDEXIT}	—	$V_{DD} < (V_{BAT} + 150\text{ mV})$	$V_{DD} < (V_{BAT} + 200\text{ mV})$		$3.5V \leq V_{BAT} \leq V_{REG}$ V_{DD} Rising
Thermal Shutdown						
Die Temperature	T_{SD}	—	150	—	$^\circ\text{C}$	
Die Temperature Hysteresis	T_{SDHYS}	—	10	—	$^\circ\text{C}$	

Note 1: Not production tested. Ensured by design.

AC CHARACTERISTICS

Electrical Specifications: Unless otherwise indicated, all limits apply for $V_{DD} = [V_{REG}(\text{typical}) + 0.3V]$ to 12V, $T_A = -40^\circ\text{C}$ to $+85^\circ\text{C}$. Typical values are at $+25^\circ\text{C}$, $V_{DD} = [V_{REG}(\text{typical}) + 1.0V]$

Parameters	Sym.	Min.	Typ.	Max.	Units	Conditions
UVLO Start Delay	t_{START}	—	—	5	ms	V_{DD} Low-to-High
Constant-Current Regulation						
Transition Time Out of Preconditioning	t_{DELAY}	—	—	1	ms	$V_{BAT} < V_{PTH}$ to $V_{BAT} > V_{PTH}$
Current Rise Time Out of Preconditioning	t_{RISE}	—	—	1	ms	I_{OUT} Rising to 90% of I_{REG}
Termination Comparator Filter	t_{TERM}	0.4	1.3	3.2	ms	Average I_{OUT} Falling
Charge Comparator Filter	t_{CHARGE}	0.4	1.3	3.2	ms	Average V_{BAT}
Status Indicator						
Status Output turn-off	t_{OFF}	—	—	200	μs	$I_{SINK} = 1\text{ mA}$ to 0 mA
Status Output turn-on	t_{ON}	—	—	200	μs	$I_{SINK} = 0\text{ mA}$ to 1 mA

TEMPERATURE SPECIFICATIONS

Electrical Specifications: Unless otherwise indicated, all limits apply for $V_{DD} = [V_{REG}(\text{typical}) + 0.3V]$ to 12V. Typical values are at $+25^\circ\text{C}$, $V_{DD} = [V_{REG}(\text{typical}) + 1.0V]$

Parameters	Sym.	Min.	Typ.	Max.	Units	Conditions
Temperature Ranges						
Specified Temperature Range	T_A	-40	—	+85	$^\circ\text{C}$	
Operating Temperature Range	T_J	-40	—	+125	$^\circ\text{C}$	
Storage Temperature Range	T_A	-65	—	+150	$^\circ\text{C}$	
Thermal Package Resistances						
5-Lead, SOT-23	θ_{JA}	—	230	—	$^\circ\text{C/W}$	4-Layer JC51-7 Standard Board, Natural Convection (Note 2)
8-Lead, 2 mm x 3 mm, DFN	θ_{JA}	—	76	—	$^\circ\text{C/W}$	4-Layer JC51-7 Standard Board, Natural Convection (Note 1)

Note 1: This represents the minimum copper condition on the PCB (Printed Circuit Board).

2: With large copper area on the PCB, the SOT-23-5 thermal resistance (θ_{JA}) can reach a typical value of 130°C/W or better.

MCP73831/2

NOTES:

2.0 TYPICAL PERFORMANCE CURVES

Note: The graphs and tables provided following this note are a statistical summary based on a limited number of samples and are provided for informational purposes only. The performance characteristics listed herein are not tested or guaranteed. In some graphs or tables, the data presented may be outside the specified operating range (e.g., outside specified power supply range) and therefore outside the warranted range.

Note: Unless otherwise indicated, $V_{DD} = [V_{REG}(\text{typical}) + 1V]$, $I_{OUT} = 10 \text{ mA}$ and $T_A = +25^\circ\text{C}$, Constant-Voltage mode.

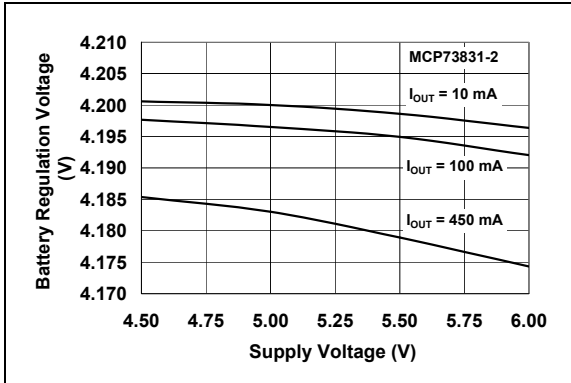

FIGURE 2-1: Battery Regulation Voltage (V_{BAT}) vs. Supply Voltage (V_{DD}).

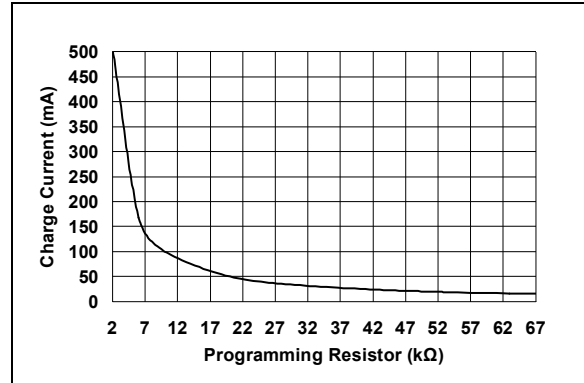

FIGURE 2-4: Charge Current (I_{OUT}) vs. Programming Resistor (R_{PROG}).

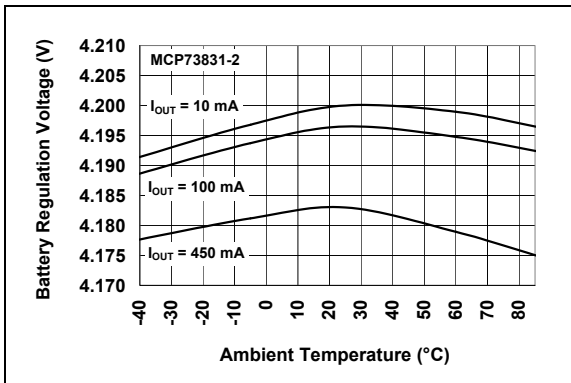

FIGURE 2-2: Battery Regulation Voltage (V_{BAT}) vs. Ambient Temperature (T_A).

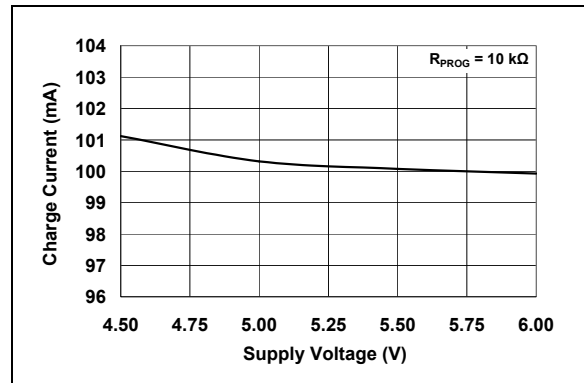

FIGURE 2-5: Charge Current (I_{OUT}) vs. Supply Voltage (V_{DD}).

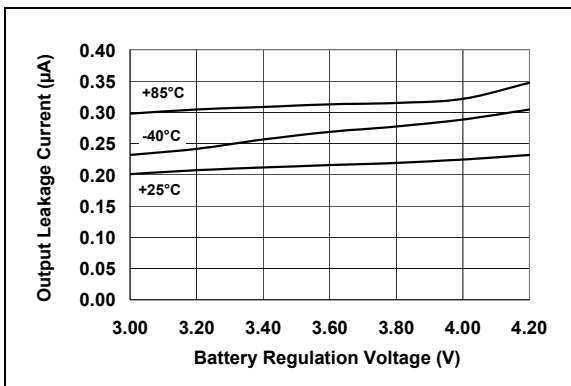

FIGURE 2-3: Output Leakage Current ($I_{DISCHARGE}$) vs. Battery Regulation Voltage (V_{BAT}).

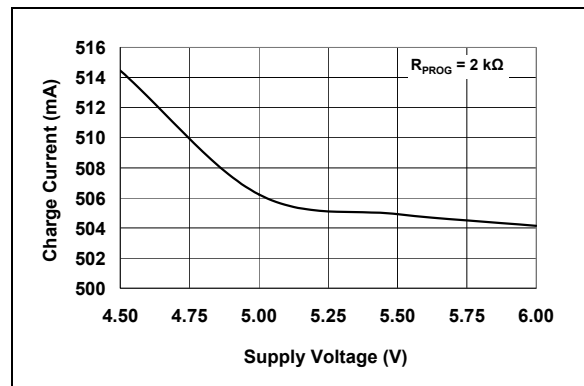

FIGURE 2-6: Charge Current (I_{OUT}) vs. Supply Voltage (V_{DD}).

MCP73831/2

TYPICAL PERFORMANCE CURVES (CONTINUED)

Note: Unless otherwise indicated, $V_{DD} = [V_{REG}(\text{typical}) + 1V]$, $I_{OUT} = 10 \text{ mA}$ and $T_A = +25^\circ\text{C}$, Constant-Voltage mode.

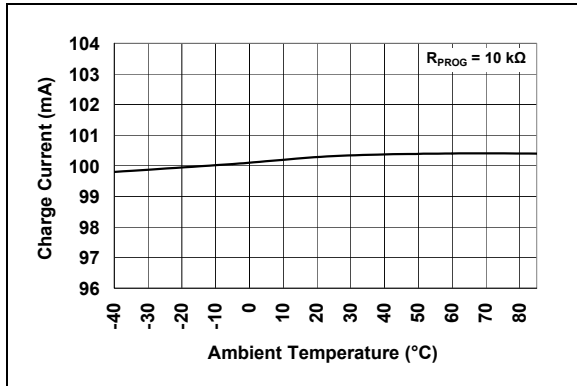

FIGURE 2-7: Charge Current (I_{OUT}) vs. Ambient Temperature (T_A).

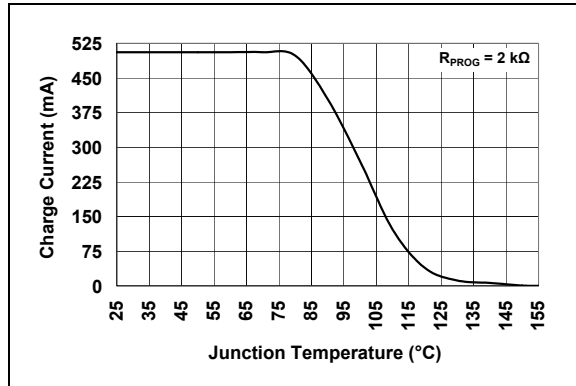

FIGURE 2-10: Charge Current (I_{OUT}) vs. Junction Temperature (T_J).

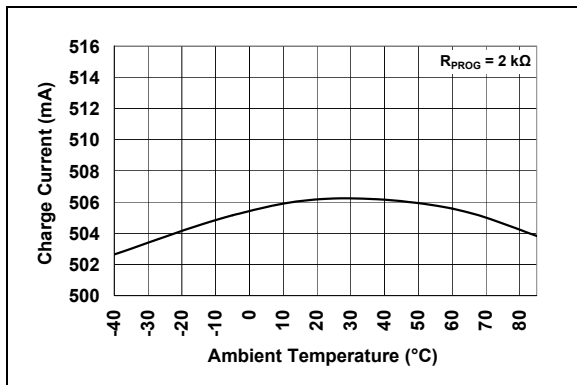

FIGURE 2-8: Charge Current (I_{OUT}) vs. Ambient Temperature (T_A).

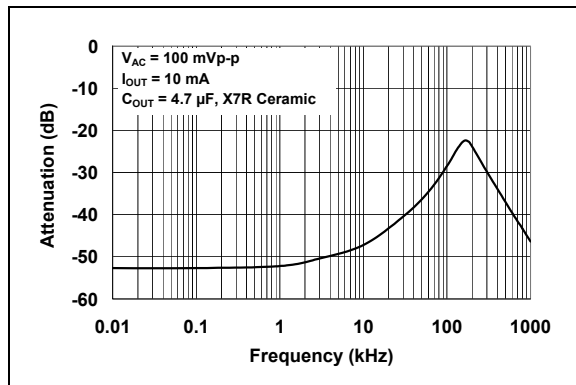

FIGURE 2-11: Power Supply Ripple Rejection (PSRR).

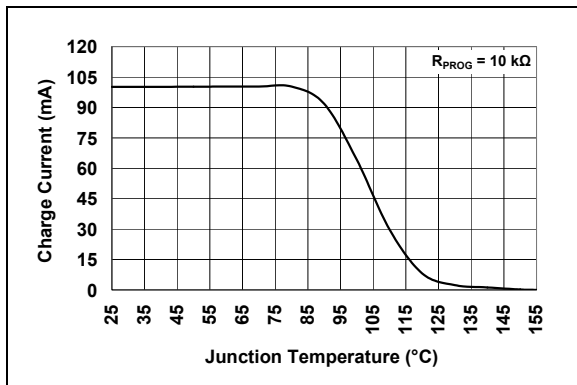

FIGURE 2-9: Charge Current (I_{OUT}) vs. Junction Temperature (T_J).

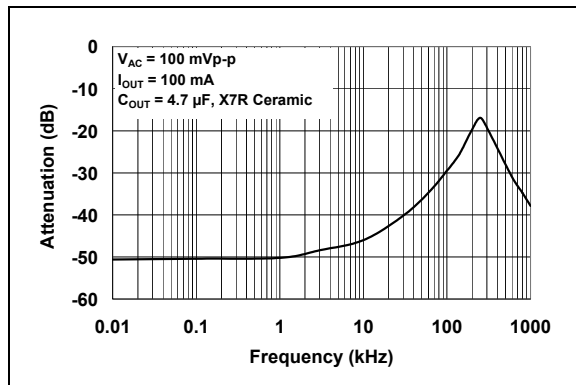

FIGURE 2-12: Power Supply Ripple Rejection (PSRR).

TYPICAL PERFORMANCE CURVES (CONTINUED)

Note: Unless otherwise indicated, $V_{DD} = [V_{REG}(typical) + 1V]$, $I_{OUT} = 10\text{ mA}$ and $T_A = +25^\circ\text{C}$, Constant-Voltage mode.

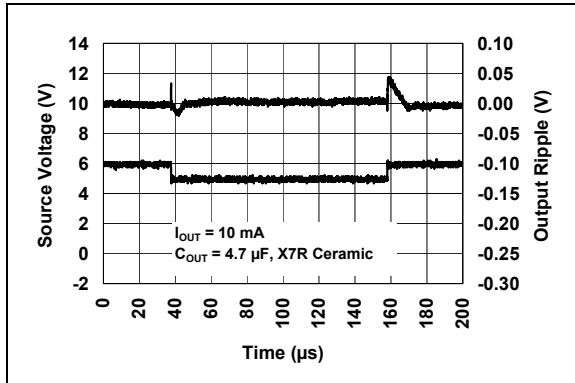

FIGURE 2-13: Line Transient Response.

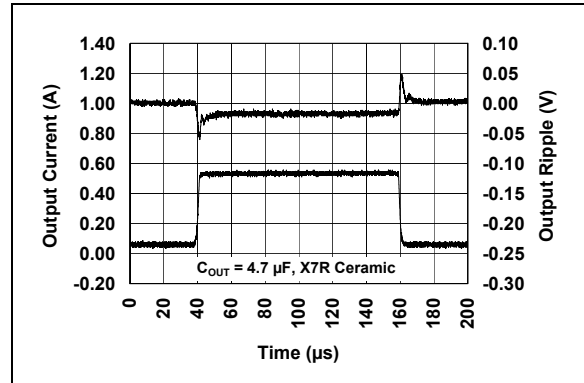

FIGURE 2-16: Load Transient Response.

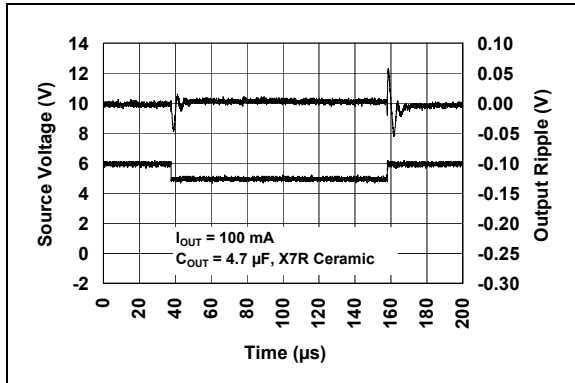

FIGURE 2-14: Line Transient Response.

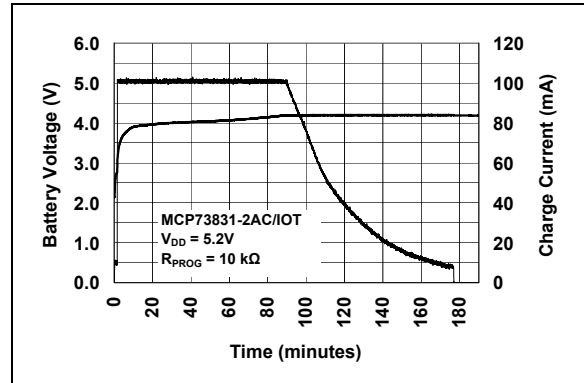

FIGURE 2-17: Complete Charge Cycle (180 mAh Li-Ion Battery).

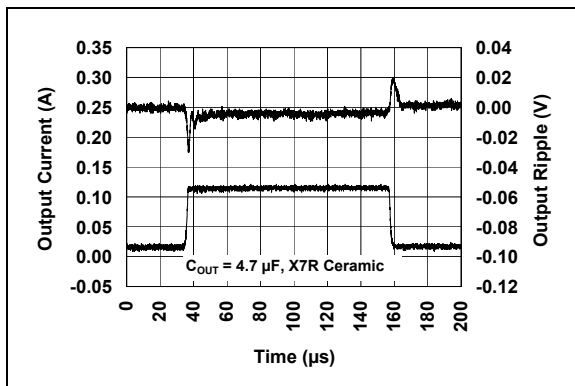

FIGURE 2-15: Load Transient Response.

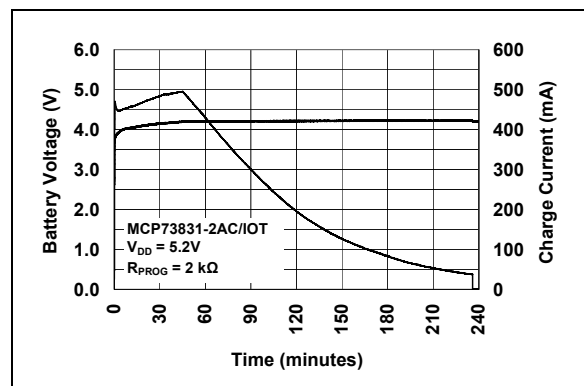

FIGURE 2-18: Complete Charge Cycle (1000 mAh Li-Ion Battery).

MCP73831/2

NOTES:

3.0 PIN DESCRIPTION

The descriptions of the pins are listed in [Table 3-1](#).

TABLE 3-1: PIN FUNCTION TABLES

Pin No.		Symbol	Function
DFN	SOT-23-5		
1	4	V_{DD}	Battery Management Input Supply
2	—	V_{DD}	Battery Management Input Supply
3	3	V_{BAT}	Battery Charge Control Output
4	—	V_{BAT}	Battery Charge Control Output
5	1	STAT	Charge Status Output
6	2	V_{SS}	Battery Management 0V Reference
7	—	NC	No Connection
8	5	PROG	Current Regulation Set and Charge Control Enable
9	—	EP	Exposed Thermal Pad (EP); must be connected to V_{SS} .

3.1 Battery Management Input Supply (V_{DD})

A supply voltage of [V_{REG} (typical) + 0.3V] to 6V is recommended. Bypass to V_{SS} with a minimum of 4.7 μ F.

3.2 Battery Charge Control Output (V_{BAT})

Connect to positive terminal of battery. Drain terminal of internal P-channel MOSFET pass transistor. Bypass to V_{SS} with a minimum of 4.7 μ F to ensure loop stability when the battery is disconnected.

3.3 Charge Status Output (STAT)

STAT is an output for connection to an LED for charge status indication. Alternatively, a pull-up resistor can be applied for interfacing to a host microcontroller.

STAT is a tri-state logic output on the MCP73831 and an open-drain output on the MCP73832.

3.4 Battery Management 0V Reference (V_{SS})

Connect to negative terminal of battery and input supply.

3.5 Current Regulation Set (PROG)

Preconditioning, fast charge and termination currents are scaled by placing a resistor from PROG to V_{SS} .

The charge management controller can be disabled by allowing the PROG input to float.

3.6 Exposed Thermal Pad (EP)

An internal electrical connection exists between the Exposed Thermal Pad (EP) and the V_{SS} pin. They must be connected to the same potential on the Printed Circuit Board (PCB).

For better thermal performance, it is recommended to add vias from the land area of EP to a copper layer on the other side of the PCB.

MCP73831/2

NOTES:

4.0 DEVICE OVERVIEW

The MCP73831/2 are highly advanced linear charge management controllers. [Figure 4-1](#) depicts the operational flow algorithm from charge initiation to completion and automatic recharge.

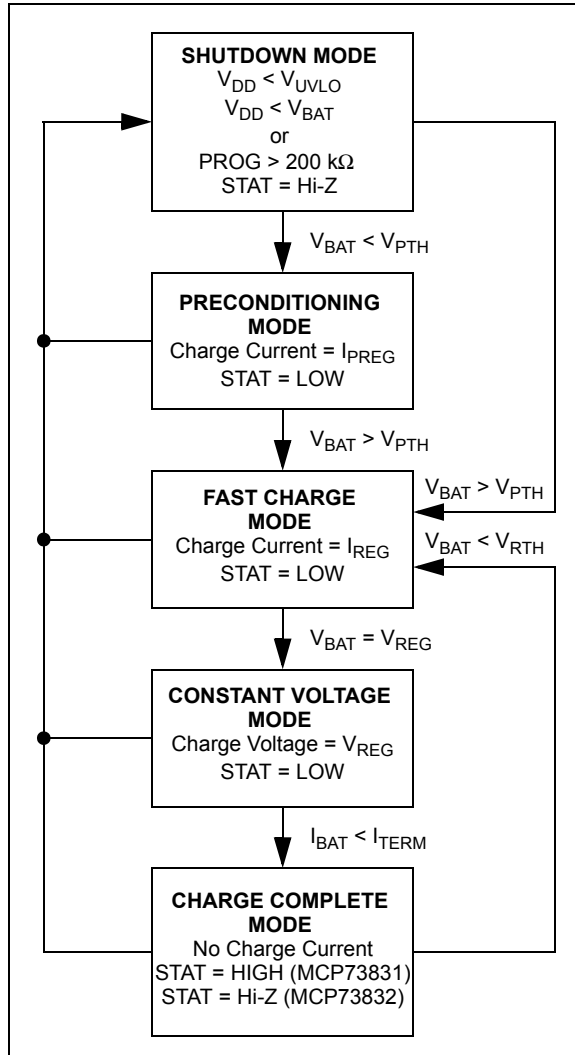

FIGURE 4-1: Flowchart.

4.1 Undervoltage Lockout (UVLO)

An internal UVLO circuit monitors the input voltage and keeps the charger in Shutdown mode until the input supply rises above the UVLO threshold. The UVLO circuitry has a built in hysteresis of 100 mV.

In the event a battery is present when the input power is applied, the input supply must rise to a level 150 mV above the battery voltage before the MCP73831/2 become operational.

The UVLO circuit places the device in Shutdown mode if the input supply falls to within +50 mV of the battery voltage. Again, the input supply must rise to a level 150 mV above the battery voltage before the MCP73831/2 become operational.

The UVLO circuit is always active. Whenever the input supply is below the UVLO threshold or within +50 mV of the voltage at the V_{BAT} pin, the MCP73831/2 are placed in Shutdown mode.

During any UVLO condition, the battery reverse discharge current is less than 2 μ A.

4.2 Battery Detection

A 6 μ A (typical) current is sourced by the V_{BAT} pin to determine if a battery is present or not. If the voltage at V_{BAT} rises to $V_{REG} + 100$ mV (typical), the device assumes that a battery is not present. If the voltage stays below $V_{REG} + 100$ mV (typical), the device assumes that a battery is detected. In order to correctly detect a battery insertion, the impedance seen by the V_{BAT} pin before the battery is connected must be greater than 2 M Ω .

4.3 Charge Qualification

For a charge cycle to begin, all UVLO conditions must be met and a battery or output load must be present. A charge current programming resistor must be connected from PROG to V_{SS} . If the PROG pin is open or floating, the MCP73831/2 are disabled and the battery reverse discharge current is less than 2 μ A. In this manner, the PROG pin acts as a charge enable and can be used as a manual shutdown.

4.4 Preconditioning

If the voltage at the V_{BAT} pin is less than the preconditioning threshold, the MCP73831/2 enter a preconditioning or Trickle Charge mode. The preconditioning threshold is factory set. Refer to [Section 1.0 "Electrical Characteristics"](#) for preconditioning threshold options and the [Product Identification System](#) for standard options.

In this mode, the MCP73831/2 supply a percentage of the charge current (established with the value of the resistor connected to the PROG pin) to the battery. The percentage or ratio of the current is factory set. Refer to [Section 1.0 "Electrical Characteristics"](#) for preconditioning current options and the [Product Identification System](#) for standard options.

When the voltage at the V_{BAT} pin rises above the preconditioning threshold, the MCP73831/2 enter the Constant-Current or Fast Charge mode.

MCP73831/2

4.5 Fast Charge Constant-Current Mode

During the Constant-Current mode, the programmed charge current is supplied to the battery or load. The charge current is established using a single resistor from PROG to V_{SS} . Constant-Current mode is maintained until the voltage at the V_{BAT} pin reaches the regulation voltage, V_{REG} .

4.6 Constant-Voltage Mode

When the voltage at the V_{BAT} pin reaches the regulation voltage, V_{REG} , constant voltage regulation begins. The regulation voltage is factory set to 4.2V, 4.35V, 4.40V or 4.50V with a tolerance of $\pm 0.75\%$.

4.7 Charge Termination

The charge cycle is terminated when, during Constant-Voltage mode, the average charge current diminishes below a percentage of the programmed charge current (established with the value of the resistor connected to the PROG pin). A 1 ms filter time on the termination comparator ensures that transient load conditions do not result in premature charge cycle termination. The percentage or ratio of the current is factory set. Refer to [Section 1.0 “Electrical Characteristics”](#) for charge termination current options and the [Product Identification System](#) for standard options.

The charge current is latched off and the MCP73831/2 enter a Charge Complete mode.

4.8 Automatic Recharge

The MCP73831/2 continuously monitor the voltage at the V_{BAT} pin in the Charge Complete mode. If the voltage drops below the recharge threshold, another charge cycle begins and current is once again supplied to the battery or load. The recharge threshold is factory set. Refer to [Section 1.0 “Electrical Characteristics”](#) for recharge threshold options and the [Product Identification System](#) for standard options.

4.9 Thermal Regulation

The MCP73831/2 limit the charge current based on the die temperature. The thermal regulation optimizes the charge cycle time while maintaining device reliability. [Figure 4-2](#) depicts the thermal regulation for the MCP73831/2.

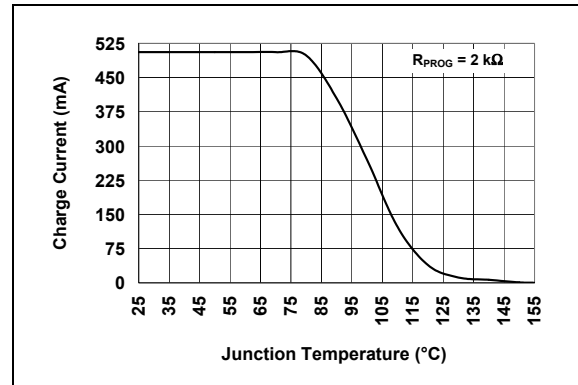

FIGURE 4-2: Thermal Regulation.

4.10 Thermal Shutdown

The MCP73831/2 suspend charge if the die temperature exceeds 150°C. Charging will resume when the die temperature has cooled by approximately 10°C.

5.0 DETAILED DESCRIPTION

5.1 Analog Circuitry

5.1.1 BATTERY MANAGEMENT INPUT SUPPLY (V_{DD})

The V_{DD} pin is the input supply pin for the MCP73831/2 devices. The MCP73831/2 automatically enter a Power-Down mode if the voltage on the V_{DD} input falls below the UVLO voltage (V_{STOP}). This feature prevents draining the battery pack when the V_{DD} supply is not present.

5.1.2 CURRENT REGULATION SET (PROG)

Fast charge current regulation can be scaled by placing a programming resistor (R_{PROG}) from the PROG input to V_{SS} . The program resistor and the charge current are calculated using the following equation:

$$I_{REG} = \frac{1000V}{R_{PROG}}$$

Where:

$$\begin{aligned} R_{PROG} &= \text{kOhms} \\ I_{REG} &= \text{milliampere} \end{aligned}$$

The preconditioning trickle charge current and the charge termination current are ratiometric to the fast charge current based on the selected device options.

5.1.3 BATTERY CHARGE CONTROL OUTPUT (V_{BAT})

The battery charge control output is the drain terminal of an internal P-channel MOSFET. The MCP73831/2 provide constant current and voltage regulation to the battery pack by controlling this MOSFET in the linear region. The battery charge control output should be connected to the positive terminal of the battery pack.

5.2 Digital Circuitry

5.2.1 STATUS INDICATOR (STAT)

The charge status output of the MCP73831 has three different states: High (H), Low (L), and High-Impedance (Hi-Z). The charge status output of the MCP73832 is open-drain. It has two different states: Low (L) and High-Impedance (Hi-Z). The charge status output can be used to illuminate one, two or tri-color LEDs. Optionally, the charge status output can be used as an interface to a host microcontroller.

Table 5-1 summarizes the state of the status output during a charge cycle.

TABLE 5-1: STATUS OUTPUT

Charge Cycle State	STAT1	
	MCP73831	MCP73832
Shutdown	Hi-Z	Hi-Z
No Battery Present	Hi-Z	Hi-Z
Preconditioning	L	L
Constant-Current Fast Charge	L	L
Constant Voltage	L	L
Charge Complete – Standby	H	Hi-Z

5.2.2 DEVICE DISABLE (PROG)

The current regulation set input pin (PROG) can be used to terminate a charge at any time during the charge cycle, as well as to initiate a charge cycle or initiate a recharge cycle.

Placing a programming resistor from the PROG input to V_{SS} enables the device. Allowing the PROG input to float or by applying a logic-high input signal, disables the device and terminates a charge cycle. When disabled, the device's supply current is reduced to 25 μA , typically.

MCP73831/2

NOTES:

6.0 APPLICATIONS

The MCP73831/2 are designed to operate in conjunction with a host microcontroller or in a stand-alone application. The MCP73831/2 provide the preferred charge algorithm for Lithium-Ion and Lithium-Polymer cells. The algorithm uses a constant current

followed by a constant voltage charging method. [Figure 6-1](#) depicts a typical stand-alone application circuit, while [Figure 6-2](#) and [Figure 6-3](#) depict the accompanying charge profile.

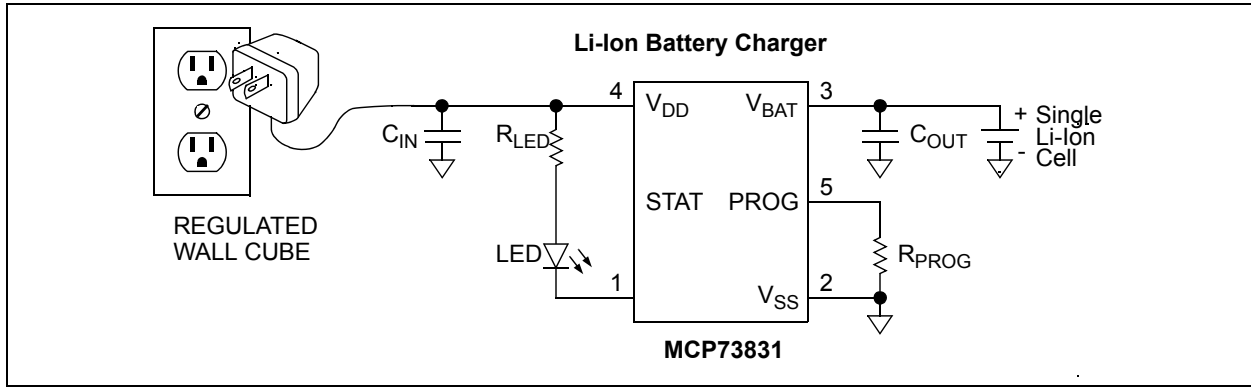

FIGURE 6-1: Typical Application Circuit.

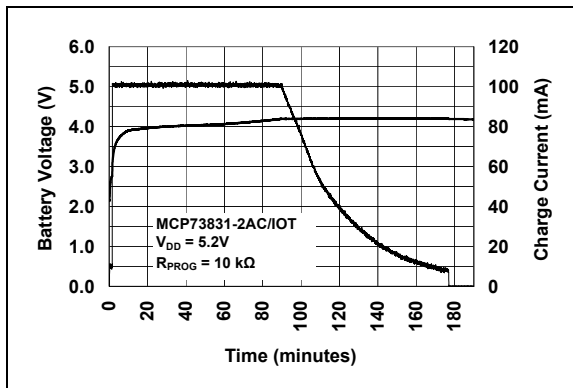

FIGURE 6-2: Typical Charge Profile (180 mAh Battery).

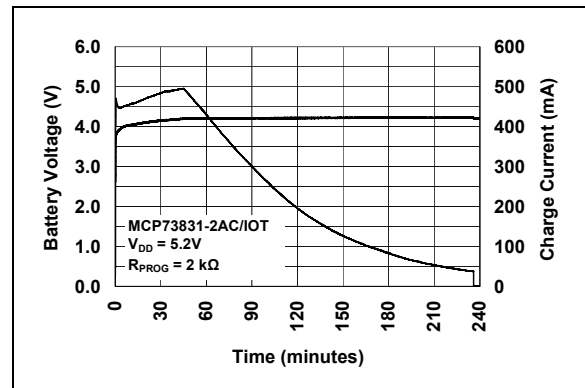

FIGURE 6-3: Typical Charge Profile in Thermal Regulation (1000 mAh Battery).

6.1 Application Circuit Design

Due to the low efficiency of linear charging, the most important factors are thermal design and cost, which are a direct function of the input voltage, output current and thermal impedance between the battery charger and the ambient cooling air. The worst-case situation is when the device has transitioned from the Preconditioning mode to the Constant-Current mode. In this situation, the battery charger has to dissipate the maximum power. A trade-off must be made between the charge current, cost and thermal requirements of the charger.

6.1.1 COMPONENT SELECTION

Selection of the external components in [Figure 6-1](#) is crucial to the integrity and reliability of the charging system. The following discussion is intended as a guide for the component selection process.

6.1.1.1 Current Programming Resistor (R_{PROG})

The preferred fast charge current for Lithium-Ion cells is at the 1C rate, with an absolute maximum current at the 2C rate. For example, a 500 mAh battery pack has a preferred fast charge current of 500 mA. Charging at this rate provides the shortest charge cycle times without degradation to the battery pack performance or life.

MCP73831/2

6.1.1.2 Thermal Considerations

The worst-case power dissipation in the battery charger occurs when the input voltage is at the maximum and the device has transitioned from the Preconditioning mode to the Constant-Current mode. In this case, the power dissipation is:

$$PowerDissipation = (V_{DDMAX} - V_{PTHMIN}) \times I_{REGMAX}$$

Where:

- V_{DDMAX} = the maximum input voltage
- I_{REGMAX} = the maximum fast charge current
- V_{PTHMIN} = the minimum transition threshold voltage

Power dissipation with a 5V, ±10% input voltage source is:

$$PowerDissipation = (5.5V - 2.7V) \times 550mA = 1.54W$$

This power dissipation with the battery charger in the SOT-23-5 package will cause thermal regulation to be entered as depicted in [Figure 6-3](#). Alternatively, the 2mm x 3mm DFN package could be utilized to reduce charge cycle times.

6.1.1.3 External Capacitors

The MCP73831/2 are stable with or without a battery load. In order to maintain good AC stability in the Constant-Voltage mode, a minimum capacitance of 4.7 μF is recommended to bypass the V_{BAT} pin to V_{SS} . This capacitance provides compensation when there is no battery load. In addition, the battery and interconnections appear inductive at high frequencies. These elements are in the control feedback loop during Constant-Voltage mode. Therefore, the bypass capacitance may be necessary to compensate for the inductive nature of the battery pack.

Virtually any good quality output filter capacitor can be used, independent of the capacitor's minimum Effective Series Resistance (ESR) value. The actual value of the capacitor (and its associated ESR) depends on the output load current. A 4.7 μF ceramic, tantalum or aluminum electrolytic capacitor at the output is usually sufficient to ensure stability for output currents up to a 500 mA.

6.1.1.4 Reverse-Blocking Protection

The MCP73831/2 provide protection from a faulted or shorted input. Without the protection, a faulted or shorted input would discharge the battery pack through the body diode of the internal pass transistor.

6.1.1.5 Charge Inhibit

The current regulation set input pin (PROG) can be used to terminate a charge at any time during the charge cycle, as well as to initiate a charge cycle or initiate a recharge cycle.

Placing a programming resistor from the PROG input to V_{SS} enables the device. Allowing the PROG input to float or by applying a logic-high input signal, disables the device and terminates a charge cycle. When disabled, the device's supply current is reduced to 25 μA, typically.

6.1.1.6 Charge Status Interface

A status output provides information on the state of charge. The output can be used to illuminate external LEDs or interface to a host microcontroller. Refer to [Table 5-1](#) for a summary of the state of the status output during a charge cycle.

6.2 PCB Layout Issues

For optimum voltage regulation, place the battery pack as close as possible to the device's V_{BAT} and V_{SS} pins. This is recommended to minimize voltage drops along the high current-carrying PCB traces.

If the PCB layout is used as a heatsink, adding many vias in the heatsink pad can help conduct more heat to the PCB backplane, thus reducing the maximum junction temperature. [Figure 6-4](#) and [Figure 6-5](#) depict a typical layout with PCB heatsinking.

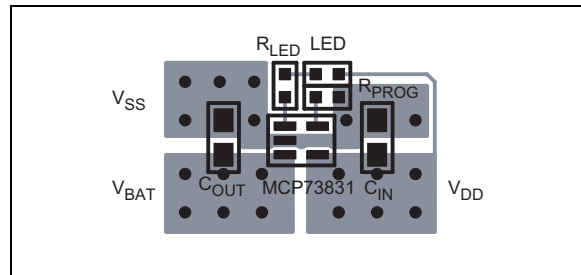

FIGURE 6-4: Typical Layout (Top).

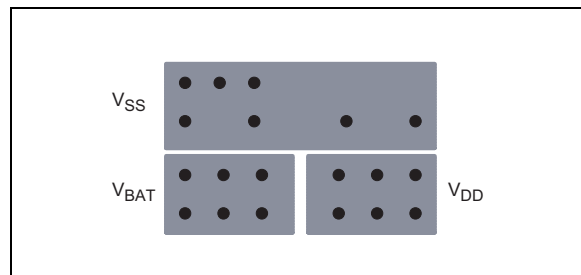
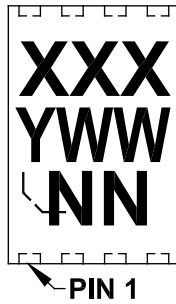

FIGURE 6-5: Typical Layout (Bottom).

7.0 PACKAGING INFORMATION

7.1 Package Marking Information

8-Lead DFN (2x3x0.9 mm)



Device	Code
MCP73831T-2ACI/MC	AAE
MCP73831T-2ATI/MC	AAF
MCP73831T-2DCI/MC	AAG
MCP73831T-3ACI/MC	AAH
MCP73831T-4ADI/MC	AAJ
MCP73831T-5ACI/MC	AAK
MCP73832T-2ACI/MC	AAL
MCP73832T-2ATI/MC	AAM
MCP73832T-2DCI/MC	AAP
MCP73832T-3ACI/MC	AAQ
MCP73832T-4ADI/MC	AAR
MCP73832T-5ACI/MC	AAS

Example

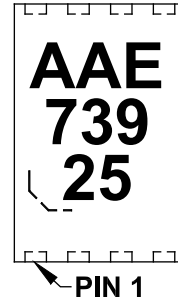

Note: Applies to 8-Lead DFN

5-Lead SOT-23

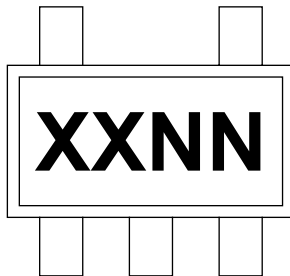

Device	Code
MCP73831T-2ACI/OT	KDNN
MCP73831T-2ATI/OT	KENN
MCP73831T-2DCI/OT	KFNN
MCP73831T-3ACI/OT	KGNN
MCP73831T-4ADI/OT	KHNN
MCP73831T-5ACI/OT	KJNN
MCP73832T-2ACI/OT	KKNN
MCP73832T-2ATI/OT	KLNN
MCP73832T-2DCI/OT	KMNN
MCP73832T-3ACI/OT	KPNN
MCP73832T-4ADI/OT	KQNN
MCP73832T-5ACI/OT	KRNN
MCP73832T-2DFI/OT	LUNN

Example

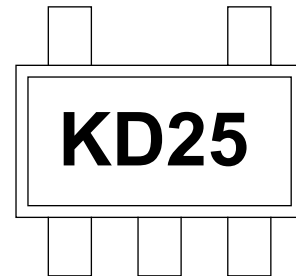

Note: Applies to 5-Lead SOT-23

Legend:	XX...X	Customer-specific information
	Y	Year code (last digit of calendar year)
	YY	Year code (last 2 digits of calendar year)
	WW	Week code (week of January 1 is week '01')
	NNN	Alphanumeric traceability code
	(e3)	Pb-free Compliant JEDEC designator for Matte Tin (Sn)
	*	This package is Pb-free. The Pb-free JEDEC designator (e3) can be found on the outer packaging for this package.

Note: In the event the full Microchip part number cannot be marked on one line, it will be carried over to the next line, thus limiting the number of available characters for customer-specific information.

MCP73831/2

8-Lead Plastic Dual Flat, No Lead Package (MC) – 2x3x0.9 mm Body [DFN]

Note: For the most current package drawings, please see the Microchip Packaging Specification located at <http://www.microchip.com/packaging>

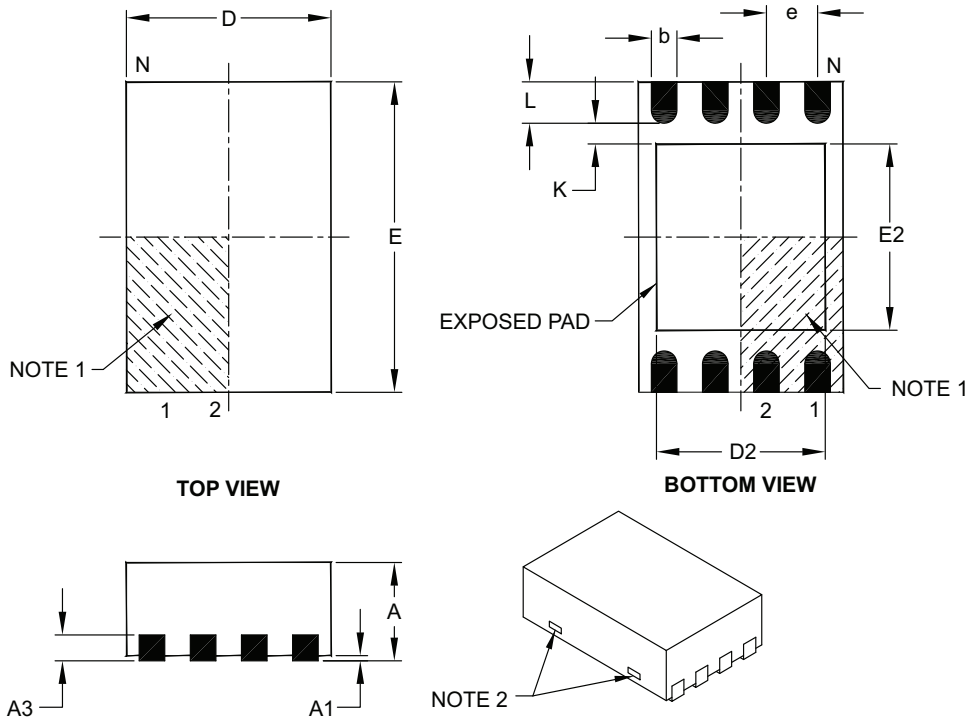

Dimension Limits	Units	MILLIMETERS		
		MIN	NOM	MAX
Number of Pins	N	8		
Pitch	e	0.50 BSC		
Overall Height	A	0.80	0.90	1.00
Standoff	A1	0.00	0.02	0.05
Contact Thickness	A3	0.20 REF		
Overall Length	D	2.00 BSC		
Overall Width	E	3.00 BSC		
Exposed Pad Length	D2	1.30	–	1.55
Exposed Pad Width	E2	1.50	–	1.75
Contact Width	b	0.20	0.25	0.30
Contact Length	L	0.30	0.40	0.50
Contact-to-Exposed Pad	K	0.20	–	–

Notes:

- Pin 1 visual index feature may vary, but must be located within the hatched area.
- Package may have one or more exposed tie bars at ends.
- Package is saw singulated.
- Dimensioning and tolerancing per ASME Y14.5M.

BSC: Basic Dimension. Theoretically exact value shown without tolerances.

REF: Reference Dimension, usually without tolerance, for information purposes only.

Microchip Technology Drawing C04-123C

8-Lead Plastic Dual Flat, No Lead Package (MC) - 2x3x0.9mm Body [DFN]

Note: For the most current package drawings, please see the Microchip Packaging Specification located at <http://www.microchip.com/packaging>

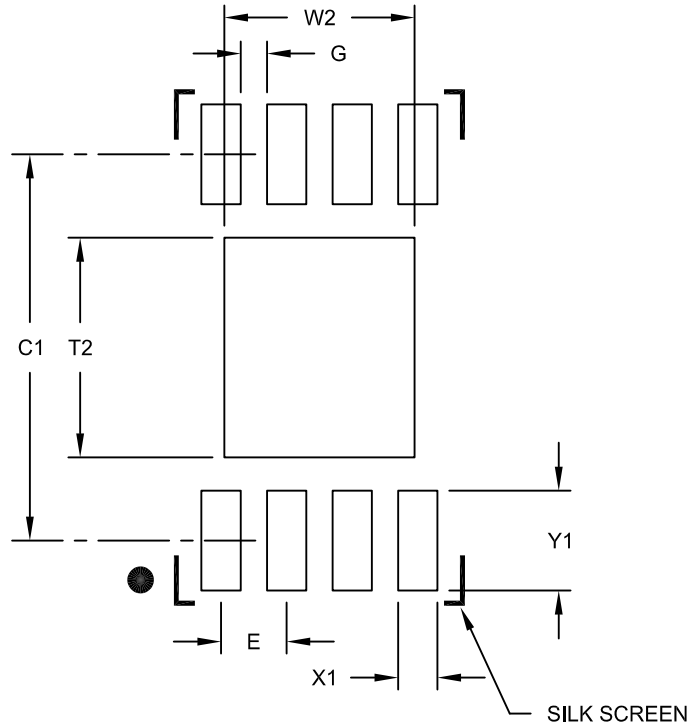

RECOMMENDED LAND PATTERN

Dimension Limits	Units	MILLIMETERS		
		MIN	NOM	MAX
Contact Pitch	E	0.50 BSC		
Optional Center Pad Width	W2			1.45
Optional Center Pad Length	T2			1.75
Contact Pad Spacing	C1		2.90	
Contact Pad Width (X8)	X1			0.30
Contact Pad Length (X8)	Y1			0.75
Distance Between Pads	G	0.20		

Notes:

1. Dimensioning and tolerancing per ASME Y14.5M

BSC: Basic Dimension. Theoretically exact value shown without tolerances.

Microchip Technology Drawing No. C04-2123B

MCP73831/2

5-Lead Plastic Small Outline Transistor (OT) [SOT-23]

Note: For the most current package drawings, please see the Microchip Packaging Specification located at <http://www.microchip.com/packaging>

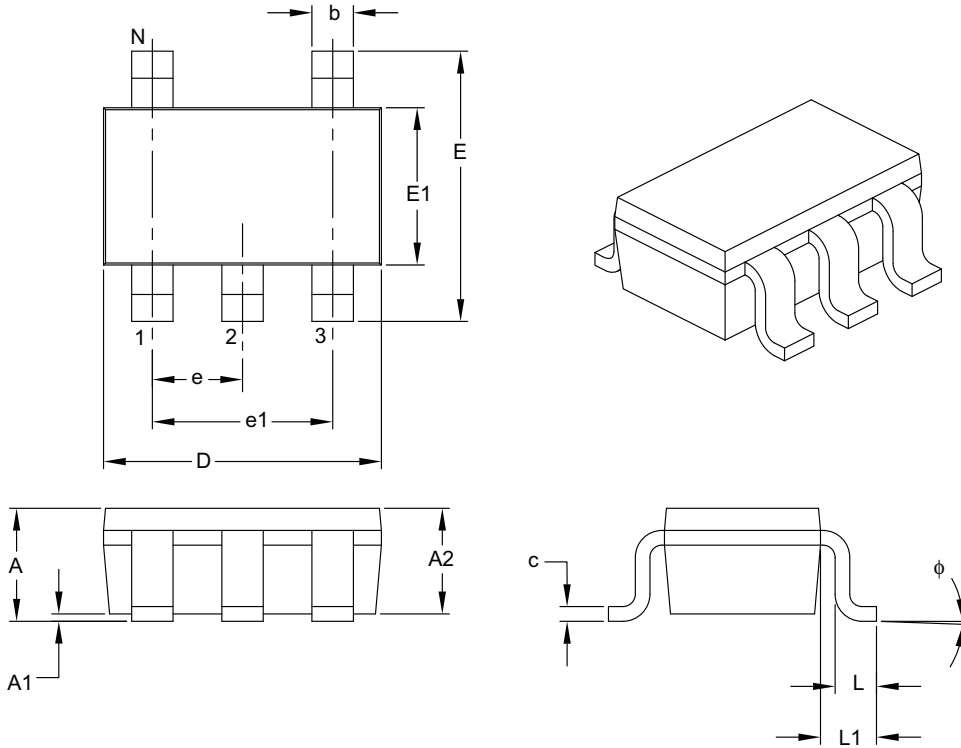

		Units	MILLIMETERS		
Dimension Limits			MIN	NOM	MAX
Number of Pins	N		5		
Lead Pitch	e		0.95 BSC		
Outside Lead Pitch	e1		1.90 BSC		
Overall Height	A		0.90	–	1.45
Molded Package Thickness	A2		0.89	–	1.30
Standoff	A1		0.00	–	0.15
Overall Width	E		2.20	–	3.20
Molded Package Width	E1		1.30	–	1.80
Overall Length	D		2.70	–	3.10
Foot Length	L		0.10	–	0.60
Footprint	L1		0.35	–	0.80
Foot Angle	ϕ		0°	–	30°
Lead Thickness	c		0.08	–	0.26
Lead Width	b		0.20	–	0.51

Notes:

- Dimensions D and E1 do not include mold flash or protrusions. Mold flash or protrusions shall not exceed 0.127 mm per side.
- Dimensioning and tolerancing per ASME Y14.5M.

BSC: Basic Dimension. Theoretically exact value shown without tolerances.

Microchip Technology Drawing C04-091B

5-Lead Plastic Small Outline Transistor (OT) [SOT-23]

Note: For the most current package drawings, please see the Microchip Packaging Specification located at <http://www.microchip.com/packaging>

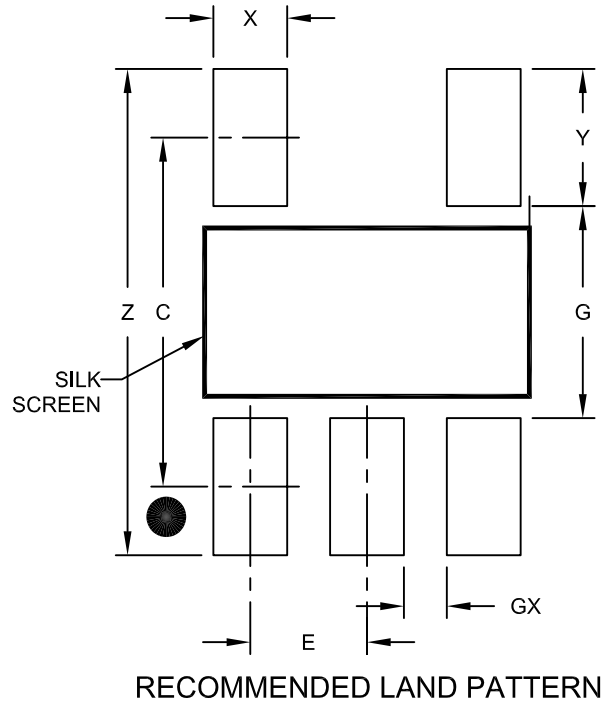

		MILLIMETERS		
Dimension Limits		MIN	NOM	MAX
Contact Pitch	E	0.95 BSC		
Contact Pad Spacing	C		2.80	
Contact Pad Width (X5)	X			0.60
Contact Pad Length (X5)	Y			1.10
Distance Between Pads	G	1.70		
Distance Between Pads	GX	0.35		
Overall Width	Z			3.90

Notes:

1. Dimensioning and tolerancing per ASME Y14.5M

BSC: Basic Dimension. Theoretically exact value shown without tolerances.

Microchip Technology Drawing No. C04-2091A

MCP73831/2

NOTES:

APPENDIX A: REVISION HISTORY

Revision F (June 2013)

The following is the list of modifications:

1. Updated the Functional Block Diagram.
2. Added the Battery Detection parameter and related information in the DC Characteristics table.
3. Added new section [Section 4.2 “Battery Detection”](#).
4. Minor grammatical and spelling corrections.

Revision E (September 2008)

The following is the list of modifications:

1. **Package Types:** Changed DFN pinout diagram.
2. [Section 1.0 “Electrical Characteristics”](#): Changed “Charge Impedance Range from 20 k Ω to 67 k Ω .”
3. [Section 1.0 “Electrical Characteristics”](#): Misc. Formatting changes.
4. [Section 2.0 “Typical Performance Curves”](#): Updated [Figure 2-4](#).
5. [Section 3.0 “Pin Description”](#): Added Exposed Pad pin to table and added [Section 3.6 “Exposed Thermal Pad \(EP\)”](#).
6. Updated [Appendix A: “Revision History”](#)
7. Added Land Pattern Package Outline Drawing for 2x3 DFN package.
8. Pagination fixes throughout document per MarCom Standards.

Revision D (April 2008)

The following is the list of modifications:

1. Changed Charge Termination Current Ratio to 8.5% minimum and 11.5% maximum.

Revision C (October 2007)

The following is the list of modifications:

1. Numerous edits throughout document.
2. Added note to Temperature Specifications table.
3. Updated [Figure 2-4](#).

Revision B (March 2006)

The following is the list of modifications:

1. Added MCP73832 through document.

Revision A (November 2005)

- Original Release of this Document.

MCP73831/2

NOTES:

PRODUCT IDENTIFICATION SYSTEM

To order or obtain information, e.g., on pricing or delivery, refer to the factory or the listed sales office.

<u>PART NO.</u>	<u>X</u>	<u>XX</u>	<u>X</u>	<u>/XX</u>																									
Device	V _{REG}	Options	Temperature Range	Package																									
<p>Device:</p> <p>MCP73831: Single-Cell Charge Controller MCP73831T: Single-Cell Charge Controller (Tape and Reel)</p> <p>MCP73832: Single-Cell Charge Controller MCP73832T: Single-Cell Charge Controller (Tape and Reel)</p>																													
<p>Regulation Voltage:</p> <table border="1"> <thead> <tr> <th>Code</th> <th>V_{REG}</th> </tr> </thead> <tbody> <tr> <td>2</td> <td>= 4.20V</td> </tr> <tr> <td>3</td> <td>= 4.35V</td> </tr> <tr> <td>4</td> <td>= 4.40V</td> </tr> <tr> <td>5</td> <td>= 4.50V</td> </tr> </tbody> </table>					Code	V _{REG}	2	= 4.20V	3	= 4.35V	4	= 4.40V	5	= 4.50V															
Code	V _{REG}																												
2	= 4.20V																												
3	= 4.35V																												
4	= 4.40V																												
5	= 4.50V																												
<p>Options: *</p> <table border="1"> <thead> <tr> <th>Code</th> <th>I_{PREG}/I_{REG}</th> <th>V_{PTH}/V_{REG}</th> <th>I_{TERM}/I_{REG}</th> <th>V_{RTH}/V_{REG}</th> </tr> </thead> <tbody> <tr> <td>AC</td> <td>10</td> <td>66.5</td> <td>7.5</td> <td>96.5</td> </tr> <tr> <td>AD</td> <td>10</td> <td>66.5</td> <td>7.5</td> <td>94</td> </tr> <tr> <td>AT</td> <td>10</td> <td>71.5</td> <td>20</td> <td>94</td> </tr> <tr> <td>DC</td> <td>100</td> <td>x</td> <td>7.5</td> <td>96.5</td> </tr> </tbody> </table> <p>* Consult Factory for Alternative Device Options</p>					Code	I _{PREG} /I _{REG}	V _{PTH} /V _{REG}	I _{TERM} /I _{REG}	V _{RTH} /V _{REG}	AC	10	66.5	7.5	96.5	AD	10	66.5	7.5	94	AT	10	71.5	20	94	DC	100	x	7.5	96.5
Code	I _{PREG} /I _{REG}	V _{PTH} /V _{REG}	I _{TERM} /I _{REG}	V _{RTH} /V _{REG}																									
AC	10	66.5	7.5	96.5																									
AD	10	66.5	7.5	94																									
AT	10	71.5	20	94																									
DC	100	x	7.5	96.5																									
<p>Temperature Range:</p> <p>I = -40°C to +85°C (Industrial)</p>																													
<p>Package:</p> <p>MC = Dual-Flat, No-Lead (2x3 mm body), 8-Lead OT = Small Outline Transistor (SOT23), 5-Lead</p>																													
<p>Examples: *</p> <p>a) MCP73831-2ACI/OT: 4.20V V_{REG} Options AC, 5LD SOT23 Pkg</p> <p>b) MCP73831T-2ACI/OT: Tape and Reel, 4.20V V_{REG} Options AC, 5LD SOT23 Pkg</p> <p>c) MCP73832-2ACI/MC: 4.20V V_{REG} Options AC, 8LD DFN Package</p> <p>d) MCP73832T-2ACI/MC: Tape and Reel, 4.20V V_{REG} Options AC, 8LD DFN Package</p> <p>a) MCP73831-2ATI/OT: 4.20V V_{REG} Options AT, 5LD SOT23 Pkg</p> <p>b) MCP73831T-2ATI/OT: Tape and Reel, 4.20V V_{REG} Options AT, 5LD SOT23 Pkg</p> <p>c) MCP73832-2ATI/MC: 4.20V V_{REG} Options AT, 8LD DFN Package</p> <p>d) MCP73832T-2ATI/MC: Tape and Reel, 4.20V V_{REG} Options AT, 8LD DFN Package</p> <p>a) MCP73831-2DCI/OT: 4.20V V_{REG} Options DC, 5LD SOT23 Pkg</p> <p>b) MCP73831T-2DCI/OT: Tape and Reel, 4.20V V_{REG} Options DC, 5LD SOT23 Pkg</p> <p>c) MCP73832-2DCI/MC: 4.20V V_{REG} Options DC, 8LD DFN Package</p> <p>d) MCP73832T-2DCI/MC: Tape and Reel, 4.20V V_{REG} Options DC, 8LD DFN Package</p> <p>a) MCP73831-3ACI/OT: 4.35V V_{REG} Options AC, 5LD SOT23 Pkg</p> <p>b) MCP73831T-3ACI/OT: Tape and Reel, 4.35V V_{REG} Options AC, 5LD SOT23 Pkg</p> <p>c) MCP73832-3ACI/MC: 4.35V V_{REG} Options AC, 8LD DFN Package</p> <p>d) MCP73832T-3ACI/MC: Tape and Reel, 4.35V V_{REG} Options AC, 8LD DFN Package</p> <p>a) MCP73831-4ADI/OT: 4.40V V_{REG} Options AD, 5LD SOT23 Pkg</p> <p>b) MCP73831T-4ADI/OT: Tape and Reel, 4.40V V_{REG} Options AD, 5LD SOT23 Pkg</p> <p>c) MCP73832-4ADI/MC: 4.40V V_{REG} Options AD, 8LD DFN Package</p> <p>d) MCP73832T-4ADI/MC: Tape and Reel, 4.40V V_{REG} Options AD, 8LD DFN Package</p> <p>a) MCP73831-5ACI/OT: 4.50V V_{REG} Options AC, 5LD SOT23 Pkg</p> <p>b) MCP73831T-5ACI/OT: Tape and Reel, 4.50V V_{REG} Options AC, 5LD SOT23 Pkg</p> <p>c) MCP73832-5ACI/MC: 4.50V V_{REG} Options AC, 8LD DFN Package</p> <p>d) MCP73832T-5ACI/MC: Tape and Reel, 4.50V V_{REG} Options AC, 8LD DFN Package</p> <p>* Consult Factory for Alternate Device Options</p>																													

MCP73831/2

NOTES:

Note the following details of the code protection feature on Microchip devices:

- Microchip products meet the specification contained in their particular Microchip Data Sheet.
- Microchip believes that its family of products is one of the most secure families of its kind on the market today, when used in the intended manner and under normal conditions.
- There are dishonest and possibly illegal methods used to breach the code protection feature. All of these methods, to our knowledge, require using the Microchip products in a manner outside the operating specifications contained in Microchip's Data Sheets. Most likely, the person doing so is engaged in theft of intellectual property.
- Microchip is willing to work with the customer who is concerned about the integrity of their code.
- Neither Microchip nor any other semiconductor manufacturer can guarantee the security of their code. Code protection does not mean that we are guaranteeing the product as “unbreakable.”

Code protection is constantly evolving. We at Microchip are committed to continuously improving the code protection features of our products. Attempts to break Microchip's code protection feature may be a violation of the Digital Millennium Copyright Act. If such acts allow unauthorized access to your software or other copyrighted work, you may have a right to sue for relief under that Act.

Information contained in this publication regarding device applications and the like is provided only for your convenience and may be superseded by updates. It is your responsibility to ensure that your application meets with your specifications. MICROCHIP MAKES NO REPRESENTATIONS OR WARRANTIES OF ANY KIND WHETHER EXPRESS OR IMPLIED, WRITTEN OR ORAL, STATUTORY OR OTHERWISE, RELATED TO THE INFORMATION, INCLUDING BUT NOT LIMITED TO ITS CONDITION, QUALITY, PERFORMANCE, MERCHANTABILITY OR FITNESS FOR PURPOSE. Microchip disclaims all liability arising from this information and its use. Use of Microchip devices in life support and/or safety applications is entirely at the buyer's risk, and the buyer agrees to defend, indemnify and hold harmless Microchip from any and all damages, claims, suits, or expenses resulting from such use. No licenses are conveyed, implicitly or otherwise, under any Microchip intellectual property rights.

Trademarks

The Microchip name and logo, the Microchip logo, dsPIC, FlashFlex, KEELOQ, KEELOQ logo, MPLAB, PIC, PICmicro, PICSTART, PIC³² logo, rPIC, SST, SST Logo, SuperFlash and UNI/O are registered trademarks of Microchip Technology Incorporated in the U.S.A. and other countries.

FilterLab, Hampshire, HI-TECH C, Linear Active Thermistor, MTP, SEEVAL and The Embedded Control Solutions Company are registered trademarks of Microchip Technology Incorporated in the U.S.A.

Silicon Storage Technology is a registered trademark of Microchip Technology Inc. in other countries.

Analog-for-the-Digital Age, Application Maestro, BodyCom, chipKIT, chipKIT logo, CodeGuard, dsPICDEM, dsPICDEM.net, dsPICworks, dsSPEAK, ECAN, ECONOMONITOR, FanSense, HI-TIDE, In-Circuit Serial Programming, ICSP, Mindi, MiWi, MPASM, MPF, MPLAB Certified logo, MPLIB, MPLINK, mTouch, Omniclient Code Generation, PICC, PICC-18, PICDEM, PICDEM.net, PICkit, PICtail, REAL ICE, rLAB, Select Mode, SQI, Serial Quad I/O, Total Endurance, TSHARC, UniWinDriver, WiperLock, ZENA and Z-Scale are trademarks of Microchip Technology Incorporated in the U.S.A. and other countries.

SQTP is a service mark of Microchip Technology Incorporated in the U.S.A.

GestIC and ULPP are registered trademarks of Microchip Technology Germany II GmbH & Co. & KG, a subsidiary of Microchip Technology Inc., in other countries.

All other trademarks mentioned herein are property of their respective companies.

© 2005-2013, Microchip Technology Incorporated, Printed in the U.S.A., All Rights Reserved.

 Printed on recycled paper.

ISBN: 978-1-62077-260-7

Microchip received ISO/TS-16949:2009 certification for its worldwide headquarters, design and wafer fabrication facilities in Chandler and Tempe, Arizona; Gresham, Oregon and design centers in California and India. The Company's quality system processes and procedures are for its PIC[®] MCUs and dsPIC[®] DSCs, KEELOQ[®] code hopping devices, Serial EEPROMs, microperipherals, nonvolatile memory and analog products. In addition, Microchip's quality system for the design and manufacture of development systems is ISO 9001:2000 certified.

QUALITY MANAGEMENT SYSTEM
CERTIFIED BY DNV
== ISO/TS 16949 ==



MICROCHIP

Worldwide Sales and Service

AMERICAS

Corporate Office
2355 West Chandler Blvd.
Chandler, AZ 85224-6199
Tel: 480-792-7200
Fax: 480-792-7277
Technical Support:
<http://www.microchip.com/support>
Web Address:
www.microchip.com

Atlanta
Duluth, GA
Tel: 678-957-9614
Fax: 678-957-1455

Boston
Westborough, MA
Tel: 774-760-0087
Fax: 774-760-0088

Chicago
Itasca, IL
Tel: 630-285-0071
Fax: 630-285-0075

Cleveland
Independence, OH
Tel: 216-447-0464
Fax: 216-447-0643

Dallas
Addison, TX
Tel: 972-818-7423
Fax: 972-818-2924

Detroit
Farmington Hills, MI
Tel: 248-538-2250
Fax: 248-538-2260

Indianapolis
Noblesville, IN
Tel: 317-773-8323
Fax: 317-773-5453

Los Angeles
Mission Viejo, CA
Tel: 949-462-9523
Fax: 949-462-9608

Santa Clara
Santa Clara, CA
Tel: 408-961-6444
Fax: 408-961-6445

Toronto
Mississauga, Ontario,
Canada
Tel: 905-673-0699
Fax: 905-673-6509

ASIA/PACIFIC

Asia Pacific Office
Suites 3707-14, 37th Floor
Tower 6, The Gateway
Harbour City, Kowloon
Hong Kong
Tel: 852-2401-1200
Fax: 852-2401-3431

Australia - Sydney
Tel: 61-2-9868-6733
Fax: 61-2-9868-6755

China - Beijing
Tel: 86-10-8569-7000
Fax: 86-10-8528-2104

China - Chengdu
Tel: 86-28-8665-5511
Fax: 86-28-8665-7889

China - Chongqing
Tel: 86-23-8980-9588
Fax: 86-23-8980-9500

China - Hangzhou
Tel: 86-571-2819-3187
Fax: 86-571-2819-3189

China - Hong Kong SAR
Tel: 852-2943-5100
Fax: 852-2401-3431

China - Nanjing
Tel: 86-25-8473-2460
Fax: 86-25-8473-2470

China - Qingdao
Tel: 86-532-8502-7355
Fax: 86-532-8502-7205

China - Shanghai
Tel: 86-21-5407-5533
Fax: 86-21-5407-5066

China - Shenyang
Tel: 86-24-2334-2829
Fax: 86-24-2334-2393

China - Shenzhen
Tel: 86-755-8864-2200
Fax: 86-755-8203-1760

China - Wuhan
Tel: 86-27-5980-5300
Fax: 86-27-5980-5118

China - Xian
Tel: 86-29-8833-7252
Fax: 86-29-8833-7256

China - Xiamen
Tel: 86-592-2388138
Fax: 86-592-2388130

China - Zhuhai
Tel: 86-756-3210040
Fax: 86-756-3210049

ASIA/PACIFIC

India - Bangalore
Tel: 91-80-3090-4444
Fax: 91-80-3090-4123

India - New Delhi
Tel: 91-11-4160-8631
Fax: 91-11-4160-8632

India - Pune
Tel: 91-20-2566-1512
Fax: 91-20-2566-1513

Japan - Osaka
Tel: 81-6-6152-7160
Fax: 81-6-6152-9310

Japan - Tokyo
Tel: 81-3-6880-3770
Fax: 81-3-6880-3771

Korea - Daegu
Tel: 82-53-744-4301
Fax: 82-53-744-4302

Korea - Seoul
Tel: 82-2-554-7200
Fax: 82-2-558-5932 or
82-2-558-5934

Malaysia - Kuala Lumpur
Tel: 60-3-6201-9857
Fax: 60-3-6201-9859

Malaysia - Penang
Tel: 60-4-227-8870
Fax: 60-4-227-4068

Philippines - Manila
Tel: 63-2-634-9065
Fax: 63-2-634-9069

Singapore
Tel: 65-6334-8870
Fax: 65-6334-8850

Taiwan - Hsin Chu
Tel: 886-3-5778-366
Fax: 886-3-5770-955

Taiwan - Kaohsiung
Tel: 886-7-213-7828
Fax: 886-7-330-9305

Taiwan - Taipei
Tel: 886-2-2508-8600
Fax: 886-2-2508-0102

Thailand - Bangkok
Tel: 66-2-694-1351
Fax: 66-2-694-1350

EUROPE

Austria - Wels
Tel: 43-7242-2244-39
Fax: 43-7242-2244-393

Denmark - Copenhagen
Tel: 45-4450-2828
Fax: 45-4485-2829

France - Paris
Tel: 33-1-69-53-63-20
Fax: 33-1-69-30-90-79

Germany - Munich
Tel: 49-89-627-144-0
Fax: 49-89-627-144-44

Italy - Milan
Tel: 39-0331-742611
Fax: 39-0331-466781

Netherlands - Drunen
Tel: 31-416-690399
Fax: 31-416-690340

Spain - Madrid
Tel: 34-91-708-08-90
Fax: 34-91-708-08-91

UK - Wokingham
Tel: 44-118-921-5869
Fax: 44-118-921-5820

11/29/12

Mouser Electronics

Authorized Distributor

Click to View Pricing, Inventory, Delivery & Lifecycle Information:

[Microchip:](#)

[MCP73831T-3ACI/OT](#) [MCP73832T-2ACI/MC](#)