

### General Description

The MIC5265 is a 150mA LDO in lead-free Thin SOT-23-5 packaging ideal for applications where cost is the priority. The MIC5265 is ideal for any application in portable electronics, including both RF and Digital applications. With low output noise and high PSRR, the MIC5265 is ideal for noise sensitive applications such as RF. While the fast transient response and active shutdown circuitry makes it well-suited for powering digital circuitry.

The MIC5265 has a 2.7V to 5.5V input operating voltage range, making it ideal for operation from a single cell lithium ion battery or fixed 3.3V and 5V systems. The MIC5265 come with an enable pin and can be put into a zero off-mode current state.

The MIC5265 offers low dropout voltage (210mV at 150mA), low output noise (57 $\mu$ Vrms), high PSRR and integrates an active shutdown circuit on the output of each regulator to discharge the output voltage when disabled.

Data sheets and supporting documentation can be found on Micrel's web site at: [www.micrel.com](http://www.micrel.com)

### Features

- 2.7V to 5.5V supply voltage.
- Low 75 $\mu$ A quiescent current per LDO.
- Thin SOT-23-5 package.
- Low Noise – 57 $\mu$ Vrms.
- High PSRR – 60dB at 1kHz.
- Low dropout voltage – 210mV at 150mA.
- Stable with ceramic output capacitors.
- Fast transient response.
- Active shutdown.

### Applications

- Cellular Telephones
- PDAs
- GPS Receivers

### Typical Application

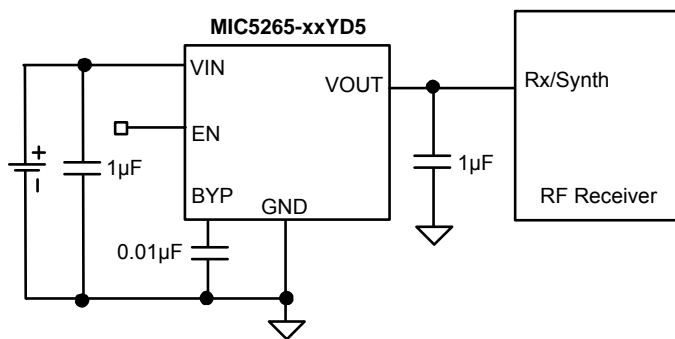

RF Power Supply

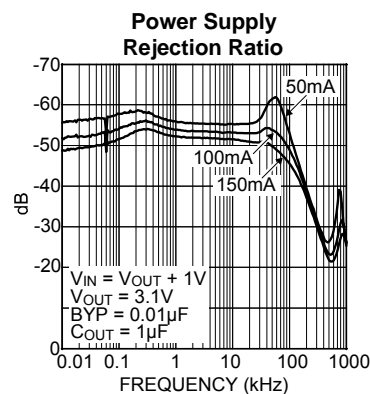

## Ordering Information

Part Number	Output Voltage	Marking Code	Junction Temp. Range	Package
MIC5265-1.5YD5	1.5V	<u>N715</u>	-40°C to +125°C	Pb-Free Thin SOT-23-5
MIC5265-1.8YD5	1.8V	<u>N718</u>	-40°C to +125°C	Pb-Free Thin SOT-23-5
MIC5265-1.85YD5	1.85V	<u>N71J</u>	-40°C to +125°C	Pb-Free Thin SOT-23-5
MIC5265-2.5YD5	2.5V	<u>N725</u>	-40°C to +125°C	Pb-Free Thin SOT-23-5
MIC5265-2.6YD5	2.6V	<u>N726</u>	-40°C to +125°C	Pb-Free Thin SOT-23-5
MIC5265-2.7YD5	2.7V	<u>N727</u>	-40°C to +125°C	Pb-Free Thin SOT-23-5
MIC5265-2.8YD5	2.8V	<u>N728</u>	-40°C to +125°C	Pb-Free Thin SOT-23-5
MIC5265-2.85YD5	2.85V	<u>N72J</u>	-40°C to +125°C	Pb-Free Thin SOT-23-5
MIC5265-2.9YD5	2.9V	<u>N729</u>	-40°C to +125°C	Pb-Free Thin SOT-23-5
MIC5265-3.0YD5	3.0V	<u>N730</u>	-40°C to +125°C	Pb-Free Thin SOT-23-5
MIC5265-3.1YD5	3.1V	<u>N731</u>	-40°C to +125°C	Pb-Free Thin SOT-23-5
MIC5265-3.2YD5	3.2V	<u>N732</u>	-40°C to +125°C	Pb-Free Thin SOT-23-5
MIC5265-3.3YD5	3.3V	<u>N733</u>	-40°C to +125°C	Pb-Free Thin SOT-23-5

**Note:**

1. Other Voltage Combinations available. Contact Micrel, Inc. for details.

## Pin Configuration

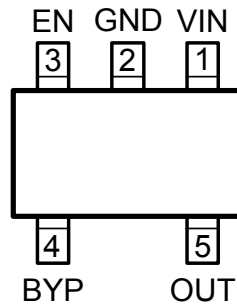

Lead-Free Thin SOT-23-5 (M5)

## Pin Description

Pin Number	Pin Name	Pin Function
1	IN	Supply Voltage
2	GND	Ground
3	EN	Enable/Shutdown (Input): CMOS compatible input. Logic high = enable; logic low = shutdown. Do not leave open.
4	BYP	Reference Bypass: Connect external $0.01\mu\text{F} \leq C_{\text{BYP}} \leq 1.0\mu\text{F}$ capacitor to GND to reduce output noise. May be left open.
5	OUT	Regulator Output

**Absolute Maximum Ratings<sup>(1)</sup>**

Supply Input Voltage ( $V_{IN}$ )	0V to +7V
Enable Input Voltage ( $V_{EN1}$ )	0V to +7V
Power Dissipation ( $P_D$ )	Internally Limited <sup>(3)</sup>
Junction Temperature ( $T_J$ )	-40°C to 125°C
Lead Temperature (soldering, #sec.)	260°C
Storage Temperature ( $T_S$ )	-55°C to 150°C
EDS Rating <sup>(4)</sup>	2kV

**Operating Ratings<sup>(2)</sup>**

Supply Input Voltage ( $V_{IN}$ )	+2.7V to +5.5V
Enable Input Voltage ( $V_{EN}$ )	0V to $V_{IN}$
Junction Temperature ( $T_A$ )	-40°C to +125°C
Junction Thermal Resistance	
Thin SOT-23-5 ( $\theta_{JA}$ )	235°C/W

**Electrical Characteristics<sup>(5)</sup>**

$V_{EN} = V_{IN} = V_{OUT} + 1V$ ;  $I_L = 100\mu A$ ;  $C_L = 1.0\mu F$ ;  $C_{BYP} = 0.01\mu F$  per output;  $T_A = 25^\circ C$ , **bold** values indicate  $-40^\circ C \leq T_A \leq +85^\circ C$ ; unless noted.

Parameter	Condition	Min	Typ	Max	Units
Output Voltage Accuracy	$I_{OUT} = 100\mu A$	-2 <b>-3</b>		2 <b>3</b>	% %
Line Regulation	$V_{IN} = V_{OUT} + 1V$ to 5.5V		0.05	0.2	%
Load Regulation	$I_{OUT} = 0.1mA$ to 150mA		2	3	%
Dropout Voltage	$I_{OUT} = 50mA$ $I_{OUT} = 150mA$		75 210	<b>500</b>	mV mV
Quiescent Current	$V_{EN} < 0.2V$		0.2	<b>2</b>	$\mu A$
Ground Pin Current	$I_{OUT} = 0mA$ $I_{OUT} = 150mA$		75 80	<b>120</b> <b>150</b>	$\mu A$ $\mu A$
PSRR (Ripple Rejection)	$f = 100Hz$ , $C_{BYP} = 0.1\mu F$ , $I_{LOAD} = 50mA$ $f = 1kHz$ , $C_{BYP} = 0.1\mu F$ , $I_{LOAD} = 50mA$ $f = 10kHz$ , $C_{BYP} = 0.1\mu F$ , $I_{LOAD} = 50mA$		62 64 64		dB dB dB
Current Limit	$V_{OUT} = 0V$		225		mA
Output Noise	$C_{OUT} = 1.0\mu F$ , $C_{BYP} = 0.1\mu F$ , $f = 10Hz$ to 100kHz		57		$\mu V$ (rms)
<b>Enable Input (EN1 and EN2)</b>					
Enable Input Logic Low	$V_{IN} = 2.7V$ to 5.5V, regulator shutdown			<b>0.2</b>	V
Enable Input Logic High	$V_{IN} = 2.7V$ to 5.5V, regulator enabled	<b>1.6</b>			V
Enable Input Current	$V_{IL} < 0.4V$ , regulator shutdown $V_{IH} > 1.6V$ , regulator enabled		0.01 0.01		$\mu A$ $\mu A$
<b>Thermal Shutdown</b>					
Thermal Shutdown Temperature			150		$^\circ C$
Hysteresis			10		$^\circ C$
<b>Turn-on/Turn-off Characteristics</b>					
Turn-on Time			40	<b>150</b>	$\mu s$
Discharge Resistance			500		$\Omega$

**Notes:**

- Exceeding the absolute maximum rating may damage the device.
- The device is not guaranteed to function outside its operating rating.
- The maximum allowable power dissipation of any  $T_A$  (ambient temperature) is  $P_{D(max)} = (T_{J(max)} - T_A) / \theta_{JA}$ . Exceeding the maximum allowable power dissipation will result in excessive die temperature, and the regulator will go into thermal shutdown. The  $\theta_{JA}$  of the MIC5265x.XYD5 (all versions) is 235°C/W on a PC board (see "Thermal Considerations" section for further details).
- Devices are ESD sensitive. Handling precautions recommended. Human body model, 1.5k in series with 100pF.
- Specification for packaged product only.

# Typical Characteristics

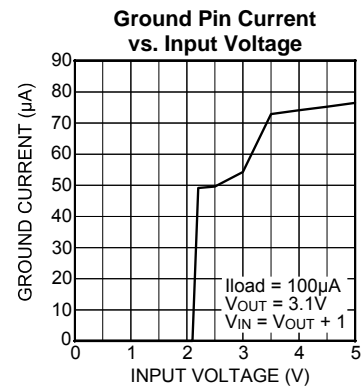
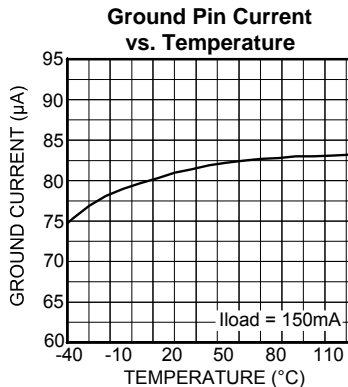
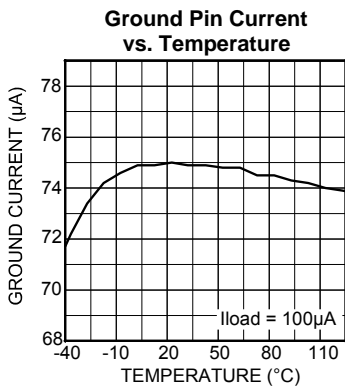
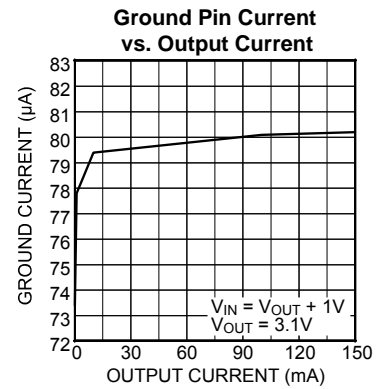
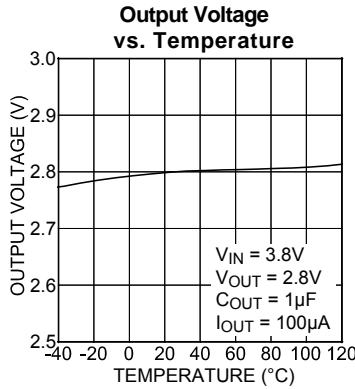
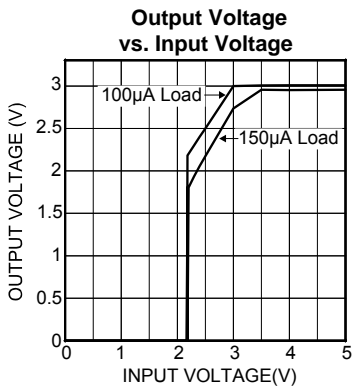
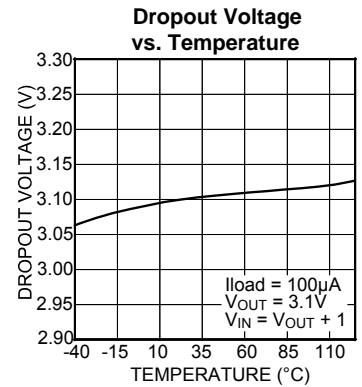
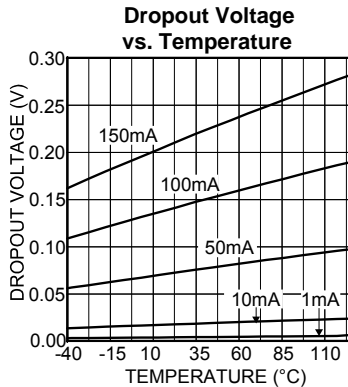
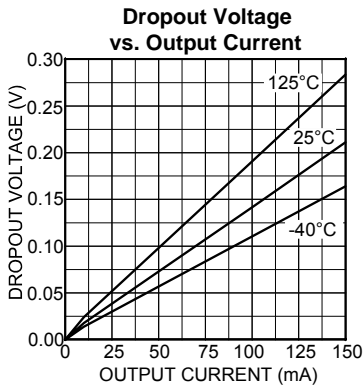
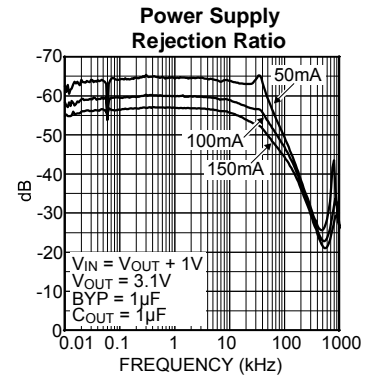
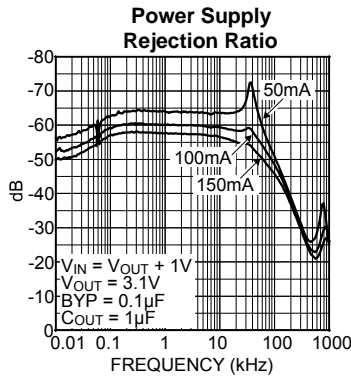
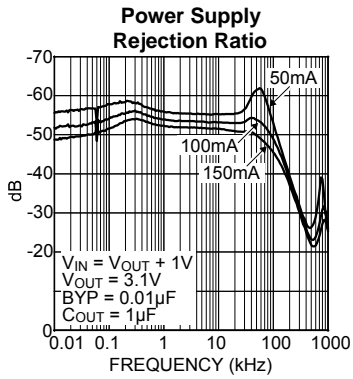

### Typical Characteristics (continued)

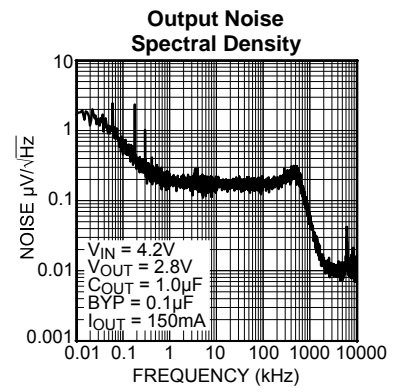
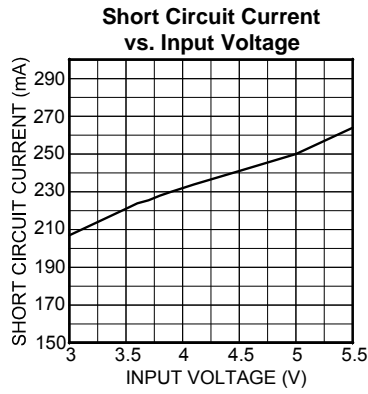
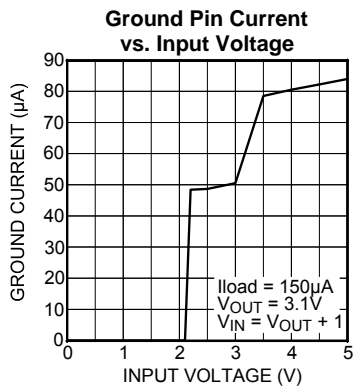

# Functional Characteristics

### Line Transient Response

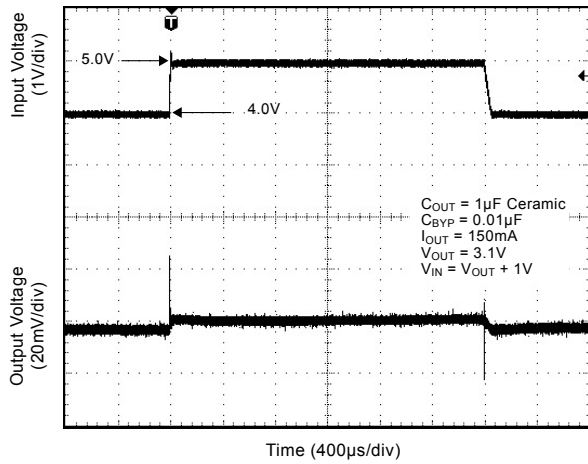

### Load Transient Response

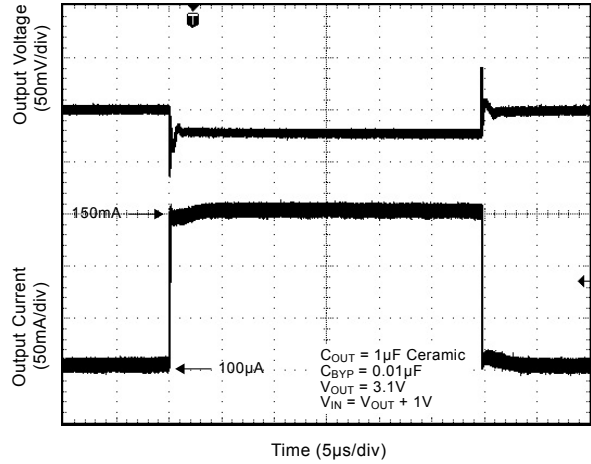

### Enable Pin Delay

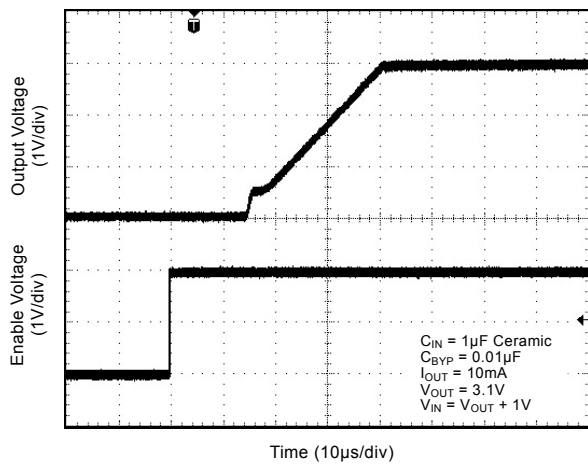

### Shutdown Delay

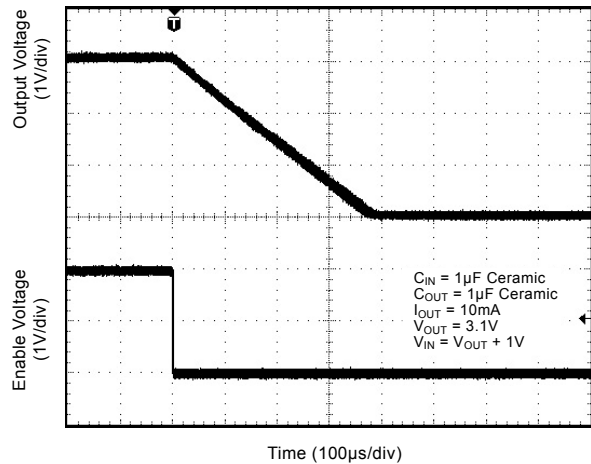

### Block Diagram

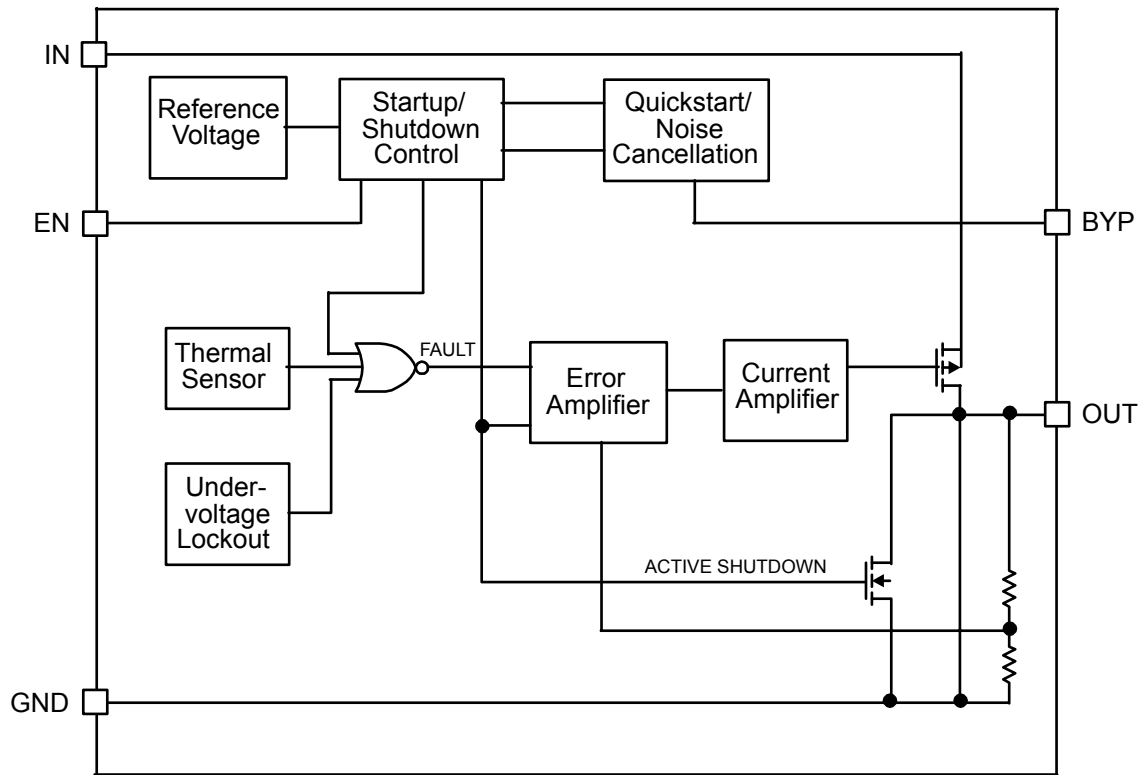

MIC5265 Diagram



## Applications Information

### Enable/Shutdown

The MIC5265 comes with an active-high enable pin that allows the regulator in each output to be disabled. Forcing the enable pin low disables the regulator and sends it into a “zero” off-mode current state. In this state, current consumed by the regulator goes nearly to zero. Forcing the enable pin high enables the output voltage. This part is CMOS and the enable pin cannot be left floating; a floating enable pin may cause an indeterminate state on the output.

### Input Capacitor

The MIC5265 is a high performance, high bandwidth device. Therefore, it requires well-bypassed input supplies for optimal performance. A 1 $\mu$ F capacitor is required from the input to ground to provide stability. Low-ESR ceramic capacitors provide optimal performance at a minimum of space. Additional high-frequency capacitors, such as small valued NPO dielectric type capacitors, help filter out high-frequency noise and are good practice in any RF-based circuit.

### Output Capacitor

The MIC5265 requires an output capacitor for stability. The design requires 1 $\mu$ F or greater on each output to maintain stability. The design is optimized for use with low-ESR ceramic chip capacitors. High ESR capacitors may cause high frequency oscillation. The maximum recommended ESR is 300m $\Omega$ . The output capacitor can be increased, but performance has been optimized for a 1 $\mu$ F ceramic output capacitor and does not improve significantly with larger capacitance.

X7R/X5R dielectric-type ceramic capacitors are recommended because of their temperature performance. X7Rtype capacitors change capacitance by 15% over their operating temperature range and are the most stable type of ceramic capacitors. Z5U and Y5V dielectric capacitors change value by as much as 50% and 60%, respectively, over their operating temperature ranges. To use a ceramic chip capacitor with Y5V dielectric, the value must be much higher than an X7R ceramic capacitor to ensure the same minimum capacitance over the equivalent operating temperature range.

### Bypass Capacitor

A capacitor can be placed from the noise bypass pin to ground to reduce output voltage noise. The capacitor bypasses the internal reference. A 0.01 $\mu$ F capacitor is recommended for applications that require low-noise outputs. The bypass capacitor can be increased, further reducing noise and improving PSRR. Turn-on time increases slightly with respect to bypass capacitance. A unique quick-start circuit allows the MIC5265 to drive a

large capacitor on the bypass pin without significantly slowing turn-on time.

### Active Shutdown

The MIC5265 also features an active shutdown clamp, which is an N-channel MOSFET that turns on when the device is disabled. This allows the output capacitor and load to discharge, de-energizing the load.

### No-Load Stability

The MIC5265 will remain stable and in regulation with no load unlike many other voltage regulators. This is especially important in CMOS RAM keep-alive applications.

### Thermal Considerations

The MIC5265 is designed to provide 150mA of continuous current per output in a very small package. Maximum ambient operating temperature can be calculated based on the output current and the voltage drop across the part. Given that the input voltage is 5.0V, the output voltage is 2.8V, and the output current is 100mA.

The actual power dissipation of the regulator circuit can be determined using the equation:

$$PD = (VIN - VOUT) IOUT + VIN IGND$$

Because this device is CMOS and the ground current is typically <100 $\mu$ A over the load range, the power dissipation contributed by the ground current is < 1% and can be ignored for this calculation.

$$PD = (5.0V - 2.8V) \times 150mA$$

$$PD = 0.33W$$

To determine the maximum ambient operating temperature of the package, use the junction-to-ambient thermal resistance of the device and the following basic equation:

$$P_{D(max)} = \left( \frac{T_{J(max)} - T_A}{\theta_{JA}} \right)$$

TJ(max) = 125°C, the max. junction temperature of the die  
 $\theta_{JA}$  thermal resistance = 235°C/W

**MIC5265 Junction-To-Ambient Thermal Resistance**

Package	$\theta_{JA}$ Recommended Minimum Footprint	$\theta_{JA}$ 1" Sq. Copper Clad	$\theta_{JC}$
SOT-23-5 (M5 or D5)	235°C/W	125°C	145°C/W

**Thermal Resistance**

Substituting PD for PD(max) and solving for the ambient operating temperature will give the maximum operating conditions for the regulator circuit. The junction-to-ambient thermal resistance for the minimum footprint is 235°C/W. The maximum power dissipation must not be exceeded for proper operation.

For example, when operating the MIC5265-2.8YD5 at an input voltage of 5.0V at 150mA with a minimum footprint layout, the maximum ambient operating temperature TA can be determined as follows:

$$0.33W = \frac{125^{\circ}\text{C} - T_A}{235^{\circ}\text{C} / W}$$

$$T_A = 47.45^{\circ}\text{C}$$

Therefore, a 2.8V application at 150mA of output current can accept an ambient operating temperature of 47°C in a SOT-23-5 package. For a full discussion of heat sinking and thermal effects on voltage regulators, refer to the "Regulator Thermals" section of Micrel's Designing with Low-Dropout Voltage Regulators handbook. This information can be found on Micrel's website at:

[http://www.micrel.com/\\_PDF/other/LDOBk\\_ds.pdf](http://www.micrel.com/_PDF/other/LDOBk_ds.pdf)

Package Information

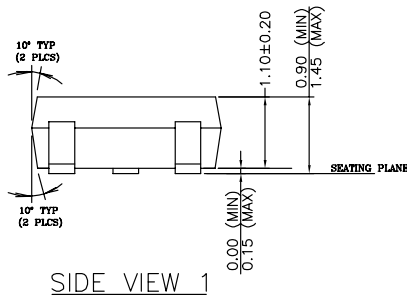
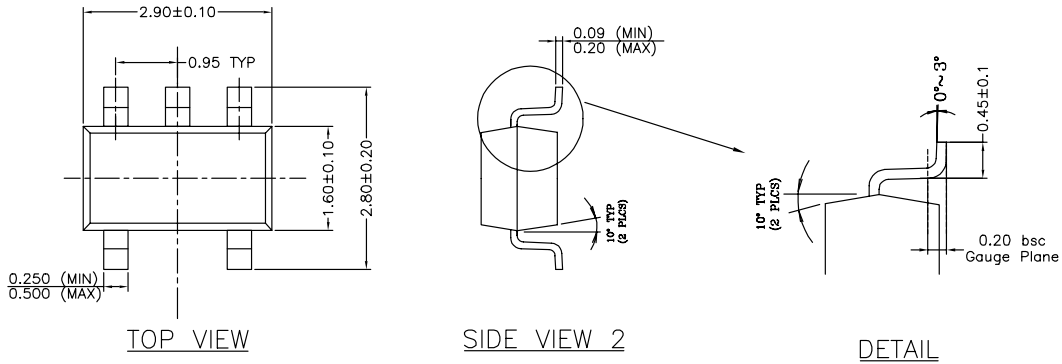

- NOTE:
1. PACKAGE OUTLINE EXCLUSIVE OF MOLD FLASH & BURR.
  2. PACKAGE OUTLINE INCLUSIVE OF SOLER PLATING.
  3. DIMENSION AND TOLERANCE PER ANSI Y14.5M, 1982.
  4. FOOT LENGTH MEASUREMENT BASED ON GAUGE PLANE METHOD.
  5. DIE FACES UP FOR MOLD, AND FACES DOWN FOR TRIM/FORM.

Thin SOT-23-5 (M5)

**MICREL, INC. 2180 FORTUNE DRIVE SAN JOSE, CA 95131 USA**  
 TEL +1 (408) 944-0800 FAX +1 (408) 474-1000 WEB <http://www.micrel.com>

The information furnished by Micrel in this data sheet is believed to be accurate and reliable. However, no responsibility is assumed by Micrel for its use. Micrel reserves the right to change circuitry and specifications at any time without notification to the customer.

Micrel Products are not designed or authorized for use as components in life support appliances, devices or systems where malfunction of a product can reasonably be expected to result in personal injury. Life support devices or systems are devices or systems that (a) are intended for surgical implant into the body or (b) support or sustain life, and whose failure to perform can be reasonably expected to result in a significant injury to the user. A Purchaser's use or sale of Micrel Products for use in life support appliances, devices or systems is a Purchaser's own risk and Purchaser agrees to fully indemnify Micrel for any damages resulting from such use or sale.

© 2005 Micrel, Incorporated.

# Mouser Electronics

Authorized Distributor

Click to View Pricing, Inventory, Delivery & Lifecycle Information:

## Micrel:

[MIC5265-2.7YD5 TR](#) [MIC5265-2.8YD5 TR](#) [MIC5265-1.8YD5 TR](#) [MIC5265-2.85YD5 TR](#) [MIC5265-2.6YD5 TR](#)  
[MIC5265-2.5YD5 TR](#) [MIC5265-2.9YD5 TR](#) [MIC5265-3.0YD5 TR](#) [MIC5265-3.2YD5 TR](#) [MIC5265-3.1YD5-TR](#)  
[MIC5265-3.2YD5-TR](#) [MIC5265-1.5YD5-TR](#) [MIC5265-2.9YD5-TR](#) [MIC5265-2.8YMT-TR](#) [MIC5265-2.6YD5-TR](#)  
[MIC5265-1.8YD5-TR](#) [MIC5265-3.3YD5-TR](#) [MIC5265-2.5YD5-TR](#) [MIC5265-3.0YD5-TR](#) [MIC5265-2.8YD5-TR](#)

## Microchip:

[MIC5265-2.85YD5-TR](#) [MIC5265-1.85YD5-TR](#) [MIC5265-2.7YD5-TR](#)