

# RF Power Field Effect Transistor

## N-Channel Enhancement-Mode Lateral MOSFET

Designed for CDMA base station applications with frequencies from 700 to 1000 MHz. Can be used in Class AB and Class C for all typical cellular base station modulation formats.

- Typical Single-Carrier W-CDMA Performance:  $V_{DD} = 28$  Volts,  $I_{DQ} = 800$  mA,  $P_{out} = 33$  Watts Avg., IQ Magnitude Clipping, Channel Bandwidth = 3.84 MHz, Input Signal PAR = 7.5 dB @ 0.01% Probability on CCDF.

Frequency	$G_{ps}$ (dB)	$\eta_D$ (%)	Output PAR (dB)	ACPR (dBc)
920 MHz	20.1	34.6	6.3	-37.2
940 MHz	20.0	34.3	6.3	-37.3
960 MHz	19.8	34.2	6.3	-37.4

- Capable of Handling 10:1 VSWR, @ 32 Vdc, 940 MHz, 120 Watts CW Output Power (3 dB Input Overdrive from Rated  $P_{out}$ ), Designed for Enhanced Ruggedness
- Typical  $P_{out}$  @ 1 dB Compression Point  $\approx 120$  Watts CW

### 880 MHz

- Typical Single-Carrier W-CDMA Performance:  $V_{DD} = 28$  Volts,  $I_{DQ} = 800$  mA,  $P_{out} = 33$  Watts Avg., IQ Magnitude Clipping, Channel Bandwidth = 3.84 MHz, Input Signal PAR = 7.5 dB @ 0.01% Probability on CCDF.

Frequency	$G_{ps}$ (dB)	$\eta_D$ (%)	Output PAR (dB)	ACPR (dBc)
865 MHz	20.8	35.0	6.2	-37.1
880 MHz	20.8	35.0	6.2	-37.5
895 MHz	20.6	34.8	6.2	-38.0

### Features

- 100% PAR Tested for Guaranteed Output Power Capability
- Characterized with Series Equivalent Large-Signal Impedance Parameters and Common Source S-Parameters
- Internally Matched for Ease of Use
- Integrated ESD Protection
- Greater Negative Gate-Source Voltage Range for Improved Class C Operation
- Designed for Digital Predistortion Error Correction Systems
- Optimized for Doherty Applications
- 225°C Capable Plastic Package
- RoHS Compliant
- In Tape and Reel. R3 Suffix = 250 Units per 32 mm, 13 inch Reel.

**Table 1. Maximum Ratings**

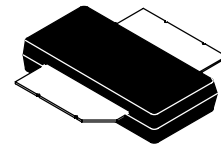
Rating	Symbol	Value	Unit
Drain-Source Voltage	$V_{DSS}$	-0.5, +70	Vdc
Gate-Source Voltage	$V_{GS}$	-6.0, +10	Vdc
Operating Voltage	$V_{DD}$	32, +0	Vdc
Storage Temperature Range	$T_{stg}$	-65 to +150	°C
Case Operating Temperature	$T_C$	150	°C
Operating Junction Temperature (1,2)	$T_J$	225	°C

1. Continuous use at maximum temperature will affect MTTF.

2. MTTF calculator available at <http://www.freescale.com/rf>. Select Software & Tools/Development Tools/Calculators to access MTTF calculators by product.

**MRF8S9120NR3**

**865-960 MHz, 33 W AVG., 28 V  
SINGLE W-CDMA  
LATERAL N-CHANNEL  
RF POWER MOSFET**



**CASE 2021-03, STYLE 1  
OM-780-2  
PLASTIC**

**Table 2. Thermal Characteristics**

Characteristic	Symbol	Value (1,2)	Unit
Thermal Resistance, Junction to Case Case Temperature 76°C, 33 W CW, 28 Vdc, I <sub>DQ</sub> = 800 mA, 960 MHz Case Temperature 76°C, 120 W CW, 28 Vdc, I <sub>DQ</sub> = 800 mA, 960 MHz	R <sub>θJC</sub>	0.62 0.51	°C/W

**Table 3. ESD Protection Characteristics**

Test Methodology	Class
Human Body Model (per JESD22-A114)	2 (Minimum)
Machine Model (per EIA/JESD22-A115)	A (Minimum)
Charge Device Model (per JESD22-C101)	IV (Minimum)

**Table 4. Moisture Sensitivity Level**

Test Methodology	Rating	Package Peak Temperature	Unit
Per JESD22-A113, IPC/JEDEC J-STD-020	3	260	°C

**Table 5. Electrical Characteristics** (T<sub>A</sub> = 25°C unless otherwise noted)

Characteristic	Symbol	Min	Typ	Max	Unit
----------------	--------	-----	-----	-----	------

**Off Characteristics**

Zero Gate Voltage Drain Leakage Current (V <sub>DS</sub> = 70 Vdc, V <sub>GS</sub> = 0 Vdc)	I <sub>DSS</sub>	—	—	10	μAdc
Zero Gate Voltage Drain Leakage Current (V <sub>DS</sub> = 28 Vdc, V <sub>GS</sub> = 0 Vdc)	I <sub>DSS</sub>	—	—	1	μAdc
Gate-Source Leakage Current (V <sub>GS</sub> = 5 Vdc, V <sub>DS</sub> = 0 Vdc)	I <sub>GSS</sub>	—	—	1	μAdc

**On Characteristics**

Gate Threshold Voltage (V <sub>DS</sub> = 10 Vdc, I <sub>D</sub> = 460 μAdc)	V <sub>GS(th)</sub>	1.4	2.2	2.9	Vdc
Gate Quiescent Voltage (V <sub>DD</sub> = 28 Vdc, I <sub>D</sub> = 800 mAdc, Measured in Functional Test)	V <sub>GS(Q)</sub>	2.3	3.1	3.8	Vdc
Drain-Source On-Voltage (V <sub>GS</sub> = 10 Vdc, I <sub>D</sub> = 2 Adc)	V <sub>DS(on)</sub>	0.1	0.2	0.3	Vdc

**Functional Tests** <sup>(3)</sup> (In Freescale Test Fixture, 50 ohm system) V<sub>DD</sub> = 28 Vdc, I<sub>DQ</sub> = 800 mA, P<sub>out</sub> = 33 W Avg., f = 960 MHz, Single-Carrier W-CDMA, IQ Magnitude Clipping, Input Signal PAR = 7.5 dB @ 0.01% Probability on CCDF. ACPR measured in 3.84 MHz Channel Bandwidth @ ±5 MHz Offset.

Power Gain	G <sub>ps</sub>	19.0	19.8	22.0	dB
Drain Efficiency	η <sub>D</sub>	33.0	34.2	—	%
Output Peak-to-Average Ratio @ 0.01% Probability on CCDF	PAR	6.0	6.3	—	dB
Adjacent Channel Power Ratio	ACPR	—	-37.4	-36.4	dBc
Input Return Loss	IRL	—	-20	-12	dB

**Typical Broadband Performance** (In Freescale Test Fixture, 50 ohm system) V<sub>DD</sub> = 28 Vdc, I<sub>DQ</sub> = 800 mA, P<sub>out</sub> = 33 W Avg., Single-Carrier W-CDMA, IQ Magnitude Clipping, Input Signal PAR = 7.5 dB @ 0.01% Probability on CCDF. ACPR measured in 3.84 MHz Channel Bandwidth @ ±5 MHz Offset.

Frequency	G <sub>ps</sub> (dB)	η <sub>D</sub> (%)	Output PAR (dB)	ACPR (dBc)	IRL (dB)
920 MHz	20.1	34.6	6.3	-37.2	-14
940 MHz	20.0	34.3	6.3	-37.3	-24
960 MHz	19.8	34.2	6.3	-37.4	-20

1. MTTF calculator available at <http://www.freescale.com/rf>. Select Software & Tools/Development Tools/Calculators to access MTTF calculators by product.
2. Refer to AN1955, *Thermal Measurement Methodology of RF Power Amplifiers*. Go to <http://www.freescale.com/rf>. Select Documentation/Application Notes - AN1955.
3. Part internally matched both on input and output.

(continued)

**Table 5. Electrical Characteristics** ( $T_A = 25^\circ\text{C}$  unless otherwise noted) (continued)

Characteristic	Symbol	Min	Typ	Max	Unit
<b>Typical Performances</b> (In Freescale Test Fixture, 50 ohm system) $V_{DD} = 28\text{ Vdc}$ , $I_{DQ} = 800\text{ mA}$ , 920-960 MHz Bandwidth					
$P_{out}$ @ 1 dB Compression Point, CW	P1dB	—	120	—	W
IMD Symmetry @ 52 W PEP, $P_{out}$ where IMD Third Order Intermodulation $\cong 30\text{ dBc}$ (Delta IMD Third Order Intermodulation between Upper and Lower Sidebands $> 2\text{ dB}$ )	IMD <sub>sym</sub>	—	16	—	MHz
VBW Resonance Point (IMD Third Order Intermodulation Inflection Point)	VBW <sub>res</sub>	—	46	—	MHz
Gain Flatness in 40 MHz Bandwidth @ $P_{out} = 33\text{ W Avg.}$	$G_F$	—	0.3	—	dB
Gain Variation over Temperature ( $-30^\circ\text{C}$ to $+85^\circ\text{C}$ )	$\Delta G$	—	0.016	—	dB/ $^\circ\text{C}$
Output Power Variation over Temperature ( $-30^\circ\text{C}$ to $+85^\circ\text{C}$ )	$\Delta P1\text{dB}$	—	0.002	—	dB/ $^\circ\text{C}$

**Typical Broadband Performance — 880 MHz** (In Freescale 880 MHz Test Fixture, 50 ohm system)  $V_{DD} = 28\text{ Vdc}$ ,  $I_{DQ} = 800\text{ mA}$ ,  $P_{out} = 33\text{ W Avg.}$ , Single-Carrier W-CDMA, IQ Magnitude Clipping, Input Signal PAR = 7.5 dB @ 0.01% Probability on CCDF. ACPR measured in 3.84 MHz Channel Bandwidth @  $\pm 5\text{ MHz}$  Offset.

Frequency	$G_{ps}$ (dB)	$\eta_D$ (%)	Output PAR (dB)	ACPR (dBc)	IRL (dB)
865 MHz	20.8	35.0	6.2	-37.1	-12
880 MHz	20.8	35.0	6.2	-37.5	-13
895 MHz	20.6	34.8	6.2	-38.0	-13

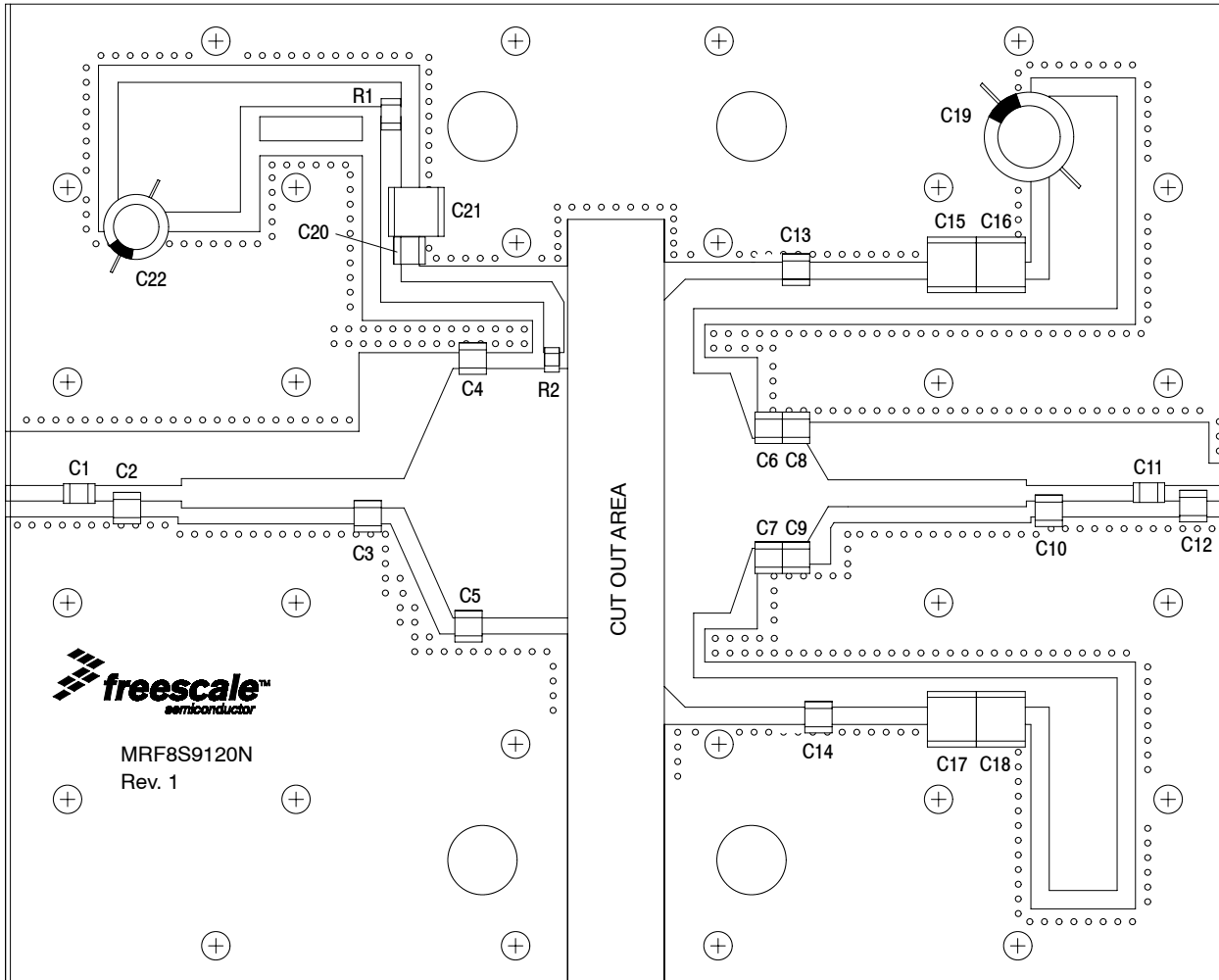
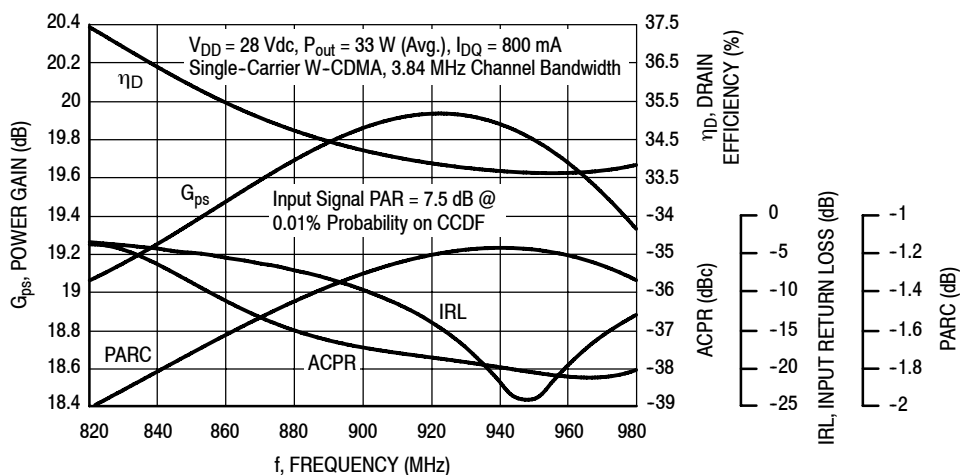


Figure 1. MRF8S9120NR3 Test Circuit Component Layout

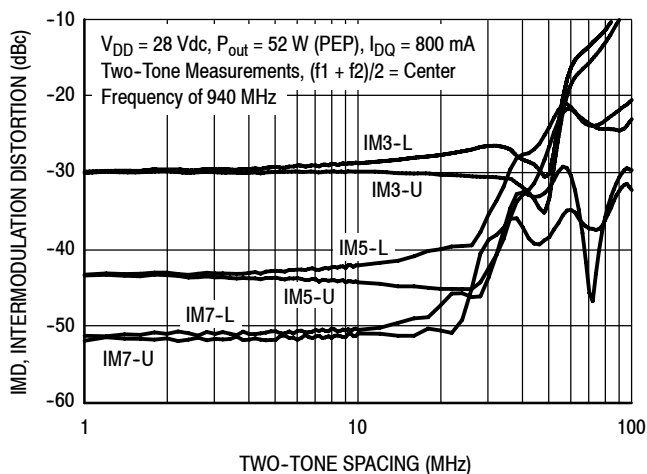
Table 6. MRF8S9120NR3 Test Circuit Component Designations and Values

Part	Description	Part Number	Manufacturer
C1, C11, C20	39 pF Chip Capacitors	ATC100B390JT500XT	ATC
C2	1.8 pF Chip Capacitor	ATC100B1R8BT500XT	ATC
C3	2.0 pF Chip Capacitor	ATC100B2R0BT500XT	ATC
C4, C10	2.7 pF Chip Capacitors	ATC100B2R7BT500XT	ATC
C5	6.8 pF Chip Capacitor	ATC100B6R8CT500XT	ATC
C6, C7	7.5 pF Chip Capacitors	ATC100B7R5CT500XT	ATC
C8, C9	2.2 pF Chip Capacitors	ATC100B2R2JT500XT	ATC
C12	0.8 pF Chip Capacitor	ATC100B0R8BT500XT	ATC
C13, C14	43 pF Chip Capacitors	ATC100B430JT500XT	ATC
C15, C16, C17, C18, C21	10 $\mu$ F Chip Capacitors	GRM55DR61H106KA88L	Murata
C19	470 $\mu$ F, 63 V Chip Capacitor	MCGPR63V477M13X26-RH	Multicomp
C22	47 $\mu$ F, 50 V Chip Capacitor	476KXM050M	Illinois Capacitor
R1	3.3 $\Omega$ , 1/4 W Chip Resistor	P3.3VCT-ND	Panasonic
R2	10 $\Omega$ , 1/4 W Chip Resistor	CRCW120610R0JNEA	Vishay
PCB	0.030", $\epsilon_r = 3.5$	RF-35A2	Taconic

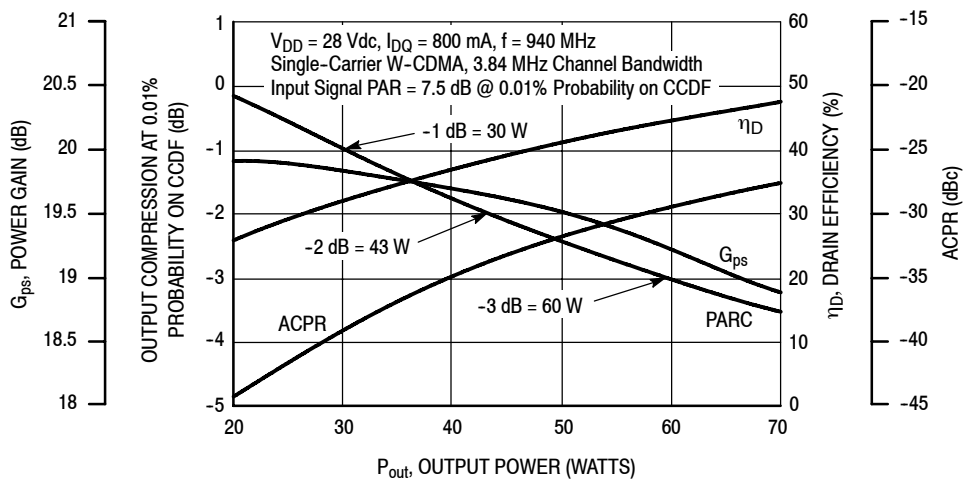
### TYPICAL CHARACTERISTICS



**Figure 2. Output Peak-to-Average Ratio Compression (PARC) Broadband Performance @  $P_{out} = 33$  Watts Avg.**

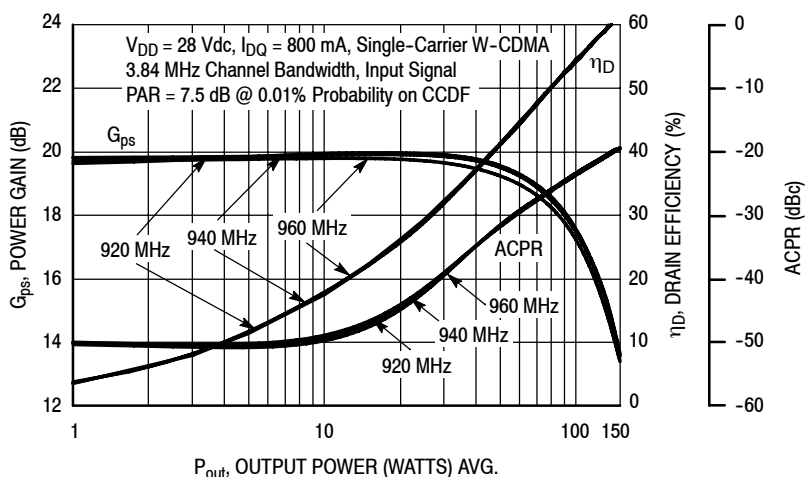


**Figure 3. Intermodulation Distortion Products versus Two-Tone Spacing**

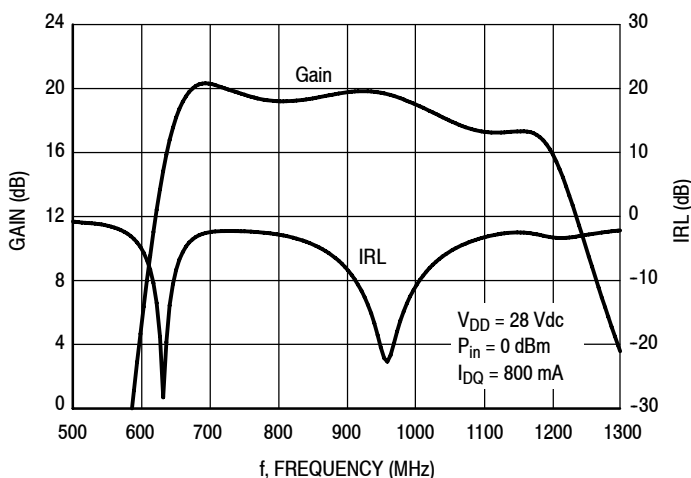


**Figure 4. Output Peak-to-Average Ratio Compression (PARC) versus Output Power**

### TYPICAL CHARACTERISTICS

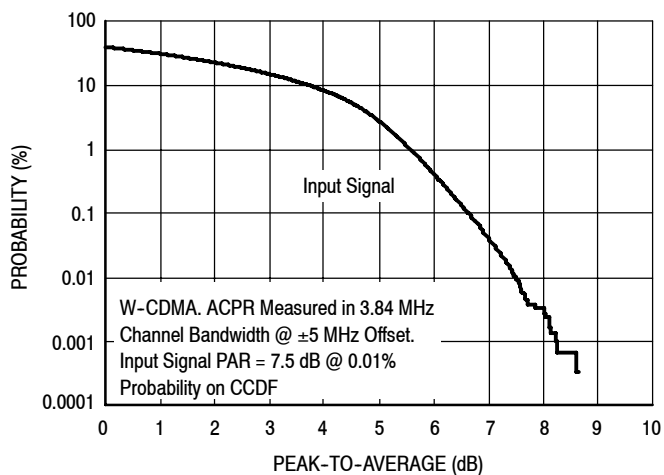


**Figure 5. Single-Carrier W-CDMA Power Gain, Drain Efficiency and ACPR versus Output Power**

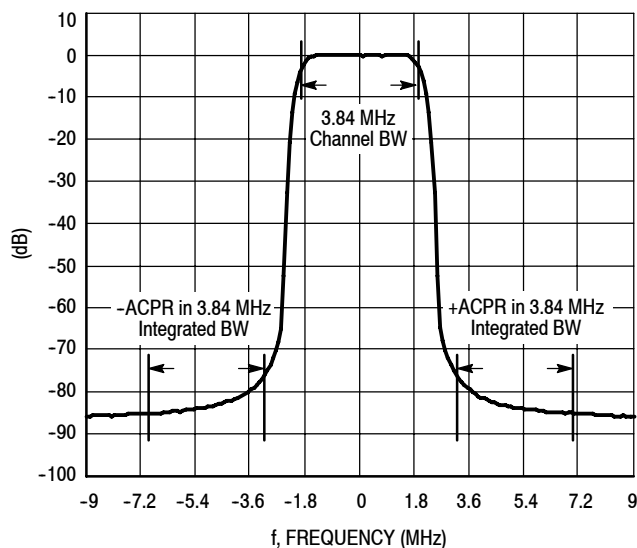


**Figure 6. Broadband Frequency Response**

### W-CDMA TEST SIGNAL



**Figure 7. CCDF W-CDMA IQ Magnitude Clipping, Single-Carrier Test Signal**



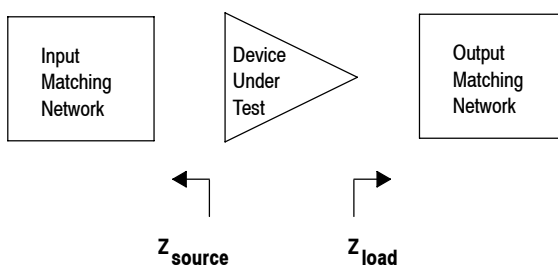
**Figure 8. Single-Carrier W-CDMA Spectrum**

$V_{DD} = 28 \text{ Vdc}$ ,  $I_{DQ} = 800 \text{ mA}$ ,  $P_{out} = 33 \text{ W Avg.}$

f MHz	$Z_{source}$ $\Omega$	$Z_{load}$ $\Omega$
820	$2.75 - j0.48$	$3.19 + j0.87$
840	$2.67 - j0.21$	$2.95 + j1.16$
860	$2.61 - j0.06$	$2.73 + j1.45$
880	$2.56 + j0.32$	$2.54 + j1.74$
900	$2.51 + j0.56$	$2.36 + j2.01$
920	$2.48 + j0.80$	$2.19 + j2.29$
940	$2.43 + j1.03$	$2.03 + j2.57$
960	$2.39 + j1.24$	$1.89 + j2.85$
980	$2.36 + j1.46$	$1.77 + j3.12$

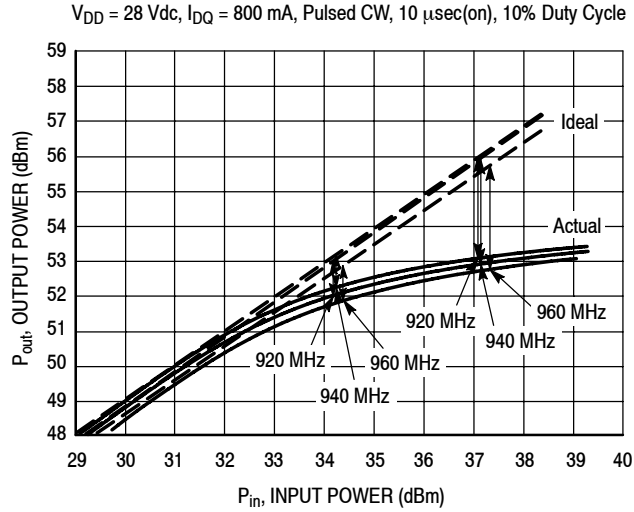
$Z_{source}$  = Test circuit impedance as measured from gate to ground.

$Z_{load}$  = Test circuit impedance as measured from drain to ground.



**Figure 9. Series Equivalent Source and Load Impedance**

## ALTERNATIVE PEAK TUNE LOAD PULL CHARACTERISTICS



f (MHz)	P1dB		P3dB	
	Watts	dBm	Watts	dBm
920	168	52.3	202	53.1
940	160	52.0	195	52.9
960	154	51.9	188	52.7

Test Impedances per Compression Level

f (MHz)		$Z_{\text{source}}$ $\Omega$	$Z_{\text{load}}$ $\Omega$
920	P1dB	$1.45 - j2.02$	$1.28 - j2.39$
940	P1dB	$1.78 - j1.81$	$1.35 - j2.74$
960	P1dB	$1.78 - j2.35$	$1.33 - j2.99$

**Figure 10. Pulsed CW Output Power versus Input Power @ 28 V**



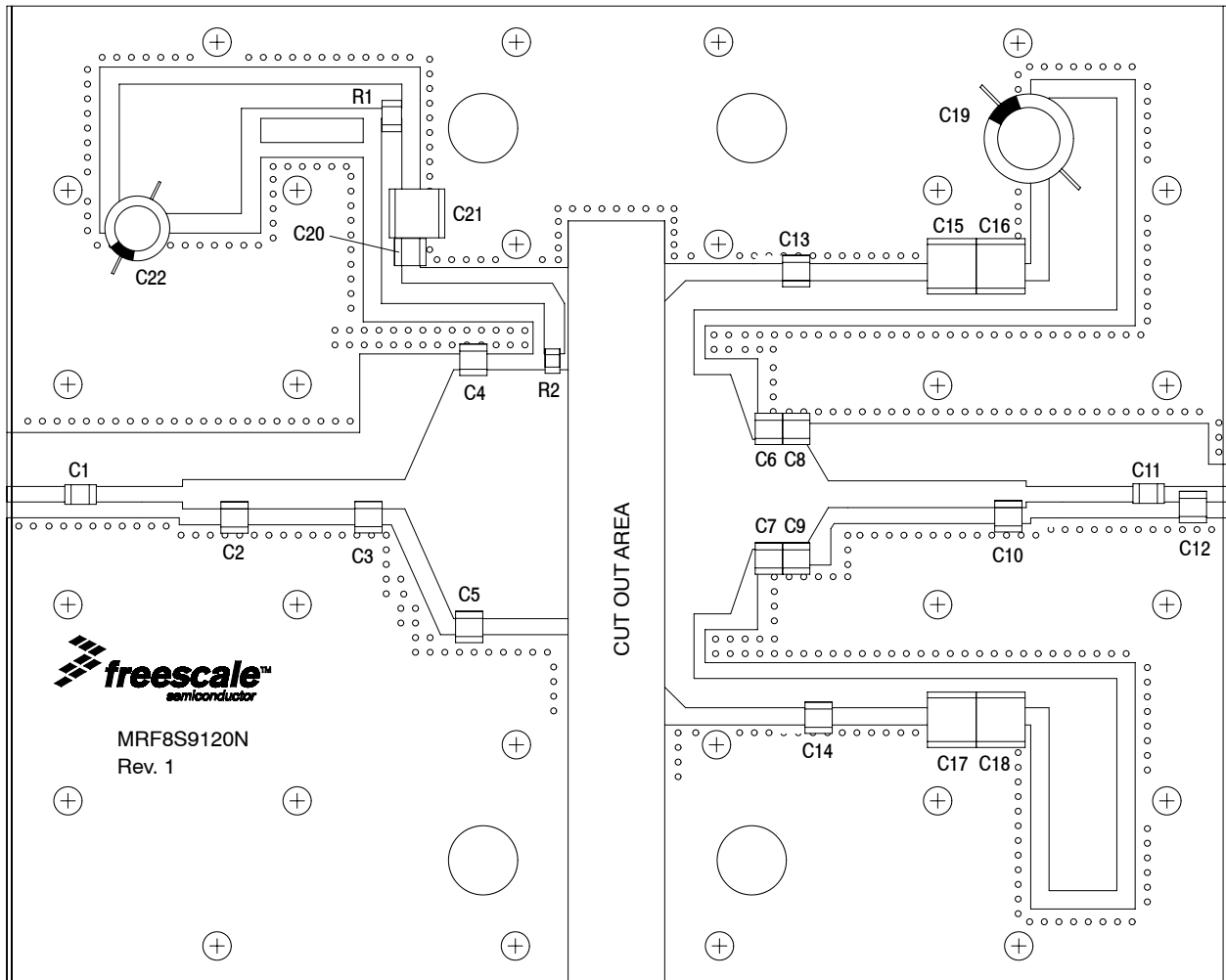
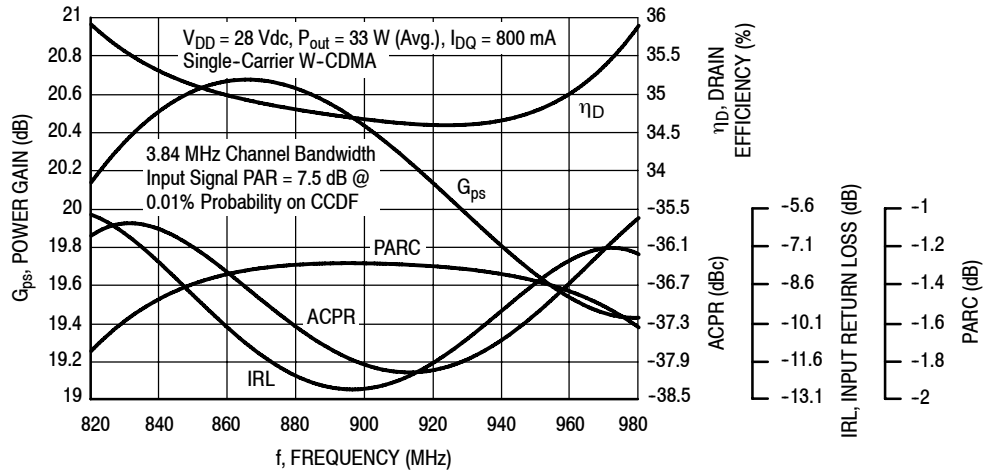


Figure 11. MRF8S9120NR3 Test Circuit Component Layout — 880 MHz

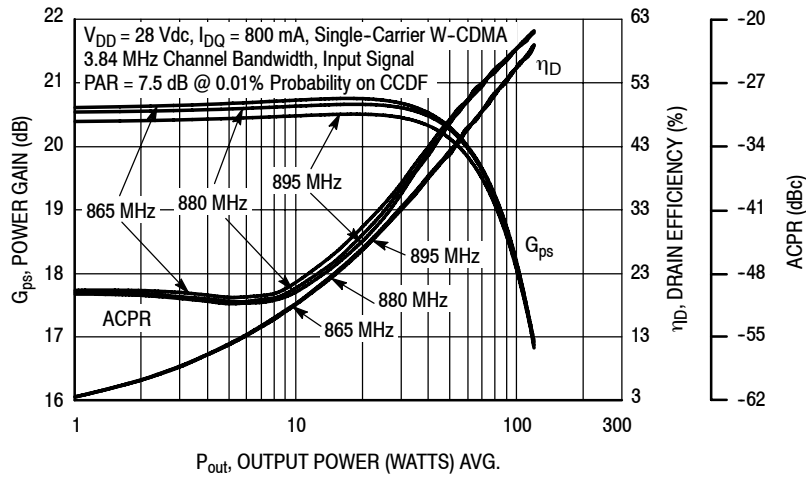
Table 7. MRF8S9120NR3 Test Circuit Component Designations and Values — 880 MHz

Part	Description	Part Number	Manufacturer
C1, C11, C20	47 pF Chip Capacitors	ATC100B470JT500XT	ATC
C2, C3, C4	3.3 pF Chip Capacitors	ATC100B3R3BT500XT	ATC
C5, C6, C7	7.5 pF Chip Capacitors	ATC100B7R5CT500XT	ATC
C8, C9	2.2 pF Chip Capacitors	ATC100B2R2JT500XT	ATC
C10	2.7 pF Chip Capacitor	ATC100B2R7BT500XT	ATC
C12	0.8 pF Chip Capacitor	ATC100B0R8BT500XT	ATC
C13, C14	43 pF Chip Capacitors	ATC100B430JT500XT	ATC
C15, C16, C17, C18, C21	10 $\mu$ F Chip Capacitors	GRM55DR61H106KA88L	Murata
C19	470 $\mu$ F, 63 V Electrolytic Capacitor	MCGPR63V477M13X26-RH	Multicomp
C22	47 $\mu$ F, 50 V Electrolytic Capacitor	476KXM050M	Illinois Capacitor
R1	3.3 $\Omega$ , 1/4 W Chip Resistor	P3.3VCT-ND	Panasonic
R2	10 $\Omega$ , 1/4 W Chip Resistor	CRCW120610R0JNEA	Vishay
PCB	0.030", $\epsilon_r = 3.5$	RF-35A2	Taconic

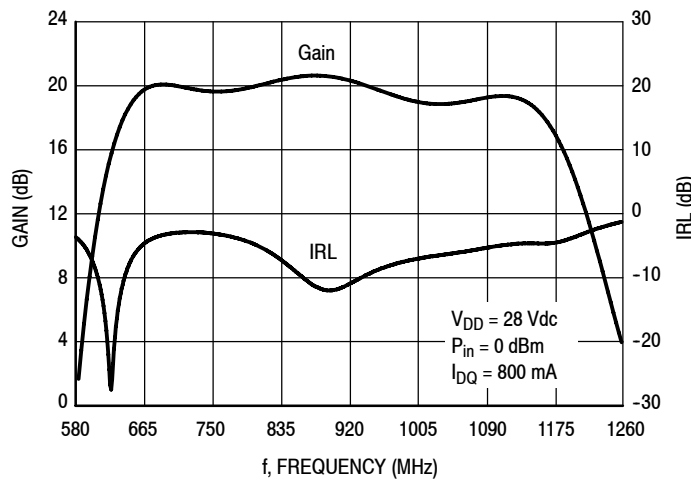
### TYPICAL CHARACTERISTICS — 880 MHz



**Figure 12. Output Peak-to-Average Ratio Compression (PARC) Broadband Performance @  $P_{out}$  = 33 Watts Avg.**



**Figure 13. Single-Carrier W-CDMA Power Gain, Drain Efficiency and ACPR versus Output Power**



**Figure 14. Broadband Frequency Response**

$V_{DD} = 28 \text{ Vdc}$ ,  $I_{DQ} = 800 \text{ mA}$ ,  $P_{out} = 33 \text{ W Avg.}$

f MHz	$Z_{source}$ $\Omega$	$Z_{load}$ $\Omega$
820	$2.25 + j0.89$	$2.83 + j1.30$
840	$2.28 + j1.18$	$2.67 + j1.58$
860	$2.33 + j1.45$	$2.52 + j1.87$
880	$2.39 + j1.72$	$2.38 + j1.15$
900	$2.45 + j1.95$	$2.24 + j2.41$
920	$2.53 + j2.18$	$2.12 + j2.68$
940	$2.60 + j2.38$	$1.99 + j2.96$
960	$2.68 + j2.55$	$1.86 + j3.24$
980	$2.77 + j2.71$	$1.75 + j3.53$

$Z_{source}$  = Test circuit impedance as measured from gate to ground.

$Z_{load}$  = Test circuit impedance as measured from drain to ground.

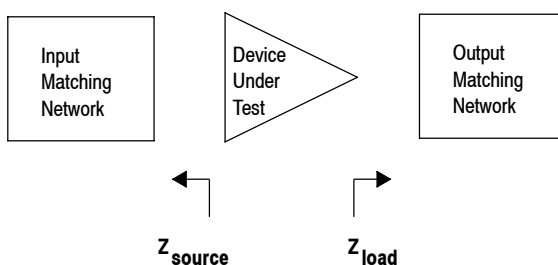
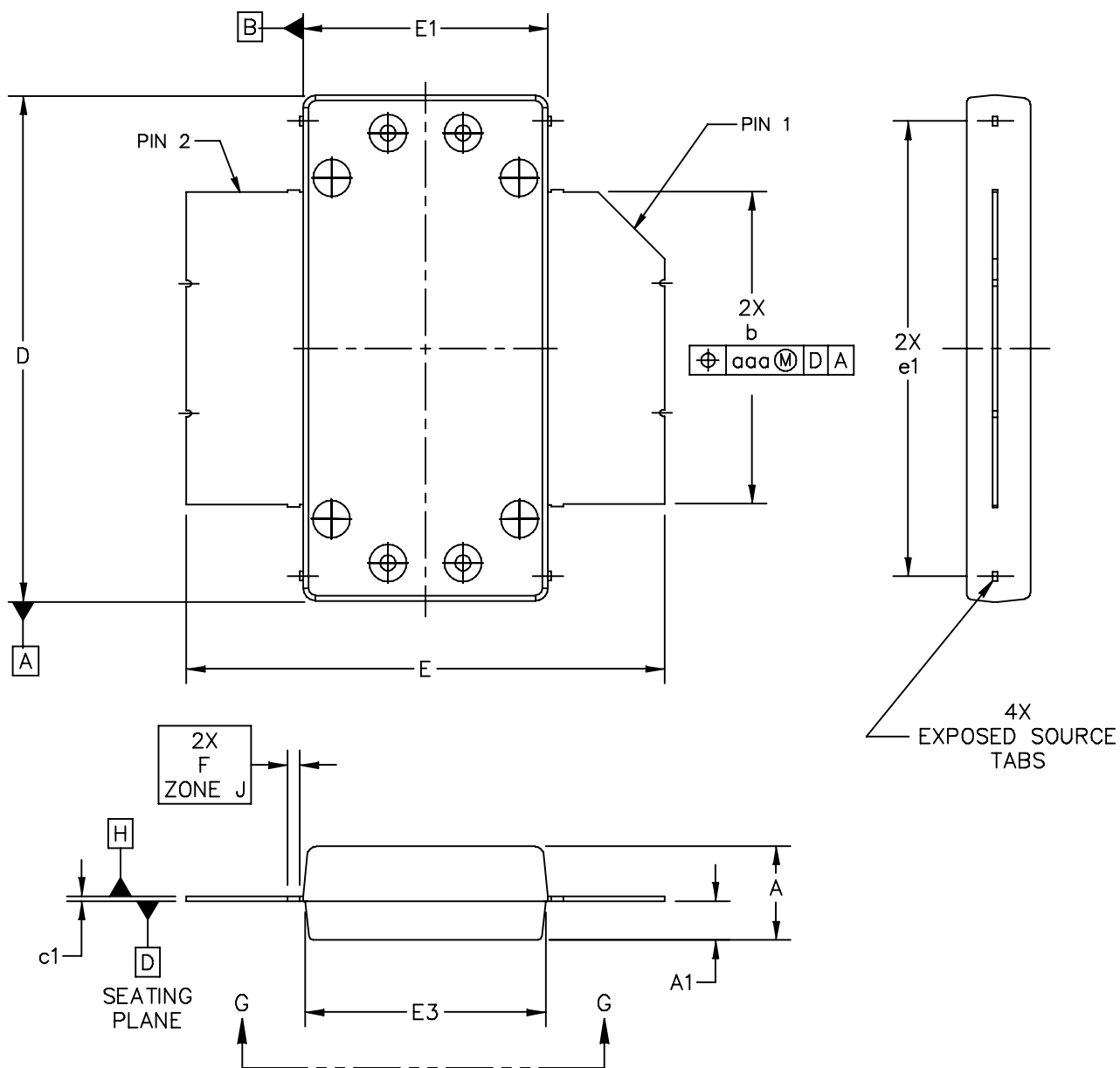
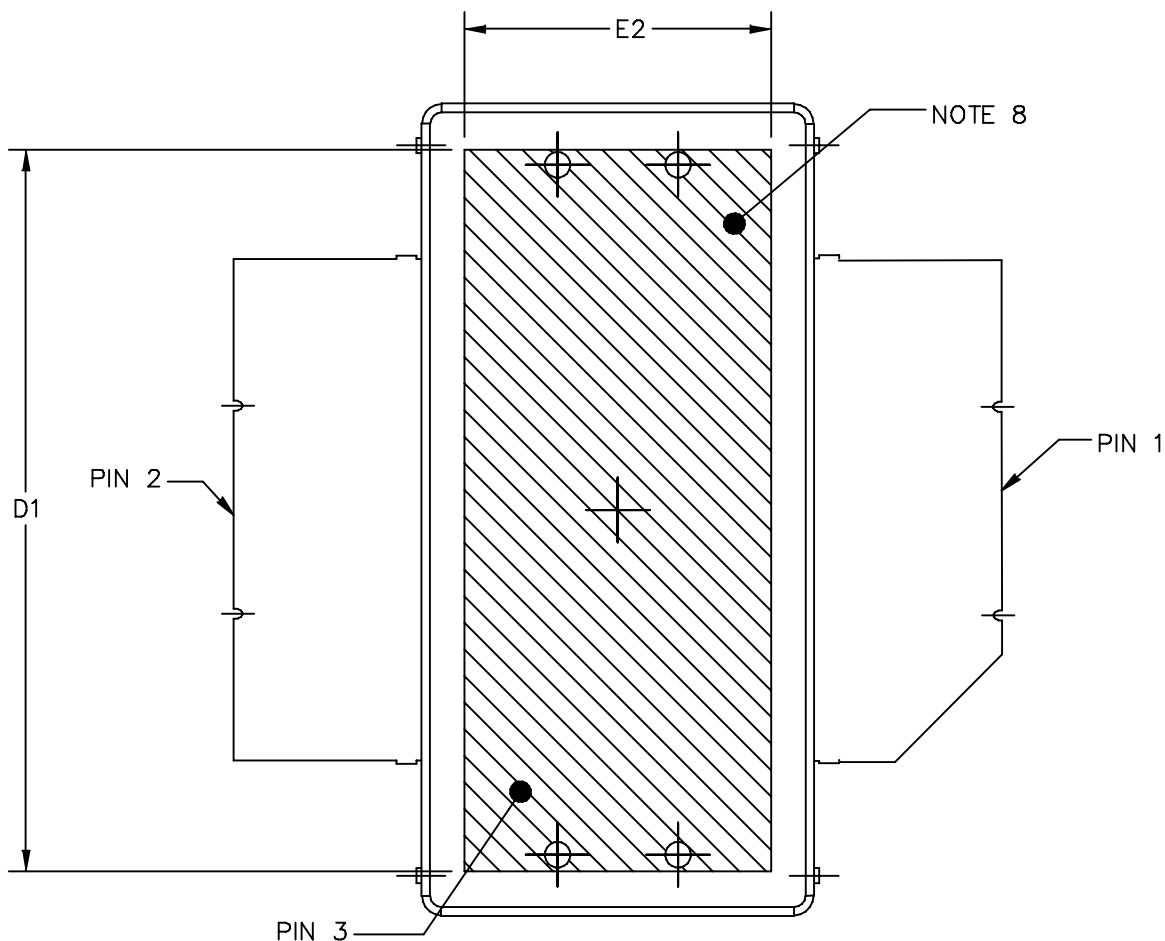


Figure 15. Series Equivalent Source and Load Impedance — 880 MHz

**PACKAGE DIMENSIONS**



© FREESCALE SEMICONDUCTOR, INC. ALL RIGHTS RESERVED.	MECHANICAL OUTLINE	PRINT VERSION NOT TO SCALE
TITLE: <b>OM780-2 STRAIGHT LEAD</b>	DOCUMENT NO: 98ASA10831D	REV: B
	CASE NUMBER: 2021-03	22 OCT 2009
	STANDARD: NON-JEDEC	



BOTTOM VIEW  
VIEW G-G

© FREESCALE SEMICONDUCTOR, INC. ALL RIGHTS RESERVED.	MECHANICAL OUTLINE	PRINT VERSION NOT TO SCALE	
TITLE: OM780-2 STRAIGHT LEAD	DOCUMENT NO: 98ASA10831D	REV: B	
	CASE NUMBER: 2021-03	22 OCT 2009	
	STANDARD: NON-JEDEC		

NOTES:

1. CONTROLLING DIMENSION: INCH
2. INTERPRET DIMENSIONS AND TOLERANCES PER ASME Y14.5M-1994.
3. DATUM PLANE -H- IS LOCATED AT TOP OF LEAD AND IS COINCIDENT WITH THE LEAD WHERE THE LEAD EXITS THE PLASTIC BODY AT THE TOP OF THE PARTING LINE.
4. DIMENSIONS "D" AND "E1" DO NOT INCLUDE MOLD PROTRUSION. ALLOWABLE PROTRUSION IS .006 PER SIDE. DIMENSIONS "D AND "E1" DO INCLUDE MOLD MISMATCH AND ARE DETERMINED AT DATUM PLANE -H-.
5. DIMENSION b DOES NOT INCLUDE DAMBAR PROTRUSION. ALLOWABLE DAMBAR PROTRUSION SHALL BE .005 TOTAL IN EXCESS OF THE b DIMENSION AT MAXIMUM MATERIAL CONDITION.
6. DATUMS -A- AND -B- TO BE DETERMINED AT DATUM PLANE -H-.
7. DIMENSION A1 APPLIES WITHIN ZONE "J" ONLY
8. HATCHING REPRESENTS THE EXPOSED AREA OF THE HEAT SLUG. THE DIMENSIONS D1 AND E2 REPRESENT THE VALUES BETWEEN THE TWO OPPOSITE POINTS ALONG THE EDGES OF EXPOSED AREA OF HEAT SLUG.

STYLE 1:

- PIN 1 - DRAIN
- PIN 2 - GATE
- PIN 3 - SOURCE

DIM	INCH		MILLIMETER		DIM	INCH		MILLIMETER	
	MIN	MAX	MIN	MAX		MIN	MAX	MIN	MAX
A	0.148	.152	3.76	3.86	b	.497	.503	12.62	12.78
A1	.059	.065	1.50	1.65	c1	.007	.011	0.18	0.28
D	.808	.812	20.52	20.62	e1	.721	.729	18.31	18.52
D1	.720	----	18.29	----					
E	.762	.770	19.36	19.56	aaa	.004		0.10	
E1	.390	.394	9.91	10.01					
E2	.306	----	7.77	----					
E3	.383	.387	9.73	9.83					
F	.025 BSC		0.635 BSC						

© FREESCALE SEMICONDUCTOR, INC. ALL RIGHTS RESERVED.		MECHANICAL OUTLINE	PRINT VERSION NOT TO SCALE
TITLE:  OM780-2 STRAIGHT LEAD	DOCUMENT NO: 98ASA10831D		REV: B
	CASE NUMBER: 2021-03		22 OCT 2009
	STANDARD: NON-JEDEC		

## PRODUCT DOCUMENTATION AND SOFTWARE

Refer to the following documents, tools and software to aid your design process.

### Application Notes

- AN1907: Solder Reflow Attach Method for High Power RF Devices in Plastic Packages
- AN1955: Thermal Measurement Methodology of RF Power Amplifiers
- AN3789: Clamping of High Power RF Transistors and RFICs in Over-Molded Plastic Packages

### Engineering Bulletins

- EB212: Using Data Sheet Impedances for RF LDMOS Devices

### Software

- Electromigration MTTF Calculator
- RF High Power Model
- .s2p File

For Software, do a Part Number search at <http://www.freescale.com>, and select the “Part Number” link. Go to the Software & Tools tab on the part’s Product Summary page to download the respective tool.

## REVISION HISTORY

The following table summarizes revisions to this document.

Revision	Date	Description
0	Sept. 2010	• Initial Release of Data Sheet

## **How to Reach Us:**

### **Home Page:**

[www.freescale.com](http://www.freescale.com)

### **Web Support:**

<http://www.freescale.com/support>

### **USA/Europe or Locations Not Listed:**

Freescale Semiconductor, Inc.  
Technical Information Center, EL516  
2100 East Elliot Road  
Tempe, Arizona 85284  
1-800-521-6274 or +1-480-768-2130  
[www.freescale.com/support](http://www.freescale.com/support)

### **Europe, Middle East, and Africa:**

Freescale Halbleiter Deutschland GmbH  
Technical Information Center  
Schatzbogen 7  
81829 Muenchen, Germany  
+44 1296 380 456 (English)  
+46 8 52200080 (English)  
+49 89 92103 559 (German)  
+33 1 69 35 48 48 (French)  
[www.freescale.com/support](http://www.freescale.com/support)

### **Japan:**

Freescale Semiconductor Japan Ltd.  
Headquarters  
ARCO Tower 15F  
1-8-1, Shimo-Meguro, Meguro-ku,  
Tokyo 153-0064  
Japan  
0120 191014 or +81 3 5437 9125  
[support.japan@freescale.com](mailto:support.japan@freescale.com)

### **Asia/Pacific:**

Freescale Semiconductor China Ltd.  
Exchange Building 23F  
No. 118 Jianguo Road  
Chaoyang District  
Beijing 100022  
China  
+86 10 5879 8000  
[support.asia@freescale.com](mailto:support.asia@freescale.com)

### **For Literature Requests Only:**

Freescale Semiconductor Literature Distribution Center  
1-800-441-2447 or +1-303-675-2140  
Fax: +1-303-675-2150  
[LDCForFreescaleSemiconductor@hibbertgroup.com](mailto:LDCForFreescaleSemiconductor@hibbertgroup.com)

Information in this document is provided solely to enable system and software implementers to use Freescale Semiconductor products. There are no express or implied copyright licenses granted hereunder to design or fabricate any integrated circuits or integrated circuits based on the information in this document.

Freescale Semiconductor reserves the right to make changes without further notice to any products herein. Freescale Semiconductor makes no warranty, representation or guarantee regarding the suitability of its products for any particular purpose, nor does Freescale Semiconductor assume any liability arising out of the application or use of any product or circuit, and specifically disclaims any and all liability, including without limitation consequential or incidental damages. "Typical" parameters that may be provided in Freescale Semiconductor data sheets and/or specifications can and do vary in different applications and actual performance may vary over time. All operating parameters, including "Typicals", must be validated for each customer application by customer's technical experts. Freescale Semiconductor does not convey any license under its patent rights nor the rights of others. Freescale Semiconductor products are not designed, intended, or authorized for use as components in systems intended for surgical implant into the body, or other applications intended to support or sustain life, or for any other application in which the failure of the Freescale Semiconductor product could create a situation where personal injury or death may occur. Should Buyer purchase or use Freescale Semiconductor products for any such unintended or unauthorized application, Buyer shall indemnify and hold Freescale Semiconductor and its officers, employees, subsidiaries, affiliates, and distributors harmless against all claims, costs, damages, and expenses, and reasonable attorney fees arising out of, directly or indirectly, any claim of personal injury or death associated with such unintended or unauthorized use, even if such claim alleges that Freescale Semiconductor was negligent regarding the design or manufacture of the part.

Freescale™ and the Freescale logo are trademarks of Freescale Semiconductor, Inc. All other product or service names are the property of their respective owners.

© Freescale Semiconductor, Inc. 2010. All rights reserved.



# Mouser Electronics

Authorized Distributor

Click to View Pricing, Inventory, Delivery & Lifecycle Information:

[Freescale Semiconductor:](#)

[MRF8S9120NR3](#)