



15GN01MA

RF Transistor 8V, 50mA, $f_T=1.5\text{GHz}$, NPN Single MCP

ON Semiconductor®

<http://onsemi.com>

Features

- Small ON-resistance [$R_{on}=2\Omega$ ($I_B=3\text{mA}$)]
- Small output capacitance [$C_{ob}=1.1\text{pF}$ ($V_{CB}=10\text{V}$)]

Specifications

Absolute Maximum Ratings at $T_a=25^\circ\text{C}$

Parameter	Symbol	Conditions	Ratings	Unit
Collector-to-Base Voltage	V_{CBO}		15	V
Collector-to-Emitter Voltage	V_{CEO}		8	V
Emitter-to-Base Voltage	V_{EBO}		3	V
Collector Current	I_C		50	mA
Collector Dissipation	P_C	When mounted on ceramic substrate ($250\text{mm}^2 \times 0.8\text{mm}$)	400	mW
Junction Temperature	T_j		150	$^\circ\text{C}$
Storage Temperature	T_{stg}		-55 to +150	$^\circ\text{C}$

Stresses exceeding Maximum Ratings may damage the device. Maximum Ratings are stress ratings only. Functional operation above the Recommended Operating Conditions is not implied. Extended exposure to stresses above the Recommended Operating Conditions may affect device reliability.

Package Dimensions

unit : mm (typ)

7023A-009

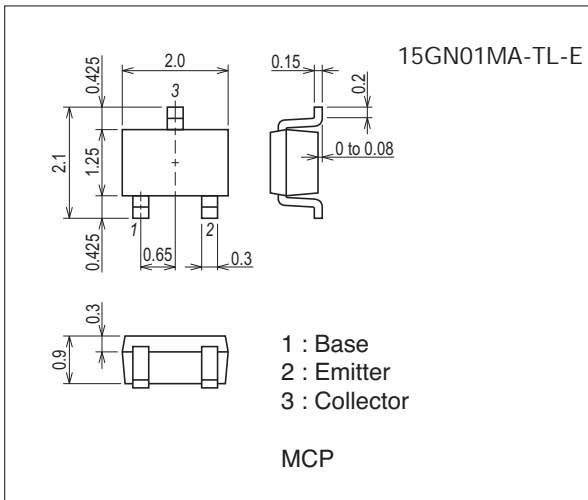

Product & Package Information

- Package : MCP
- JEITA, JEDEC : SC-70, SOT-323
- Minimum Packing Quantity : 3,000 pcs./reel

Packing Type: TL

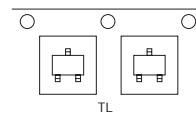

Marking

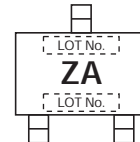

Electrical Connection

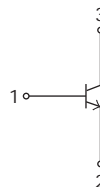

15GN01MA

Electrical Characteristics at Ta=25°C

Parameter	Symbol	Conditions	Ratings			Unit
			min	typ	max	
Collector Cutoff Current	I_{CBO}	$V_{CB}=10V, I_E=0A$			0.5	μA
Emitter Cutoff Current	I_{EBO}	$V_{EB}=2V, I_C=0A$			0.5	μA
DC Current Gain	h_{FE}	$V_{CE}=5V, I_C=10mA$	200		400	
Gain-Bandwidth Product	f_T	$V_{CE}=5V, I_C=10mA$	1.0	1.5		GHz
Output Capacitance	C_{ob}	$V_{CB}=10V, f=1MHz$		1.1	1.5	pF
Collector-to-Emitter Saturation Voltage	$V_{CE(sat)}$	$I_C=20mA, I_B=2mA$		0.06	0.12	V
Output ON resistance	R_{on}	$I_B=3mA, f=10kHz$		2.0		Ω

Ordering Information

Device	Package	Shipping	memo
15GN01MA-TL-E	MCP	3,000pcs./reel	Pb Free

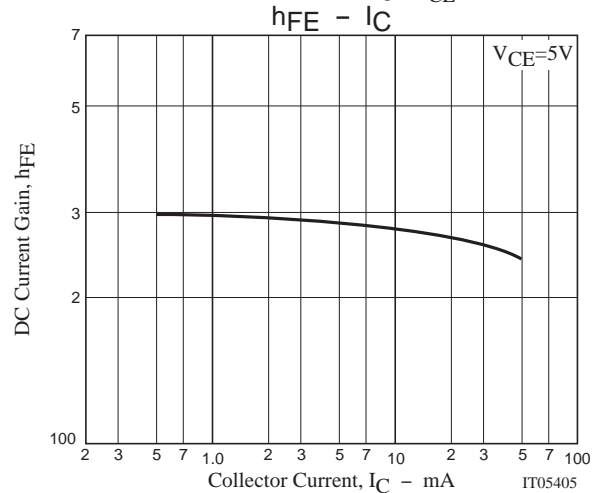
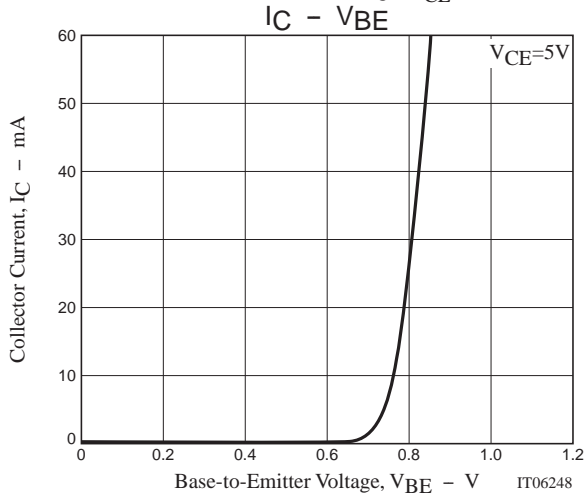
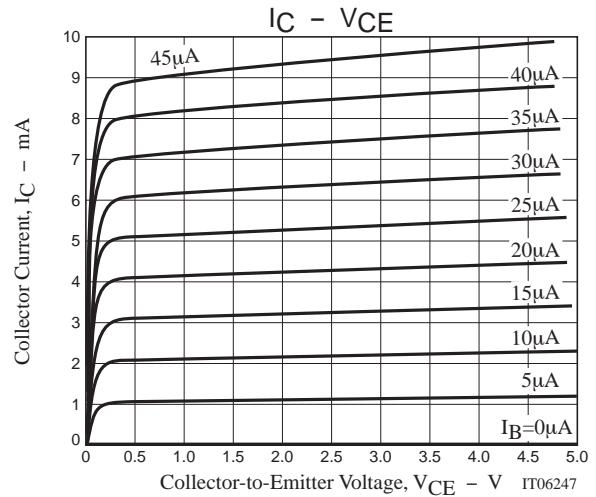
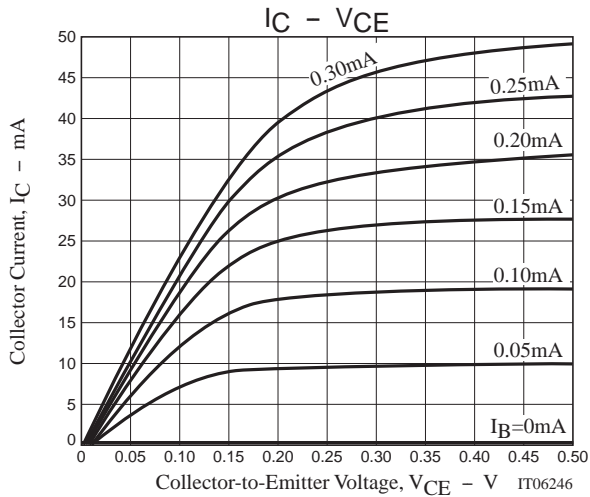

15GN01MA

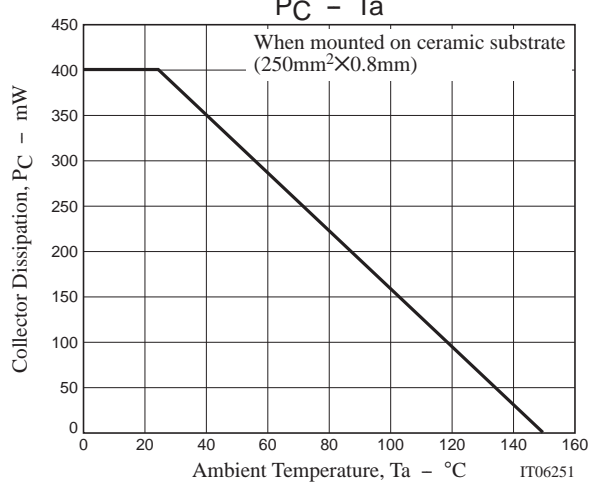
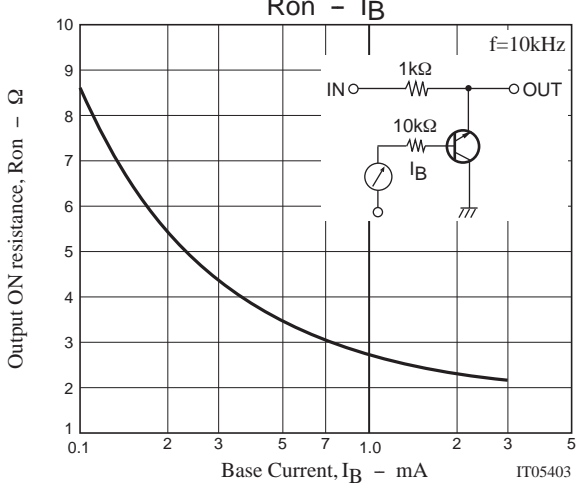
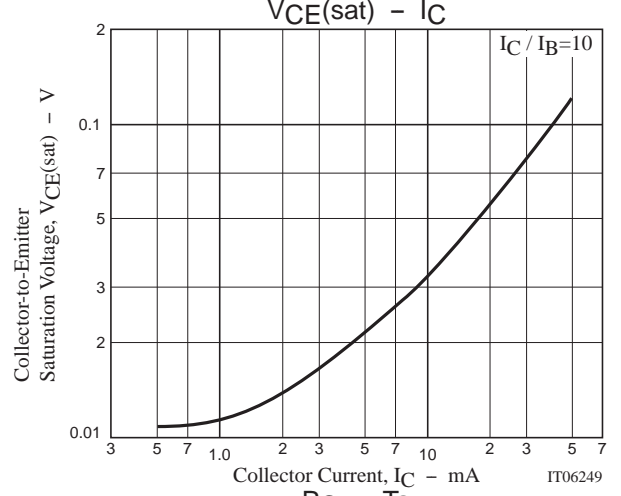
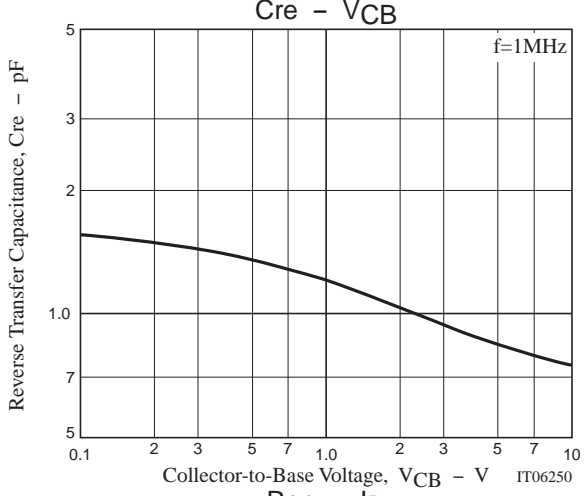
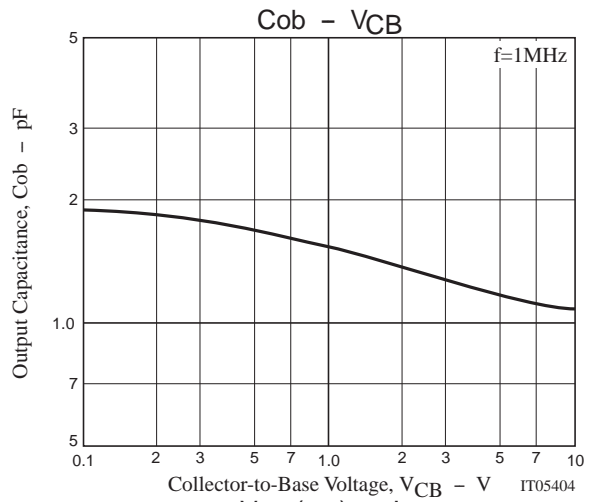
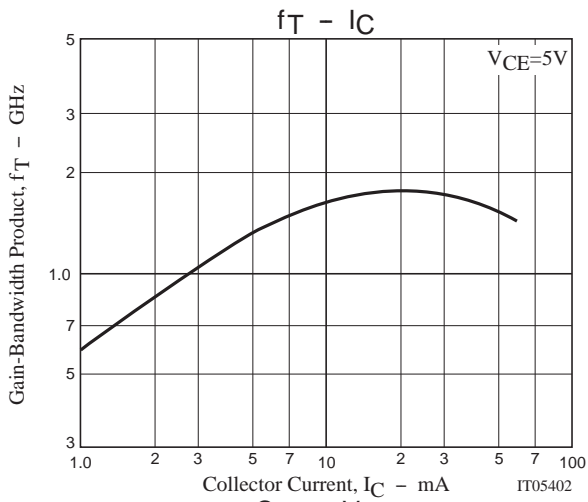

15GN01MA

S Parameters (Common emitter)

$V_{CE}=5V, I_C=5mA, Z_O=50\Omega$

Freq(MHz)	S11	$\angle S11$	S21	$\angle S21$	S12	$\angle S12$	S22	$\angle S22$
100	0.662	-25.65	4.631	122.00	0.028	71.36	0.765	-10.50
200	0.582	-36.72	3.028	112.20	0.051	68.80	0.732	-14.15
300	0.529	-47.21	2.353	104.69	0.071	65.59	0.713	-17.91
400	0.487	-56.61	1.955	97.68	0.088	63.00	0.700	-21.58
500	0.459	-65.82	1.691	91.07	0.103	60.43	0.689	-25.23
600	0.429	-74.14	1.496	85.11	0.116	57.83	0.679	-28.81
700	0.409	-82.44	1.353	79.01	0.128	56.22	0.674	-32.38
800	0.388	-89.94	1.239	73.29	0.138	54.76	0.671	-35.89
900	0.374	-96.79	1.149	67.98	0.148	53.44	0.671	-39.34
1000	0.365	-103.28	1.072	63.13	0.156	52.60	0.670	-42.75

$V_{CE}=5V, I_C=10mA, Z_O=50\Omega$

Freq(MHz)	S11	$\angle S11$	S21	$\angle S21$	S12	$\angle S12$	S22	$\angle S22$
100	0.587	-31.65	6.647	118.78	0.026	71.86	0.694	-11.96
200	0.502	-46.40	4.239	108.57	0.046	68.22	0.653	-15.76
300	0.444	-59.47	3.227	100.32	0.064	65.90	0.630	-19.10
400	0.405	-70.80	2.616	93.18	0.079	63.91	0.619	-22.50
500	0.381	-81.80	2.217	86.64	0.093	62.30	0.607	-25.83
600	0.356	-91.29	1.922	80.82	0.105	60.39	0.598	-29.19
700	0.342	-101.15	1.715	74.86	0.115	59.29	0.596	-32.72
800	0.329	-109.42	1.544	69.40	0.125	58.34	0.593	-36.10
900	0.319	-116.99	1.414	64.16	0.135	57.86	0.594	-39.48
1000	0.315	-124.06	1.305	59.41	0.144	57.47	0.593	-42.80

$V_{CE}=5V, I_C=20mA, Z_O=50\Omega$

Freq(MHz)	S11	$\angle S11$	S21	$\angle S21$	S12	$\angle S12$	S22	$\angle S22$
100	0.505	-41.07	8.945	114.82	0.023	71.42	0.611	-13.64
200	0.417	-60.49	5.500	103.75	0.042	69.03	0.568	-16.14
300	0.369	-76.83	4.039	95.20	0.056	67.39	0.548	-18.89
400	0.341	-90.31	3.197	88.11	0.070	66.22	0.539	-21.75
500	0.328	-102.08	2.654	81.71	0.082	65.43	0.533	-24.77
600	0.316	-112.57	2.264	76.38	0.094	64.49	0.528	-27.99
700	0.311	-122.49	1.988	70.80	0.104	64.03	0.530	-31.32
800	0.306	-130.50	1.771	65.75	0.115	63.95	0.530	-34.57
900	0.304	-137.80	1.605	60.92	0.125	64.09	0.534	-37.93
1000	0.306	-144.30	1.470	56.51	0.135	64.16	0.537	-41.24

15GN01MA

Embossed Taping Specification

15GN01MA-TL-E

1. Packing Format

Package Name	Carrier Tape Type	Maximum Number of devices contained (pcs)			Packing format	
		Reel	Inner box	Outer box	Inner BOX (C-1)	Outer BOX (A-7)
MCP	MCP	3,000	15,000	90,000	5 reels contained Dimensions:mm (external) 183×72×185	6 inner boxes contained Dimensions:mm (external) 440×195×210

Packing method

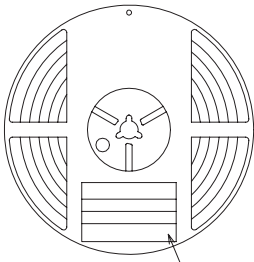

Reel label

Type No.
LOT No.
Quantity
Origin

Reel label, Inner box label
(unit: mm)

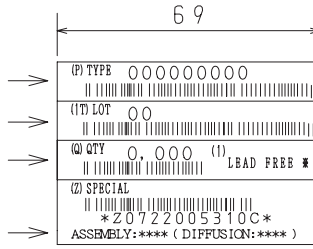

Outer box label

It is a label at the time of factory shipments.
The form of a label may change in physical distribution process.

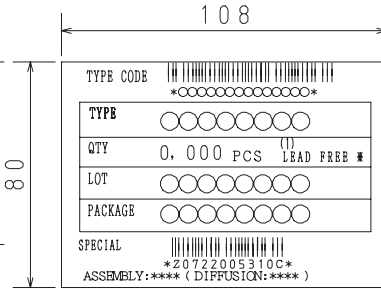

NOTE (1)

The LEAD FREE * description shows that the surface treatment of the terminal is lead free.

Label	JEITA Phase
LEAD FREE 3	JEITA Phase 3A
LEAD FREE 4	JEITA Phase 3

2. Taping configuration

2-1. Carrier tape size (unit:mm)

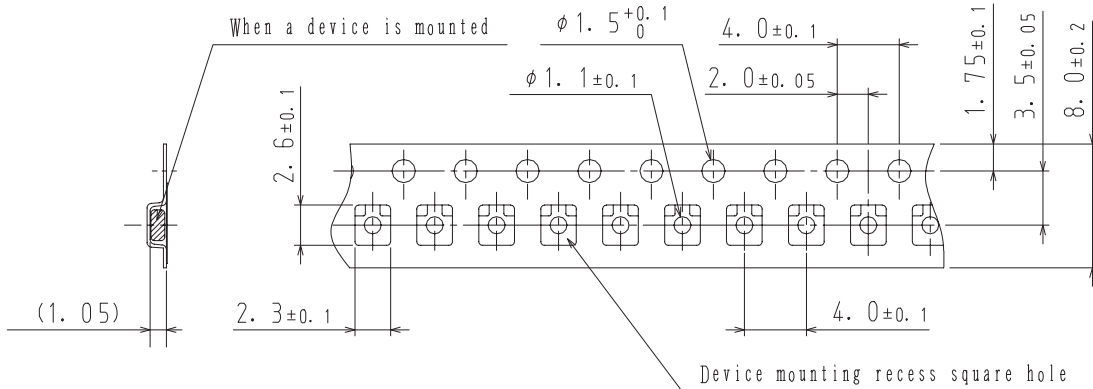

2-2. Device placement direction

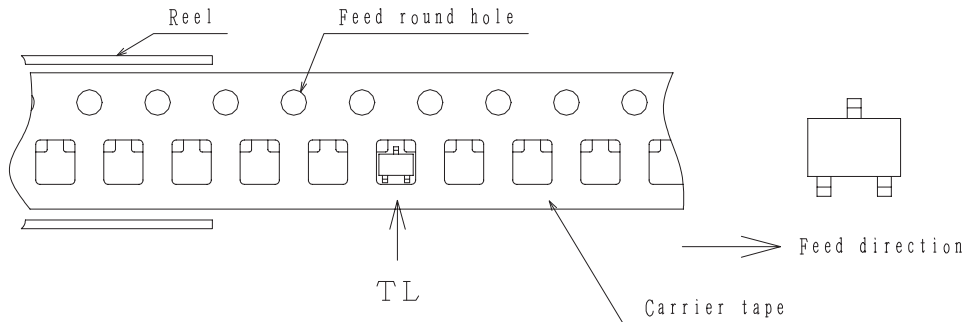

Those with one electrode terminal on the feed hole side.....TL

15GN01MA

Outline Drawing 15GN01MA-TL-E

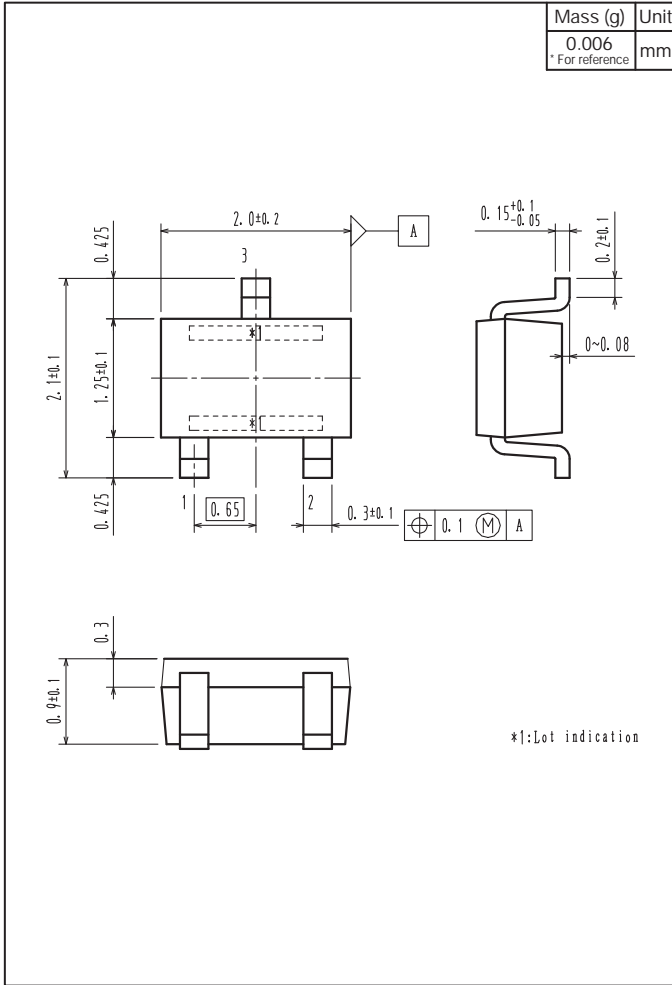

Land Pattern Example

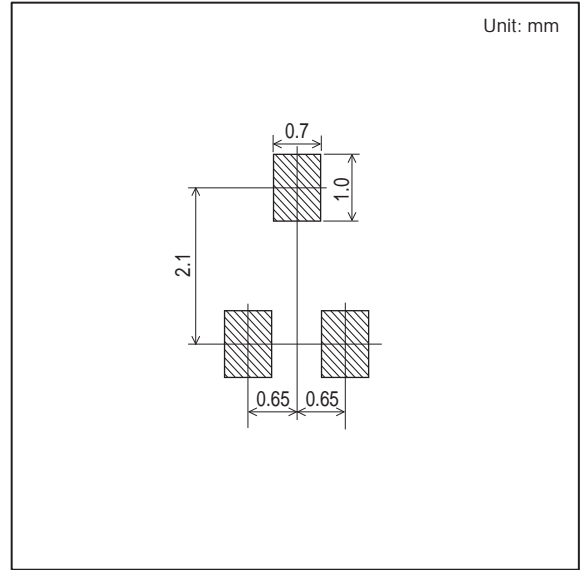

ON Semiconductor and the ON logo are registered trademarks of Semiconductor Components Industries, LLC (SCILLC). SCILLC owns the rights to a number of patents, trademarks, copyrights, trade secrets, and other intellectual property. A listing of SCILLC's product/patent coverage may be accessed at www.onsemi.com/site/pdf/Patent-Marking.pdf. SCILLC reserves the right to make changes without further notice to any products herein. SCILLC makes no warranty, representation or guarantee regarding the suitability of its products for any particular purpose, nor does SCILLC assume any liability arising out of the application or use of any product or circuit, and specifically disclaims any and all liability, including without limitation special, consequential or incidental damages. "Typical" parameters which may be provided in SCILLC data sheets and/or specifications can and do vary in different applications and actual performance may vary over time. All operating parameters, including "Typicals" must be validated for each customer application by customer's technical experts. SCILLC does not convey any license under its patent rights nor the rights of others. SCILLC products are not designed, intended, or authorized for use as components in systems intended for surgical implant into the body, or other applications intended to support or sustain life, or for any other application in which the failure of the SCILLC product could create a situation where personal injury or death may occur. Should Buyer purchase or use SCILLC products for any such unintended or unauthorized application, Buyer shall indemnify and hold SCILLC and its officers, employees, subsidiaries, affiliates, and distributors harmless against all claims, costs, damages, and expenses, and reasonable attorney fees arising out of, directly or indirectly, any claim of personal injury or death associated with such unintended or unauthorized use, even if such claim alleges that SCILLC was negligent regarding the design or manufacture of the part. SCILLC is an Equal Opportunity/Affirmative Action Employer. This literature is subject to all applicable copyright laws and is not for resale in any manner.

Mouser Electronics

Authorized Distributor

Click to View Pricing, Inventory, Delivery & Lifecycle Information:

[ON Semiconductor:](#)

[15GN01MA-TL-E](#)