

MBD101, MMBD101LT1

Preferred Device

Schottky Barrier Diodes

Designed primarily for UHF mixer applications but suitable also for use in detector and ultra-fast switching circuits. Supplied in an inexpensive plastic package for low-cost, high-volume consumer requirements. Also available in Surface Mount package.

Features

- Low Noise Figure – 6.0 dB Typ @ 1.0 GHz
- Very Low Capacitance – Less Than 1.0 pF
- High Forward Conductance – 0.5 V (Typ) @ $I_F = 10$ mA
- Pb-Free Packages are Available

MAXIMUM RATINGS

Rating	Symbol	Value	Unit
Reverse Voltage	V_R	7.0	V
Forward Power Dissipation $T_A = 25^\circ\text{C}$	P_F	280 225	mW
Derate above 25°C		2.2 1.8	mW/ $^\circ\text{C}$
Junction Temperature	T_J	+150	$^\circ\text{C}$
Storage Temperature Range	T_{stg}	-55 to +150	$^\circ\text{C}$

Stresses exceeding Maximum Ratings may damage the device. Maximum Ratings are stress ratings only. Functional operation above the Recommended Operating Conditions is not implied. Extended exposure to stresses above the Recommended Operating Conditions may affect device reliability.

ELECTRICAL CHARACTERISTICS ($T_A = 25^\circ\text{C}$ unless otherwise noted)

Characteristic	Symbol	Min	Typ	Max	Unit
Reverse Breakdown Voltage ($I_R = 10 \mu\text{A}$)	$V_{(BR)R}$	7.0	10	-	V
Diode Capacitance ($V_R = 0$, $f = 1.0$ MHz, Note 1, page 2)	C_D	-	0.88	1.0	pF
Forward Voltage ($I_F = 10$ mA)	V_F	-	0.5	0.6	V
Reverse Leakage ($V_R = 3.0$ V)	I_R	-	0.02	0.25	μA



ON Semiconductor®

<http://onsemi.com>

SILICON SCHOTTKY BARRIER DIODES

MARKING DIAGRAMS

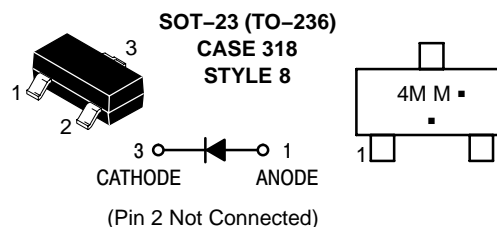
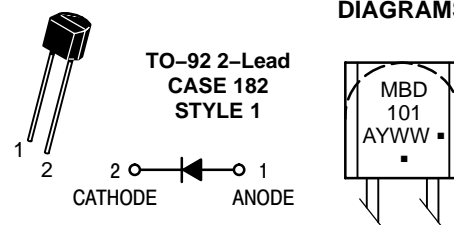

A = Assembly Location
 Y = Year
 WW = Work Week
 4M = Device Code (SOT-23)
 M = Date Code*
 ■ = Pb-Free Package
 (Note: Microdot may be in either location)
 *Date Code orientation and/or overbar may vary depending upon manufacturing location.

ORDERING INFORMATION

Device	Package	Shipping†
MBD101	TO-92	5000 Units / Box
MBD101G	TO-92 (Pb-Free)	5000 Units / Box
MMBD101LT1	SOT-23	3000 / Tape & Reel
MMBD101LT1G	SOT-23 (Pb-Free)	3000 / Tape & Reel

†For information on tape and reel specifications, including part orientation and tape sizes, please refer to our Tape and Reel Packaging Specifications Brochure, BRD8011/D.

Preferred devices are recommended choices for future use and best overall value.

MBD101, MMBD101LT1

TYPICAL CHARACTERISTICS

($T_A = 25^\circ\text{C}$ unless noted)

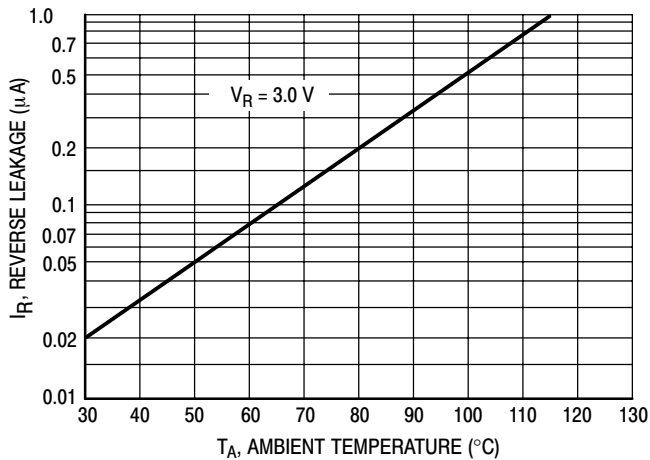

Figure 1. Reverse Leakage

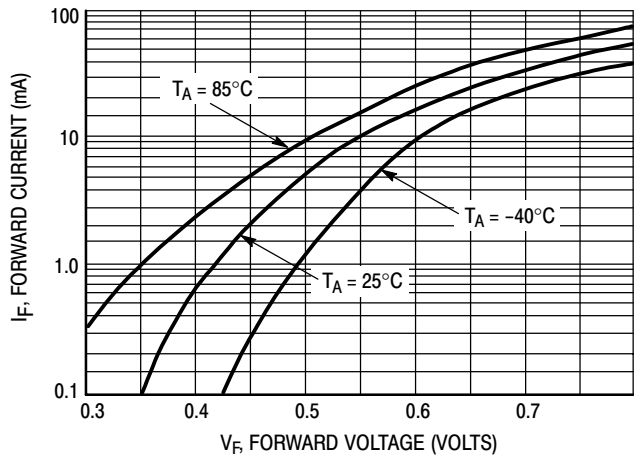

Figure 2. Forward Voltage

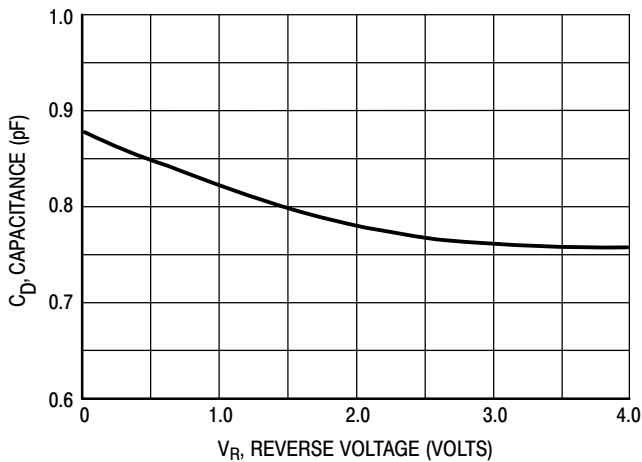

Figure 3. Capacitance

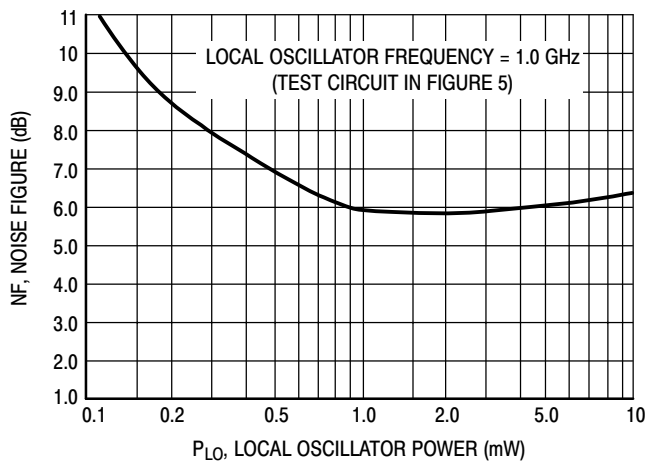

Figure 4. Noise Figure

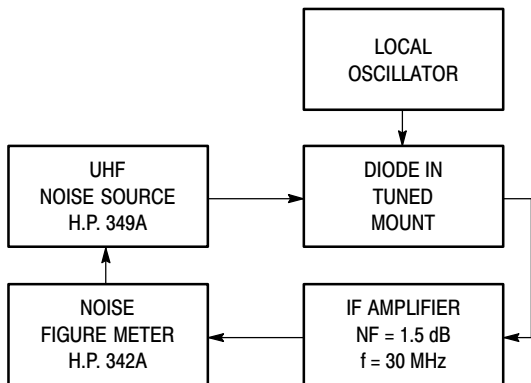

Figure 5. Noise Figure Test Circuit

NOTES ON TESTING AND SPECIFICATIONS

- Note 1 — C_D is measured using a capacitance bridge (Boonton Electronics Model 75A or equivalent).
- Note 2 — Noise figure measured with diode under test in tuned diode mount using UHF noise source and local oscillator (LO) frequency of 1.0 GHz. The LO power is adjusted for 1.0 mW. IF amplifier NF = 1.5 dB, $f = 30$ MHz, see Figure 5.
- Note 3 — L_S is measured on a package having a short instead of a die, using an impedance bridge (Boonton Radio Model 250A RX Meter).

MBD101, MMBD101LT1

PACKAGE DIMENSIONS

TO-92 TWO LEAD
 TO-226AC
 CASE 182-06
 ISSUE L

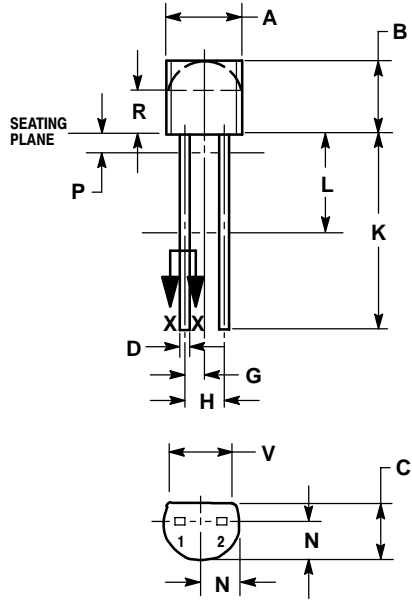

NOTES:

1. DIMENSIONING AND TOLERANCING PER ANSI Y14.5M, 1982.
2. CONTROLLING DIMENSION: INCH.
3. CONTOUR OF PACKAGE BEYOND ZONE R IS UNCONTROLLED.
4. LEAD DIMENSION IS UNCONTROLLED IN P AND BEYOND DIMENSION K MINIMUM.

DIM	INCHES		MILLIMETERS	
	MIN	MAX	MIN	MAX
A	0.175	0.205	4.45	5.21
B	0.170	0.210	4.32	5.33
C	0.125	0.165	3.18	4.19
D	0.016	0.021	0.407	0.533
G	0.050 BSC		1.27 BSC	
H	0.100 BSC		2.54 BSC	
J	0.014	0.016	0.36	0.41
K	0.500	---	12.70	---
L	0.250	---	6.35	---
N	0.080	0.105	2.03	2.66
P	---	0.050	---	1.27
R	0.115	---	2.93	---
V	0.135	---	3.43	---

STYLE 1:

- PIN 1. ANODE
- CATHODE

MBD101, MMBD101LT1

PACKAGE DIMENSIONS

SOT-23 (TO-236)
CASE 318-08
ISSUE AN

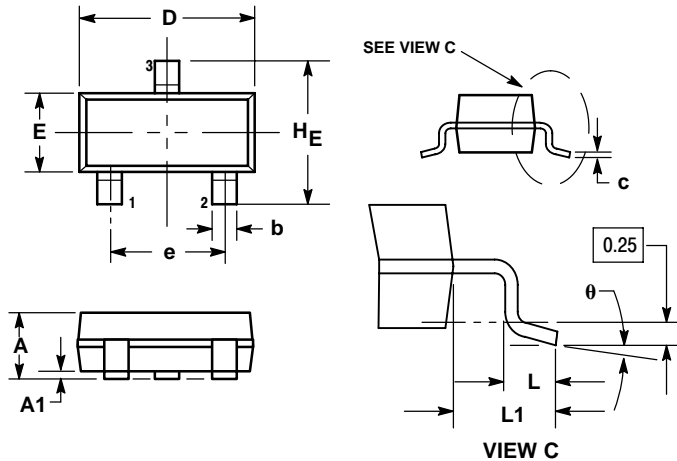

- NOTES:
1. DIMENSIONING AND TOLERANCING PER ANSI Y14.5M, 1982.
 2. CONTROLLING DIMENSION: INCH.
 3. MAXIMUM LEAD THICKNESS INCLUDES LEAD FINISH THICKNESS. MINIMUM LEAD THICKNESS IS THE MINIMUM THICKNESS OF BASE MATERIAL.
 4. 318-01 THRU -07 AND -09 OBSOLETE, NEW STANDARD 318-08.

DIM	MILLIMETERS			INCHES		
	MIN	NOM	MAX	MIN	NOM	MAX
A	0.89	1.00	1.11	0.035	0.040	0.044
A1	0.01	0.06	0.10	0.001	0.002	0.004
b	0.37	0.44	0.50	0.015	0.018	0.020
c	0.09	0.13	0.18	0.003	0.005	0.007
D	2.80	2.90	3.04	0.110	0.114	0.120
E	1.20	1.30	1.40	0.047	0.051	0.055
e	1.78	1.90	2.04	0.070	0.075	0.081
L	0.10	0.20	0.30	0.004	0.008	0.012
L1	0.35	0.54	0.69	0.014	0.021	0.029
HE	2.10	2.40	2.64	0.083	0.094	0.104

- STYLE 8:
1. ANODE
 2. NO CONNECTION
 3. CATHODE

SOLDERING FOOTPRINT*

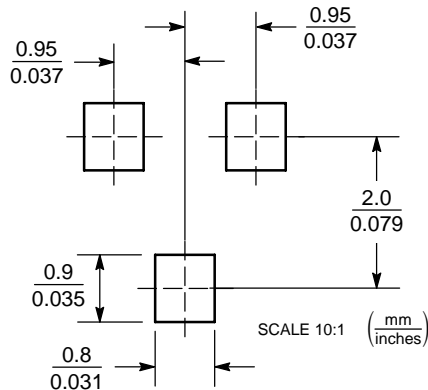

*For additional information on our Pb-Free strategy and soldering details, please download the ON Semiconductor Soldering and Mounting Techniques Reference Manual, SOLDERRM/D.

ON Semiconductor and are registered trademarks of Semiconductor Components Industries, LLC (SCILLC). SCILLC reserves the right to make changes without further notice to any products herein. SCILLC makes no warranty, representation or guarantee regarding the suitability of its products for any particular purpose, nor does SCILLC assume any liability arising out of the application or use of any product or circuit, and specifically disclaims any and all liability, including without limitation special, consequential or incidental damages. "Typical" parameters which may be provided in SCILLC data sheets and/or specifications can and do vary in different applications and actual performance may vary over time. All operating parameters, including "Typicals" must be validated for each customer application by customer's technical experts. SCILLC does not convey any license under its patent rights nor the rights of others. SCILLC products are not designed, intended, or authorized for use as components in systems intended for surgical implant into the body, or other applications intended to support or sustain life, or for any other application in which the failure of the SCILLC product could create a situation where personal injury or death may occur. Should Buyer purchase or use SCILLC products for any such unintended or unauthorized application, Buyer shall indemnify and hold SCILLC and its officers, employees, subsidiaries, affiliates, and distributors harmless against all claims, costs, damages, and expenses, and reasonable attorney fees arising out of, directly or indirectly, any claim of personal injury or death associated with such unintended or unauthorized use, even if such claim alleges that SCILLC was negligent regarding the design or manufacture of the part. SCILLC is an Equal Opportunity/Affirmative Action Employer. This literature is subject to all applicable copyright laws and is not for resale in any manner.

PUBLICATION ORDERING INFORMATION

LITERATURE FULFILLMENT:
Literature Distribution Center for ON Semiconductor
P.O. Box 5163, Denver, Colorado 80217 USA
Phone: 303-675-2175 or 800-344-3860 Toll Free USA/Canada
Fax: 303-675-2176 or 800-344-3867 Toll Free USA/Canada
Email: orderlit@onsemi.com

N. American Technical Support: 800-282-9855 Toll Free
USA/Canada
Europe, Middle East and Africa Technical Support:
Phone: 421 33 790 2910
Japan Customer Focus Center
Phone: 81-3-5773-3850

ON Semiconductor Website: www.onsemi.com

Order Literature: <http://www.onsemi.com/orderlit>

For additional information, please contact your local Sales Representative

Mouser Electronics

Authorized Distributor

Click to View Pricing, Inventory, Delivery & Lifecycle Information:

[ON Semiconductor:](#)

[MMBD101LT1G](#)