

NTMD4184PF

Power MOSFET and Schottky Diode

-30 V, -4.0 A, Single P-Channel with 20 V, 2.2 A, Schottky Barrier Diode

Features

- FETKY™ Surface Mount Package Saves Board Space
- Independent Pin-Out for MOSFET and Schottky Allowing for Design Flexibility
- Low $R_{DS(on)}$ MOSFET and Low V_F Schottky to Minimize Conduction Losses
- Optimized Gate Charge to Minimize Switching Losses
- This is a Pb-Free Device

Applications

- Disk Drives
- DC-DC Converters
- Printers

MOSFET MAXIMUM RATINGS ($T_J = 25^\circ\text{C}$ unless otherwise stated)

Rating	Symbol	Value	Unit
Drain-to-Source Voltage	V_{DSS}	-30	V
Gate-to-Source Voltage	V_{GS}	± 20	V
Continuous Drain Current $R_{\theta JA}$ (Note 1)	I_D	$T_A = 25^\circ\text{C}$	-3.3
		$T_A = 70^\circ\text{C}$	-2.6
Power Dissipation $R_{\theta JA}$ (Note 1)	P_D	1.6	W
Continuous Drain Current $R_{\theta JA}$ (Note 2)	I_D	$T_A = 25^\circ\text{C}$	-2.3
		$T_A = 70^\circ\text{C}$	-1.8
Power Dissipation $R_{\theta JA}$ (Note 2)	P_D	0.77	W
Continuous Drain Current $R_{\theta JA} t < 10$ s (Note 1)	I_D	$T_A = 25^\circ\text{C}$	-4.0
		$T_A = 70^\circ\text{C}$	-3.2
Power Dissipation $R_{\theta JA} t < 10$ s (Note 1)	P_D	2.31	W
Pulsed Drain Current	I_{DM}	-10	A
Operating Junction and Storage Temperature		T_J, T_{STG}	-55 to +150
Source Current (Body Diode)	I_S	-1.3	A
Lead Temperature for Soldering Purposes (1/8" from case for 10 s)	T_L	260	$^\circ\text{C}$

SCHOTTKY MAXIMUM RATINGS ($T_J = 25^\circ\text{C}$ unless otherwise stated)

Rating	Symbol	Value	Unit
Peak Repetitive Reverse Voltage	V_{RRM}	20	V
DC Blocking Voltage	V_R	20	V
Average Rectified Forward Current, (Note 1)	I_F	Steady State	2.2
		$t < 10$ s	3.2



ON Semiconductor®

<http://onsemi.com>

P-CHANNEL MOSFET

$V_{(BR)DSS}$	$R_{DS(on)}$ Max	I_D Max
-30 V	95 m Ω @ -10 V	-4.0 A
	165 m Ω @ -4.5 V	

SCHOTTKY DIODE

V_R Max	V_F Max	I_F Max
20 V	0.58 V	2.2 A

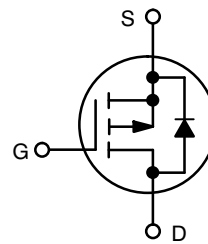

P-Channel MOSFET



Schottky Diode

MARKING DIAGRAM & PIN ASSIGNMENT

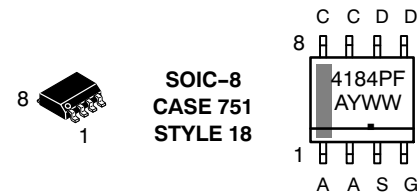

4184PF = Device Code
 A = Assembly Location
 Y = Year
 WW = Work Week
 ■ = Pb-Free Package

ORDERING INFORMATION

Device	Package	Shipping†
NTMD4184PFR2G	SOIC-8 (Pb-Free)	2500/Tape & Reel

†For information on tape and reel specifications, including part orientation and tape sizes, please refer to our Tape and Reel Packaging Specification Brochure, BRD8011/D.

NTMD4184PF

THERMAL RESISTANCE MAXIMUM RATINGS

Parameter MOSFET & Schottky	Symbol	Max	Unit
Junction-to-Ambient – Steady State (Note 1)	$R_{\theta JA}$	79	°C/W
Junction-to-Ambient – $t \leq 10$ s Steady State (Note 1)	$R_{\theta JA}$	54	
Junction-to-FOOT (Drain) Equivalent to $R_{\theta JC}$	$R_{\theta JF}$	50	
Junction-to-Ambient – Steady State (Note 2)	$R_{\theta JA}$	163	

1. Surface-mounted on FR4 board using 1 inch sq pad size, 1 oz Cu.
2. Surface-mounted on FR4 board using the minimum recommended pad size.

ELECTRICAL CHARACTERISTICS ($T_J = 25^\circ\text{C}$ unless otherwise noted)

Characteristic	Symbol	Test Condition	Min	Typ	Max	Unit
----------------	--------	----------------	-----	-----	-----	------

OFF CHARACTERISTICS

Drain-to-Source Breakdown Voltage	$V_{(BR)DSS}$	$V_{GS} = 0\text{ V}, I_D = 250\ \mu\text{A}$	-30			V
Drain-to-Source Breakdown Voltage Temperature Coefficient	$V_{(BR)DSS}/T_J$			30		mV/°C
Zero Gate Voltage Drain Current	I_{DSS}	$V_{GS} = 0\text{ V}, V_{DS} = -24\text{ V}$	$T_J = 25^\circ\text{C}$		-1.0	μA
			$T_J = 125^\circ\text{C}$		-10	
Gate-to-Source Leakage Current	I_{GSS}	$V_{DS} = 0\text{ V}, V_{GS} = \pm 20\text{ V}$			± 100	nA

ON CHARACTERISTICS (Note 3)

Gate Threshold Voltage	$V_{GS(TH)}$	$V_{GS} = V_{DS}, I_D = 250\ \mu\text{A}$	-1.0		-3.0	V
Negative Threshold Temperature Coefficient	$V_{GS(TH)}/T_J$			4.4		mV/°C
Drain-to-Source On Resistance	$R_{DS(on)}$	$V_{GS} = -10\text{ V}, I_D = -3.0\text{ A}$		70	95	m Ω
		$V_{GS} = -4.5\text{ V}, I_D = -1.5\text{ A}$		120	165	
Forward Transconductance	g_{FS}	$V_{DS} = -1.5\text{ V}, I_D = -3.0\text{ A}$		5.0		S

CHARGES, CAPACITANCES AND GATE RESISTANCE

Input Capacitance	C_{ISS}	$V_{GS} = 0\text{ V}, f = 1.0\text{ MHz}, V_{DS} = -10\text{ V}$		280	360	pF
Output Capacitance	C_{OSS}			80	110	
Reverse Transfer Capacitance	C_{RSS}			52	80	
Total Gate Charge	$Q_{G(TOT)}$	$V_{GS} = -4.5\text{ V}, V_{DS} = -10\text{ V}, I_D = -3.0\text{ A}$		2.8	4.2	nC
Threshold Gate Charge	$Q_{G(TH)}$			0.4		
Gate-to-Source Charge	Q_{GS}			1.1		
Gate-to-Drain Charge	Q_{GD}			1.1		
Total Gate Charge	$Q_{G(TOT)}$	$V_{GS} = -10\text{ V}, V_{DS} = -10\text{ V}, I_D = -3.0\text{ A}$		5.8	8.8	nC

SWITCHING CHARACTERISTICS (Note 4)

Turn-On Delay Time	$t_{d(ON)}$	$V_{GS} = -10\text{ V}, V_{DS} = -10\text{ V}, I_D = -1.0\text{ A}, R_G = 6.0\ \Omega$		7.2	15	ns
Rise Time	t_r			12	24	
Turn-Off Delay Time	$t_{d(OFF)}$			18	36	
Fall Time	t_f			2.6	6.0	

DRAIN-TO-SOURCE CHARACTERISTICS

Forward Diode Voltage	V_{SD}	$V_{GS} = 0\text{ V}, I_D = -1.3\text{ A}$	$T_J = 25^\circ\text{C}$		-0.8	-1.0	V
			$T_J = 125^\circ\text{C}$		0.7		
Reverse Recovery Time	t_{RR}	$V_{GS} = 0\text{ V}, dI_S/dt = 100\text{ A}/\mu\text{s}, I_S = -1.3\text{ A}$		12.8		ns	
Charge Time	t_a			10			
Discharge Time	t_b			2.8			
Reverse Recovery Time	Q_{RR}			7.4		nC	

NTMD4184PF

ELECTRICAL CHARACTERISTICS ($T_J = 25^\circ\text{C}$ unless otherwise noted)

Characteristic	Symbol	Test Condition	Min	Typ	Max	Unit
----------------	--------	----------------	-----	-----	-----	------

SCHOTTKY DIODE ELECTRICAL CHARACTERISTICS ($T_J = 25^\circ\text{C}$ unless otherwise noted)

Parameter	Symbol	Test Conditions	Min	Typ	Max	Unit
Maximum Instantaneous Forward Voltage	V_F	$I_F = 1.0\text{ A}$	$T_J = 25^\circ\text{C}$	0.43	0.50	V
			$T_J = 125^\circ\text{C}$	0.35	0.39	
		$I_F = 2.0\text{ A}$	$T_J = 25^\circ\text{C}$	0.5	0.58	
			$T_J = 125^\circ\text{C}$	0.45	0.53	
Maximum Instantaneous Reverse Current	I_R	$V_R = 10\text{ V}$	$T_J = 25^\circ\text{C}$	0.001	0.02	mA
			$T_J = 125^\circ\text{C}$	1.2	14	
		$V_R = 20\text{ V}$	$T_J = 25^\circ\text{C}$	0.004	0.05	
			$T_J = 125^\circ\text{C}$	2.0	18	

- Pulse Test: pulse width $\leq 300\ \mu\text{s}$, duty cycle $\leq 2\%$.
- Switching characteristics are independent of operating junction temperatures.

TYPICAL CHARACTERISTICS

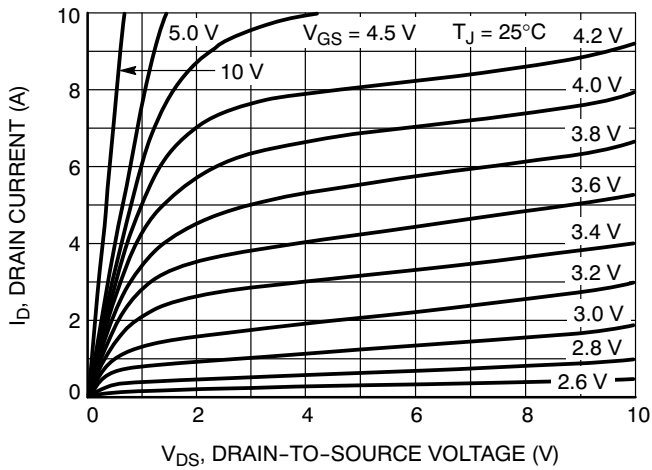

Figure 1. On-Region Characteristics

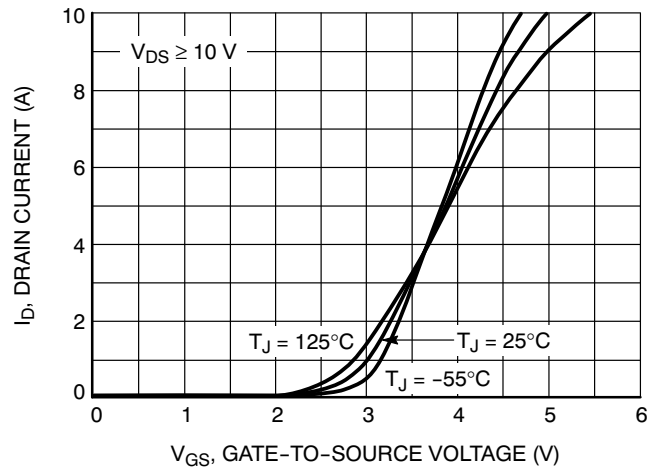

Figure 2. Transfer Characteristics

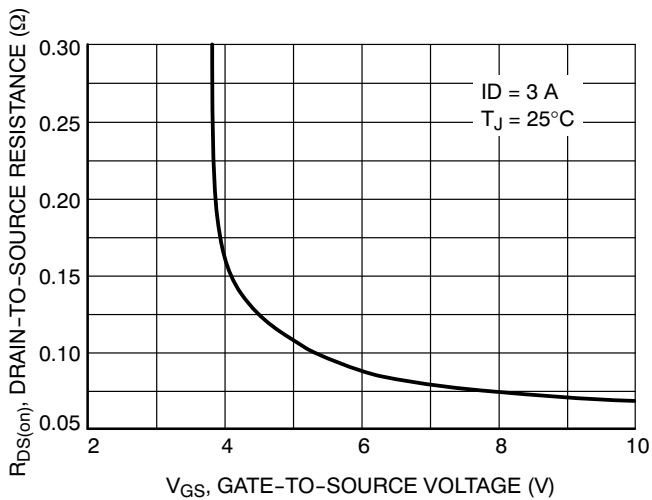

Figure 3. On-Resistance vs. Gate Voltage

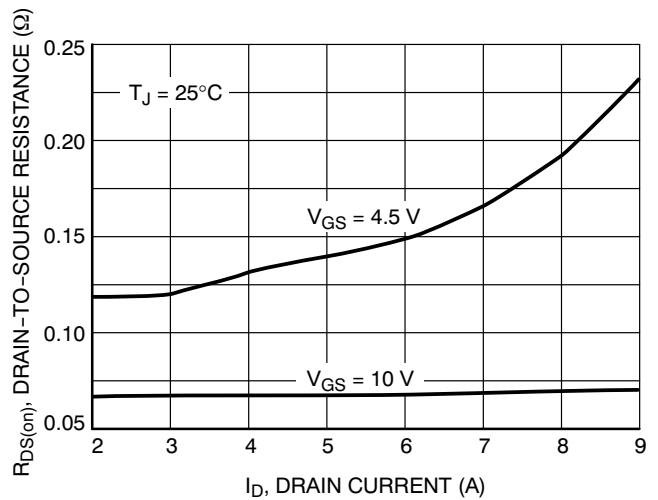

Figure 4. On-Resistance vs. Drain Current and Gate Voltage

NTMD4184PF

TYPICAL CHARACTERISTICS

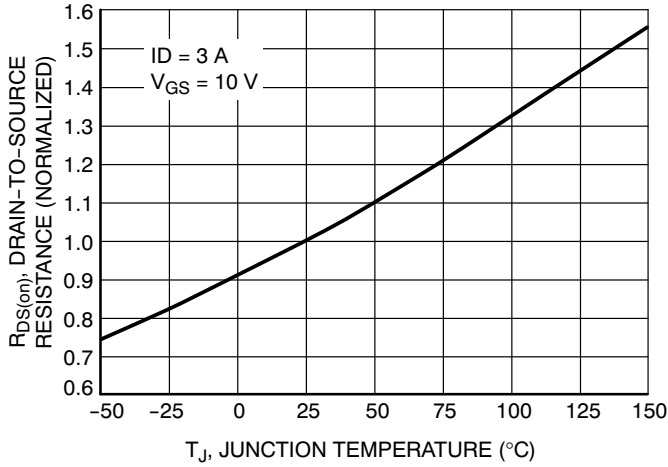

Figure 5. On-Resistance Variation with Temperature

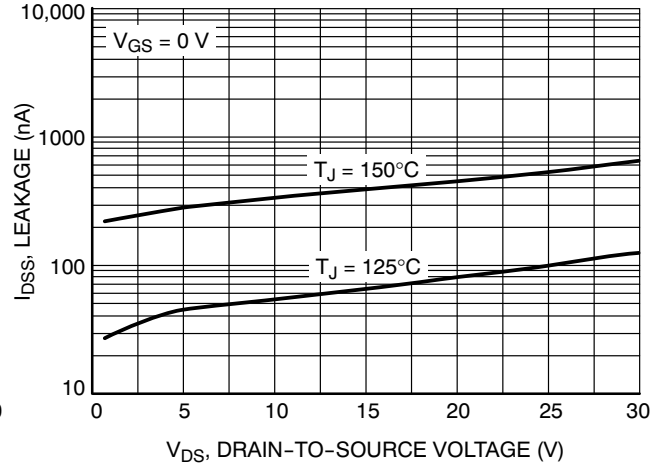

Figure 6. Drain-to-Source Leakage Current vs. Voltage

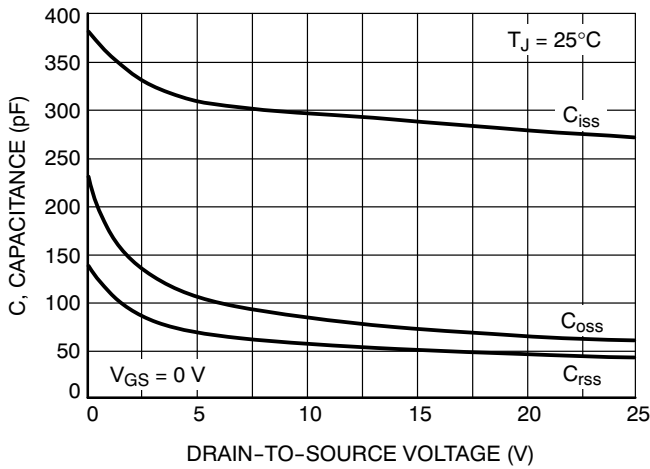

Figure 7. Capacitance Variation

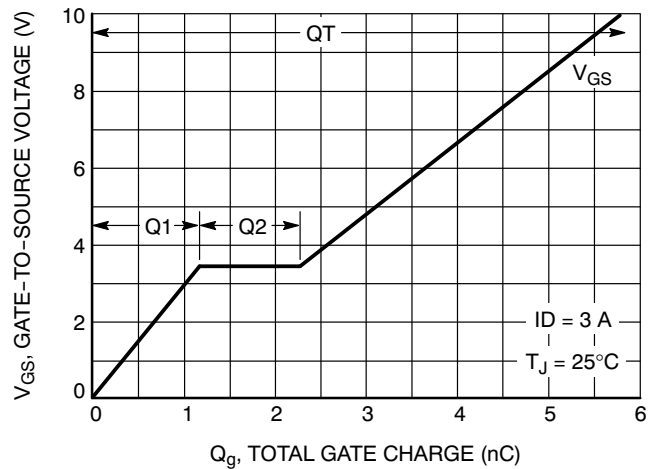

Figure 8. Gate-to-Source and Drain-to-Source Voltage vs. Total Charge

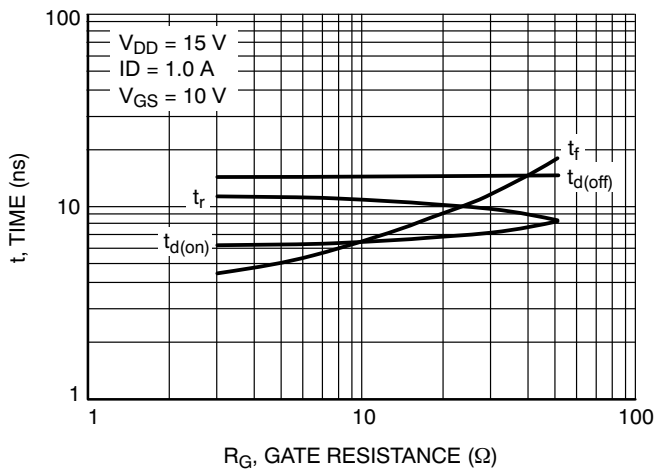

Figure 9. Resistive Switching Time Variation vs. Gate Resistance

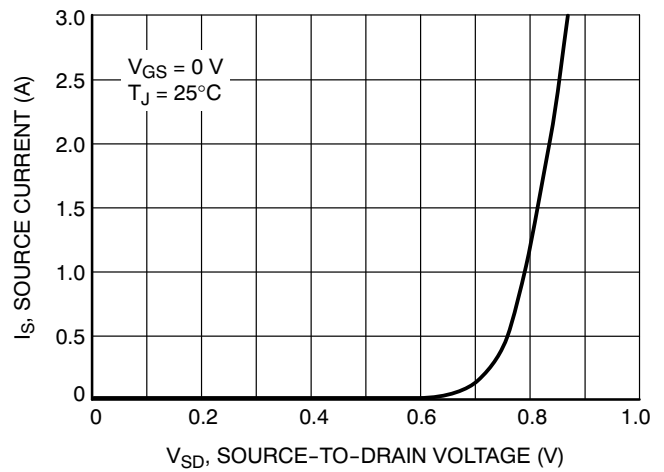

Figure 10. Diode Forward Voltage vs. Current

NTMD4184PF

TYPICAL CHARACTERISTICS

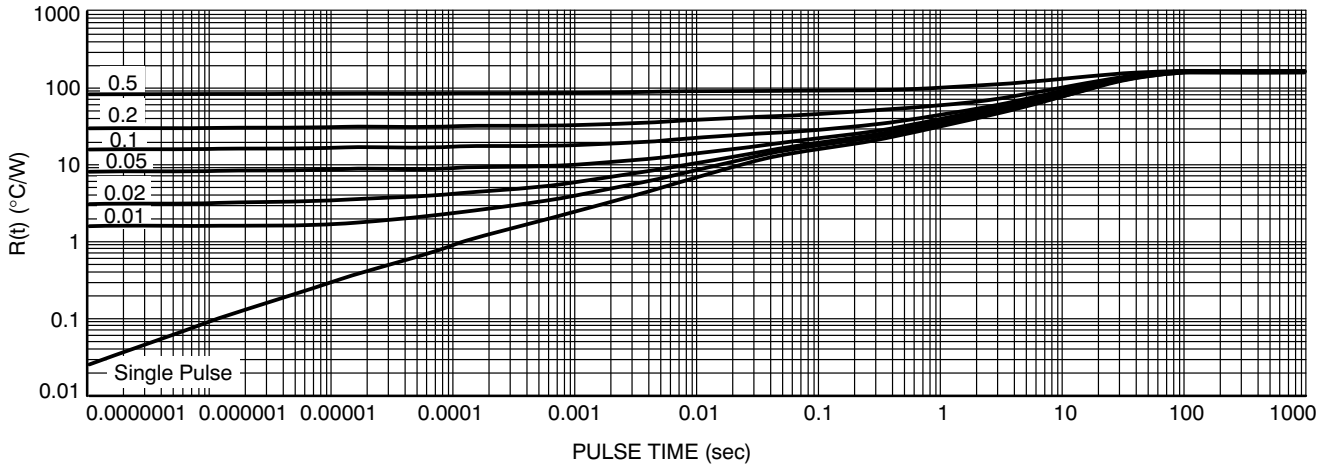

Figure 11. Thermal Response - $R_{\theta JA}$ at Steady State (min pad)

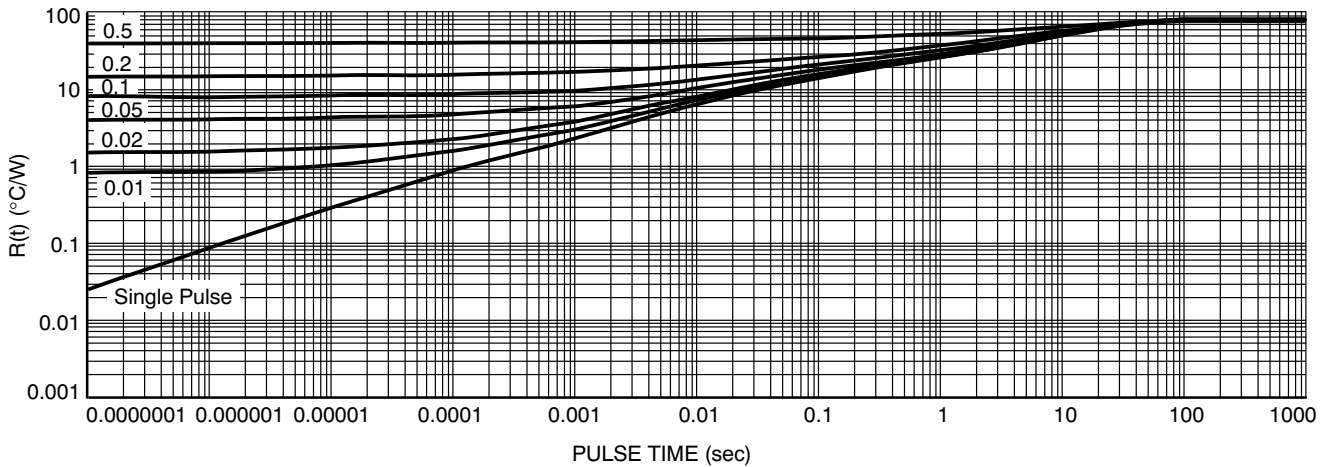

Figure 12. Thermal Response - $R_{\theta JA}$ at Steady State (1 inch sq pad)

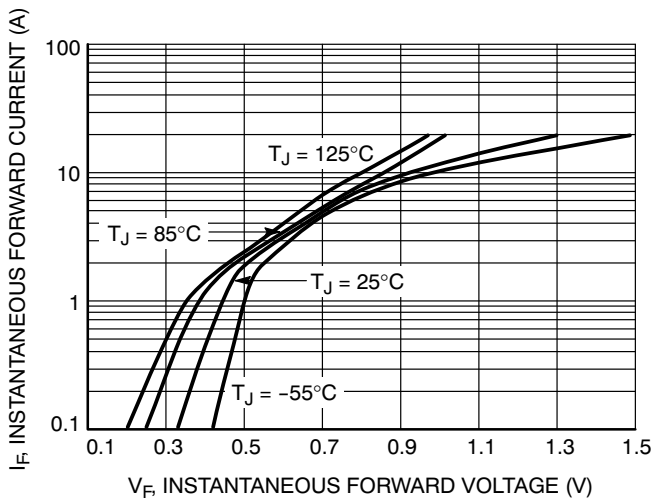

Figure 13. Typical Forward Voltage

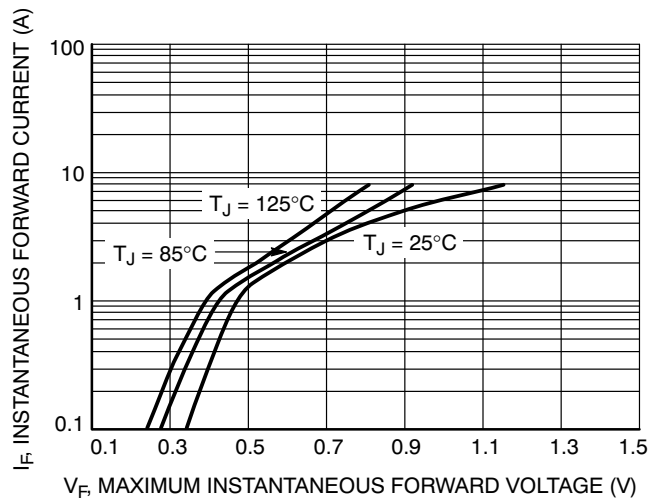

Figure 14. Maximum Forward Voltage

NTMD4184PF

TYPICAL CHARACTERISTICS

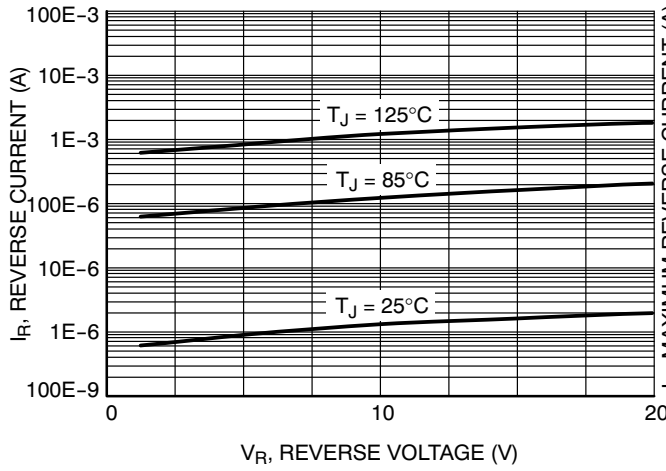

Figure 15. Typical Reverse Current

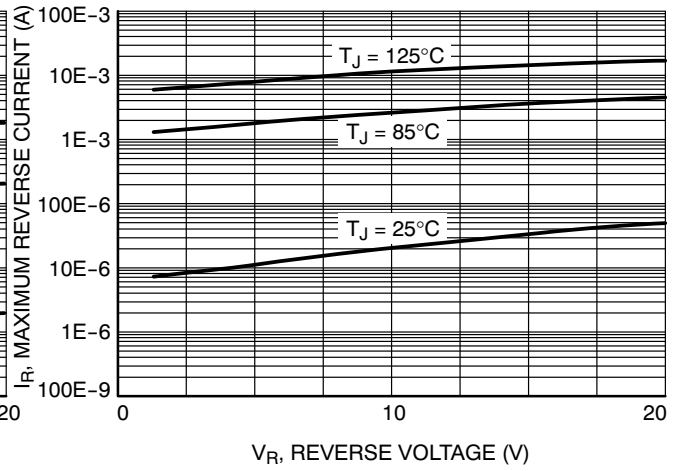

Figure 16. Maximum Reverse Current

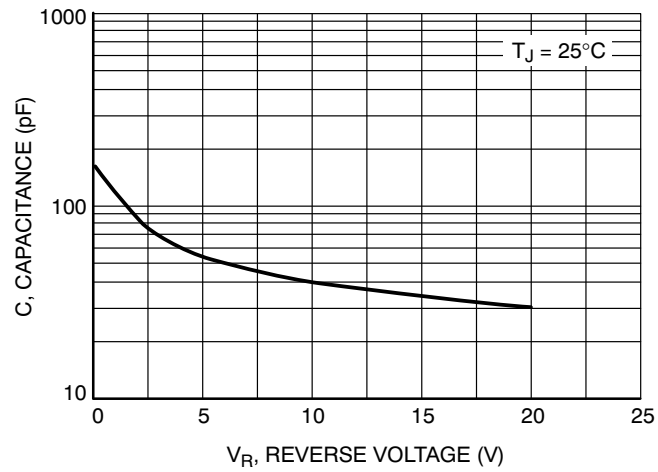
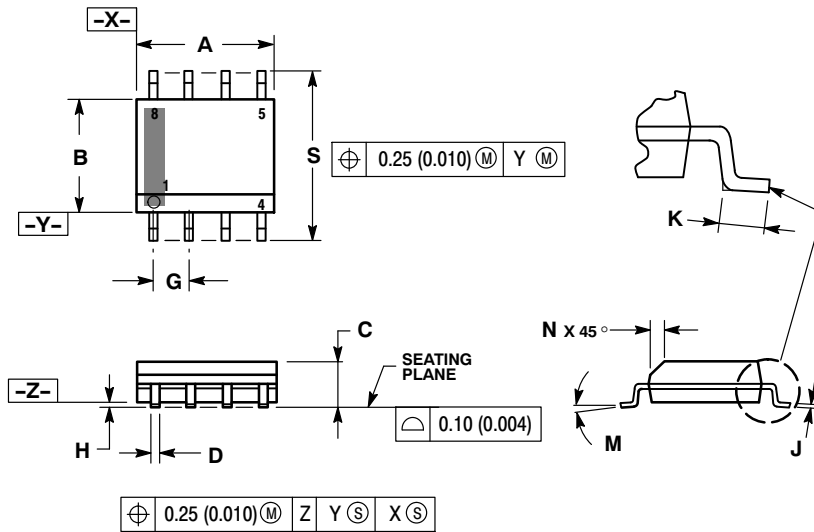

Figure 17. Capacitance

NTMD4184PF

PACKAGE DIMENSIONS

SOIC-8 NB
CASE 751-07
ISSUE AH



NOTES:

1. DIMENSIONING AND TOLERANCING PER ANSI Y14.5M, 1982.
2. CONTROLLING DIMENSION: MILLIMETER.
3. DIMENSION A AND B DO NOT INCLUDE MOLD PROTRUSION.
4. MAXIMUM MOLD PROTRUSION 0.15 (0.006) PER SIDE.
5. DIMENSION D DOES NOT INCLUDE DAMBAR PROTRUSION. ALLOWABLE DAMBAR PROTRUSION SHALL BE 0.127 (0.005) TOTAL IN EXCESS OF THE D DIMENSION AT MAXIMUM MATERIAL CONDITION.
6. 751-01 THRU 751-06 ARE OBSOLETE. NEW STANDARD IS 751-07.

DIM	MILLIMETERS		INCHES	
	MIN	MAX	MIN	MAX
A	4.80	5.00	0.189	0.197
B	3.80	4.00	0.150	0.157
C	1.35	1.75	0.053	0.069
D	0.33	0.51	0.013	0.020
G	1.27 BSC		0.050 BSC	
H	0.10	0.25	0.004	0.010
J	0.19	0.25	0.007	0.010
K	0.40	1.27	0.016	0.050
M	0°	8°	0°	8°
N	0.25	0.50	0.010	0.020
S	5.80	6.20	0.228	0.244

SOLDERING FOOTPRINT*

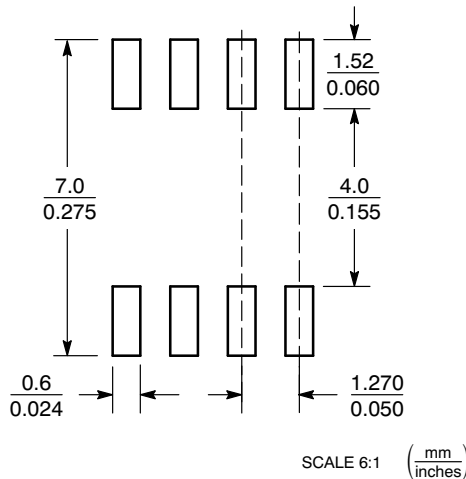

*For additional information on our Pb-Free strategy and soldering details, please download the ON Semiconductor Soldering and Mounting Techniques Reference Manual, SOLDERRM/D.

STYLE 18:

- PIN 1. ANODE
- ANODE
- SOURCE
- GATE
- DRAIN
- DRAIN
- CATHODE
- CATHODE

FETKY and Micro8 are registered trademarks of International Rectifier Corporation.

ON Semiconductor and are registered trademarks of Semiconductor Components Industries, LLC (SCILLC). SCILLC reserves the right to make changes without further notice to any products herein. SCILLC makes no warranty, representation or guarantee regarding the suitability of its products for any particular purpose, nor does SCILLC assume any liability arising out of the application or use of any product or circuit, and specifically disclaims any and all liability, including without limitation special, consequential or incidental damages. "Typical" parameters which may be provided in SCILLC data sheets and/or specifications can and do vary in different applications and actual performance may vary over time. All operating parameters, including "Typicals" must be validated for each customer application by customer's technical experts. SCILLC does not convey any license under its patent rights nor the rights of others. SCILLC products are not designed, intended, or authorized for use as components in systems intended for surgical implant into the body, or other applications intended to support or sustain life, or for any other application in which the failure of the SCILLC product could create a situation where personal injury or death may occur. Should Buyer purchase or use SCILLC products for any such unintended or unauthorized application, Buyer shall indemnify and hold SCILLC and its officers, employees, subsidiaries, affiliates, and distributors harmless against all claims, costs, damages, and expenses, and reasonable attorney fees arising out of, directly or indirectly, any claim of personal injury or death associated with such unintended or unauthorized use, even if such claim alleges that SCILLC was negligent regarding the design or manufacture of the part. SCILLC is an Equal Opportunity/Affirmative Action Employer. This literature is subject to all applicable copyright laws and is not for resale in any manner.

PUBLICATION ORDERING INFORMATION

LITERATURE FULFILLMENT:
Literature Distribution Center for ON Semiconductor
P.O. Box 5163, Denver, Colorado 80217 USA
Phone: 303-675-2175 or 800-344-3860 Toll Free USA/Canada
Fax: 303-675-2176 or 800-344-3867 Toll Free USA/Canada
Email: orderlit@onsemi.com

N. American Technical Support: 800-282-9855 Toll Free
USA/Canada

Japan: ON Semiconductor, Japan Customer Focus Center
2-9-1 Kamimeguro, Meguro-ku, Tokyo, Japan 153-0051
Phone: 81-3-5773-3850

ON Semiconductor Website: <http://onsemi.com>

Order Literature: <http://www.onsemi.com/litorder>

For additional information, please contact your local Sales Representative.

Mouser Electronics

Authorized Distributor

Click to View Pricing, Inventory, Delivery & Lifecycle Information:

[ON Semiconductor:](#)

[NTMD4184PFR2G](#)