

## 3 A Synchronous DC-DC Step down Regulator ( $V_{IN} = 6\text{ V to }30\text{ V}$ , $V_{OUT} = 0.75\text{ V to }5.5\text{ V}$ )

### FEATURES

- High-Speed Response DC-DC Step Down Regulator Circuit that employs Hysteretic Control System
- Two 25 mΩ (Typ) MOSFETs for High Efficiency at 3 A
- Skip (discontinuous) Mode for Light Load Efficiency
- Maximum Output Current : 3 A
- Input Voltage Range :  $AV_{IN} = 6\text{ V to }30\text{ V}$ ,  
 $PV_{IN} = 6\text{ V to }30\text{ V}$
- Output Voltage Range : 0.75 V to 5.5 V
- Selectable Switching Frequency  
 : 250 kHz, 750 kHz, 1250 kHz
- Adjustable Soft Start
- Low Operating and Standby Quiescent Current
- Power Good Indication for Output Over and Under Voltage
- Built-in Under Voltage Lockout (UVLO), Thermal Shut Down (TSD), Over Voltage Detection (OVD), Under Voltage Detection (UVD), Over Current Protection (OCP), Short Circuit Protection (SCP)
- 24 pin Plastic Quad Flat Non-leaded Package Heat Slug Down (QFN Type)  
 (Size : 4 mm × 4 mm × 0.7 mm, 0.5 mm pitch)

### DESCRIPTION

NN30310AA is a synchronous DC-DC Step down Regulator (1-ch) comprising of a Controller IC and two power MOSFETs and employs the hysteretic control system.

By this system, when load current changes suddenly, it responds at high speed and minimizes the changes of output voltage.

Since it is possible to use capacitors with small capacitance and it is unnecessary to add external parts for system phase compensation, this IC realizes downsizing of set and reducing in the number of external parts. Output voltage is adjustable by user. Maximum current is 3 A.

### APPLICATIONS

High Current Distributed Power Systems such as

- HDDs (Hard Disk Drives)
- SSDs (Solid State Drives)
- PCs
- Game consoles
- Servers
- Security Cameras
- Network TVs
- Home Appliances
- OA Equipment etc.

### APPLICATION CIRCUIT EXAMPLE

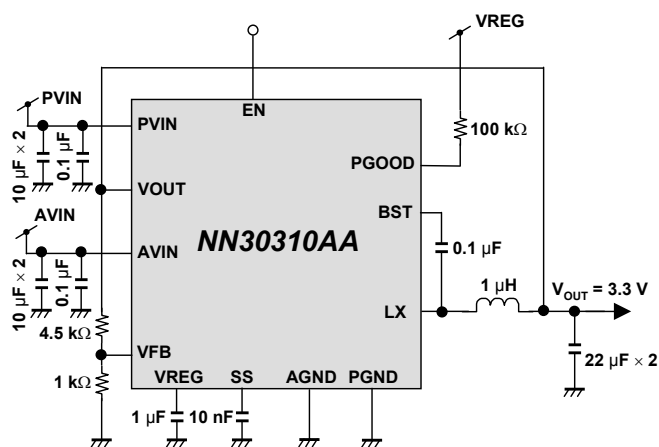

Note : The application circuit is an example. The operation of the mass production set is not guaranteed. Sufficient evaluation and verification is required in the design of the mass production set. The Customer is fully responsible for the incorporation of the above illustrated application circuit in the design of the equipment.

### EFFICIENCY CURVE

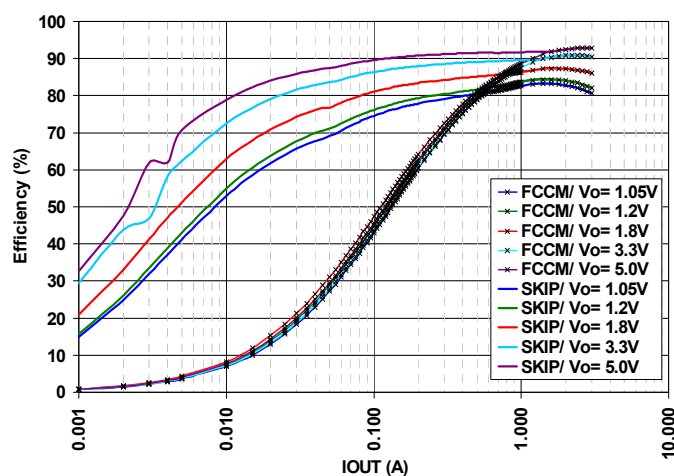

Condition :

$V_{IN} = 12\text{ V}$ ,  $V_{OUT}$  Setting = 1.05 V, 1.2 V, 1.8 V, 3.3 V, 5.0 V,  
 Switching Frequency = 750 kHz, FCCM / Skip Mode,  
 $L_O = 1\text{ }\mu\text{H}$ ,  $C_O = 44\text{ }\mu\text{F}$  (22  $\mu\text{F} \times 2$ )

**ORDERING INFORMATION**

Order Number	Feature	Package	Output Supply
NN30310AAVB	Maximum Output Current : 3 A	24 pin HQFN	Emboss Taping

**ABSOLUTE MAXIMUM RATINGS**

Parameter	Symbol	Rating	Unit	Notes
Supply voltage	$V_{IN}$	33	V	*1
Operating free-air temperature	$T_{opr}$	- 40 to + 85	°C	*2
Operating junction temperature	$T_j$	- 40 to + 150	°C	*2
Storage temperature	$T_{stg}$	- 55 to + 150	°C	*2
Input Voltage Range	$V_{MODE}, V_{FSEL}, V_{OUT}, V_{FB}$	- 0.3 to ( $V_{REG} + 0.3$ )	V	*1 *3
	$V_{EN}$	- 0.3 to 6.0	V	*1
Output Voltage Range	$V_{PGOOD}$	- 0.3 to ( $V_{REG} + 0.3$ )	V	*1 *3
	$V_{LX}$	- 0.3 to ( $V_{IN} + 0.3$ )	V	*1 *4
ESD	HBM	1.4	kV	—

Notes : This product may sustain permanent damage if subjected to conditions higher than the above stated absolute maximum rating. This rating is the maximum rating and device operating at this range is not guaranteed as it is higher than our stated recommended operating range.

When subjected under the absolute maximum rating for a long time, the reliability of the product may be affected.

$V_{IN}$  is voltage for AVIN, PVIN.  $V_{IN} = AV_{IN} = PV_{IN}$ .

Do not apply external currents and voltages to any pin not specifically mentioned.

\*1 : The values under the condition not exceeding the above absolute maximum ratings and the power dissipation.

\*2 : Except for the power dissipation, operating ambient temperature, and storage temperature, all ratings are for  $T_a = 25$  °C.

\*3 : ( $V_{REG} + 0.3$ ) V must not exceed 6 V.

\*4 : ( $V_{IN} + 0.3$ ) V must not exceed 33 V.

**POWER DISSIPATION RATING**

Package	$\theta_{j-a}$	$\theta_{j-c}$	PD (Ta = 25 °C)	PD (Ta = 85 °C)	Notes
24 pin Plastic Quad Flat Non-leaded Package Heat Slug Down (QFN Type)	61.6 °C / W	8.1 °C / W	2.029 W	1.054 W	*1
	39.0 °C / W	5.6 °C / W	3.205 W	1.666 W	*2

Notes : For the actual usage, please follow the power supply voltage, load and ambient temperature conditions to ensure that there is enough margin and the thermal design does not exceed the allowable value.

\*1:Glass Epoxy Substrate (4 Layers) [50 × 50 × 0.8 t (mm)]

\*2:Glass Epoxy Substrate (4 Layers) [50 × 50 × 1.57 t (mm)]



**CAUTION**

Although this IC has built-in ESD protection circuit, it may still sustain permanent damage if not handled properly. Therefore, proper ESD precautions are recommended to avoid electrostatic damage to the MOS gates.

**RECOMMENDED OPERATING CONDITIONS**

Parameter	Symbol	Min	Typ	Max	Unit	Notes
Supply voltage range	AV <sub>IN</sub>	6	12	30	V	—
	PV <sub>IN</sub>	6	12	30	V	—
Input Voltage Range	V <sub>MODE</sub>	-0.3	—	V <sub>REG</sub> + 0.3	V	*1
	V <sub>FSEL</sub>	-0.3	—	V <sub>REG</sub> + 0.3	V	*1
	V <sub>EN</sub>	-0.3	—	6.0	V	—
Output Voltage Range	V <sub>PGOOD</sub>	-0.3	—	V <sub>REG</sub> + 0.3	V	*1
	V <sub>LX</sub>	-0.3	—	V <sub>IN</sub> + 0.3	V	*2

Notes : Voltage values, unless otherwise specified, are with respect to GND.

GND is voltage for AGND, PGND. AGND = PGND

V<sub>IN</sub> is voltage for AVIN, PVIN. V<sub>IN</sub> = AV<sub>IN</sub> = PV<sub>IN</sub>.

Do not apply external currents or voltages to any pin not specifically mentioned.

\*1 : (V<sub>REG</sub> + 0.3) V must not exceed 6 V.

\*2 : (V<sub>IN</sub> + 0.3) V must not exceed 33 V.

**ELECTRICAL CHARACTERISTICS**

$C_O = 22 \mu\text{F} \times 2$ ,  $L_O = 1 \mu\text{H}$ ,  $V_{\text{OUT}} \text{ Setting} = 3.3 \text{ V}$ ,  $V_{\text{IN}} = AV_{\text{IN}} = PV_{\text{IN}} = 12 \text{ V}$ ,  
Switching Frequency = 750 kHz,  $V_{\text{MODE}} = V_{\text{REG}}$  (FCCM)  
 $T_a = 25 \text{ }^\circ\text{C} \pm 2 \text{ }^\circ\text{C}$  unless otherwise noted.

Parameter	Symbol	Condition	Limits			Unit	Note
			Min	Typ	Max		
<b>Current Consumption</b>							
Consumption current at active	$I_{\text{OPR}}$	$V_{\text{EN}} = 5 \text{ V}$ , $I_{\text{OUT}} = 0 \text{ A}$ $R_{\text{FB1}} = 4.5 \text{ k}\Omega$ $R_{\text{FB2}} = 1.0 \text{ k}\Omega$ $V_{\text{MODE}} = \text{GND}$ (Skip Mode)	—	650	1000	$\mu\text{A}$	—
Consumption current at standby	$I_{\text{STB}}$	$V_{\text{EN}} = 0 \text{ V}$	—	—	2	$\mu\text{A}$	—
<b>Logic Pin Characteristics</b>							
EN pin Low level input voltage	$V_{\text{ENL}}$	—	—	—	0.3	V	—
EN pin High level input voltage	$V_{\text{ENH}}$	—	1.5	—	6.0	V	—
EN pin leak current	$I_{\text{leakEN}}$	$V_{\text{EN}} = 5 \text{ V}$	—	5.0	10.0	$\mu\text{A}$	—
MODE pin Low level input voltage	$V_{\text{MDL}}$	—	—	—	$V_{\text{REG}} \times 0.3$	V	—
MODE pin High level input voltage	$V_{\text{MDH}}$	—	$V_{\text{REG}} \times 0.7$	—	$V_{\text{REG}}$	V	—
MODE pin leak current	$I_{\text{leakMD}}$	$V_{\text{MODE}} = 5 \text{ V}$	—	5.0	10.0	$\mu\text{A}$	—
FSEL pin Low level input voltage	$V_{\text{FSL}}$	—	—	—	0.3	V	—
FSEL pin High level input voltage	$V_{\text{FSH}}$	—	$V_{\text{REG}} - 0.3$	—	$V_{\text{REG}}$	V	—
FSEL pin leak current	$I_{\text{leakFS}}$	$V_{\text{FSEL}} = 5 \text{ V}$	—	15.0	25.0	$\mu\text{A}$	—
<b>VREG Characteristics</b>							
Output voltage	$V_{\text{REG}}$	$I_{\text{VREG}} = 6 \text{ mA}$	5.1	5.5	5.9	V	—
Line regulation	$V_{\text{REGLIN}}$	$V_{\text{REGLIN}} = V_{\text{REG}} (V_{\text{IN}} = 12 \text{ V})$ $- V_{\text{REG}} (V_{\text{IN}} = 6 \text{ V})$ $I_{\text{VREG}} = 6 \text{ mA}$	—	—	200	mV	—

**ELECTRICAL CHARACTERISTICS (Continued)**

$C_O = 22 \mu\text{F} \times 2$ ,  $L_O = 1 \mu\text{H}$ ,  $V_{\text{OUT}} \text{ Setting} = 3.3 \text{ V}$ ,  $V_{\text{IN}} = AV_{\text{IN}} = PV_{\text{IN}} = 12 \text{ V}$ ,  
Switching Frequency = 750 kHz,  $V_{\text{MODE}} = V_{\text{REG}}$  (FCCM)  
 $T_a = 25 \text{ }^\circ\text{C} \pm 2 \text{ }^\circ\text{C}$  unless otherwise noted.

Parameter	Symbol	Condition	Limits			Unit	Note
			Min	Typ	Max		
<b>VFB Characteristics</b>							
VFB comparator threshold	$V_{\text{FBTH}}$	—	0.594	0.600	0.606	V	—
VFB pin leak current 1	$I_{\text{leakF1}}$	$V_{\text{FB}} = 0 \text{ V}$	-1	—	1	$\mu\text{A}$	—
VFB pin leak current 2	$I_{\text{leakF2}}$	$V_{\text{FB}} = 6 \text{ V}$	-1	—	1	$\mu\text{A}$	—
<b>Under Voltage Lockout (UVLO)</b>							
UVLO detection voltage	$V_{\text{UVLODE}}$	$V_{\text{IN}} = 5 \text{ V to } 0 \text{ V}$	3.5	3.8	4.1	V	—
UVLO recover voltage	$V_{\text{UVLORE}}$	$V_{\text{IN}} = 0 \text{ V to } 5 \text{ V}$	3.9	4.2	4.5	V	—
<b>PGOOD Characteristics</b>							
PGOOD Threshold 1 ( $V_{\text{FB}}$ ratio for UVD detect)	$V_{\text{PGUV}}$	$V_{\text{PGOOD}} : \text{High to Low}$	78	85	92	%	—
PGOOD Hysteresis 1 ( $V_{\text{FB}}$ ratio for UVD release)	$\Delta V_{\text{PGUV}}$	$V_{\text{PGOOD}} : \text{Low to High}$	2	5	8	%	—
PGOOD Threshold 2 ( $V_{\text{FB}}$ ratio for OVD detect)	$V_{\text{PGOV}}$	$V_{\text{PGOOD}} : \text{High to Low}$	108	115	122	%	—
PGOOD Hysteresis 2 ( $V_{\text{FB}}$ ratio for OVD release)	$\Delta V_{\text{PGOV}}$	$V_{\text{PGOOD}} : \text{Low to High}$	2	5	8	%	—
PGOOD ON resistance	$R_{\text{PGOOD}}$	—	—	8	12	$\Omega$	—

**ELECTRICAL CHARACTERISTICS (Continued)**

$C_O = 22 \mu\text{F} \times 2$ ,  $L_O = 1 \mu\text{H}$ ,  $V_{OUT}$  Setting = 3.3 V,  $V_{IN} = AV_{IN} = PV_{IN} = 12 \text{ V}$ ,  
Switching Frequency = 750 kHz,  $V_{MODE} = V_{REG}$  (FCCM)  
 $T_a = 25 \text{ }^\circ\text{C} \pm 2 \text{ }^\circ\text{C}$  unless otherwise noted.

Parameter	Symbol	Condition	Limits			Unit	Note
			Min	Typ	Max		
<b>DC-DC Characteristics</b>							
Line regulation	$V_{LIN}$	$V_{IN} = 6 \text{ V to } 30 \text{ V}$ $I_{OUT} = 0.5 \text{ A}$	—	0.25	0.75	%/V	—
Load regulation	$V_{LOA}$	$I_{OUT} = 10 \text{ mA to } 3 \text{ A}$	—	3.5	—	%	*1
Output ripple voltage 1	$V_{R1}$	$I_{OUT} = 10 \text{ mA}$	—	20	—	mV [p-p]	*1
Output ripple voltage 2	$V_{R2}$	$I_{OUT} = 3 \text{ A}$	—	20	—	mV [p-p]	*1
Load transient response 1	$\Delta V_{TR1}$	$I_{OUT} = 100 \text{ mA to } 1.5 \text{ A}$ $V_{OUT}$ Setting = 1 V $\Delta t = 0.5 \text{ A} / \mu\text{s}$	—	20	—	mV	*1
Load transient response 2	$\Delta V_{TR2}$	$I_{OUT} = 1.5 \text{ A to } 100 \text{ mA}$ $V_{OUT}$ Setting = 1 V $\Delta t = 0.5 \text{ A} / \mu\text{s}$	—	20	—	mV	*1
High Side Power MOSFET ON resistance	$R_{ONH}$	$V_{GS} = 5.5 \text{ V}$	—	25	50	m $\Omega$	—
Low Side Power MOSFET ON resistance	$R_{ONL}$	$V_{GS} = 5.5 \text{ V}$	—	25	50	m $\Omega$	—
MIN input and output voltage difference	$V_{diff}$	$V_{diff} = V_{IN} - V_{OUT}$	—	2.5	—	V	*1

Note : \*1 : Typical design value

**ELECTRICAL CHARACTERISTICS (Continued)**

$C_O = 22 \mu\text{F} \times 2$ ,  $L_O = 1 \mu\text{H}$ ,  $V_{OUT}$  Setting = 3.3 V,  $V_{IN} = AV_{IN} = PV_{IN} = 12 \text{ V}$ ,  
Switching Frequency = 750 kHz,  $V_{MODE} = V_{REG}$  (FCCM)  
 $T_a = 25 \text{ }^\circ\text{C} \pm 2 \text{ }^\circ\text{C}$  unless otherwise noted.

Parameter	Symbol	Condition	Limits			Unit	Note
			Min	Typ	Max		
<b>Protection</b>							
DC-DC Over Current Protection Limit	$I_{LMT}$	$V_{OUT}$ Setting = 1 V	—	4.7	—	A	*1
DC-DC Short Circuit Protection Threshold	$I_{short}$	$V_{FB} = 0.6 \text{ V to } 0.0 \text{ V}$	50	60	70	%	—
Thermal Shut Down (TSD) Threshold	$T_{TSDTH}$	—	—	140	—	$^\circ\text{C}$	*1
Thermal Shut Down (TSD) Hysteresis	$T_{TSDHYS}$	—	—	20	—	$^\circ\text{C}$	*1
<b>Soft Start Timing</b>							
SS Charge Current	$I_{SSCH}$	$V_{SS} = 0.3 \text{ V}$	—	2	4	$\mu\text{A}$	—
SS Discharge Resistance (Shut down)	$R_{SSDCH}$	$V_{EN} = 0 \text{ V}$	—	5	10	$\text{k}\Omega$	—
<b>Switching Frequency</b>							
DC-DC Switching Frequency 1	$f_{SW1}$	$V_{OUT}$ Setting = 0.75 V $I_{OUT} = 3 \text{ A}$	—	250	—	kHz	*1
DC-DC Switching Frequency 2	$f_{SW2}$	$V_{OUT}$ Setting = 0.75 V $I_{OUT} = 3 \text{ A}$	—	750	—	kHz	*1
DC-DC Switching Frequency 3	$f_{SW3}$	$V_{OUT}$ Setting = 0.75 V $I_{OUT} = 3 \text{ A}$	—	1250	—	kHz	*1

Note : \*1 : Typical design value

**PIN CONFIGURATION**

Top View

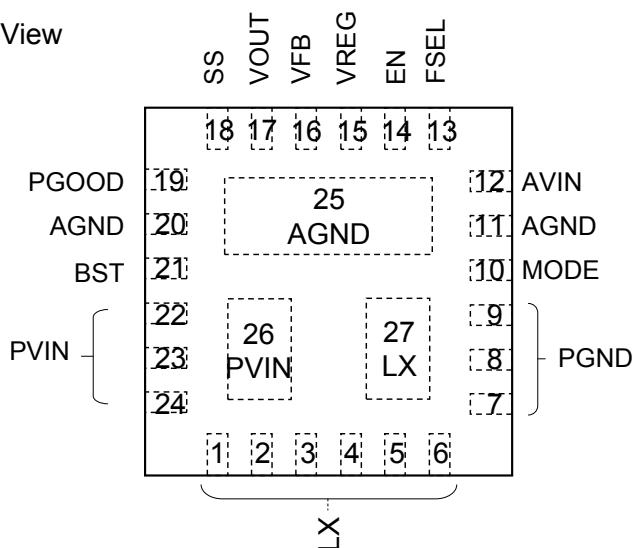

**PIN FUNCTIONS**

Pin No.	Pin name	Type	Description
1	LX	Output	Power MOSFET output pin
2			An inductor is connected and switching operation is carried out between $V_{IN}$ and GND.
3			Due to high current and large amplitude at this terminal, the parasitic inductance and impedance of the routing path can cause an increase in noise and a degradation in the efficiency.
4			Routing path should be kept as short as possible.
5			
6			
7	PGND	Ground	Ground pin for Power MOSFET
8			
9			
10	MODE	Input	Skip (discontinuous) Mode / FCCM (Forced Continuous Conduction Mode ) select pin Skip Mode is set at Low level input, FCCM is set at High level input.
11	AGND	Ground	Ground pin
20			
12	AVIN	Power supply	Power supply pin Recommended rise time ( time to reach 90 % of set value ) setting is greater than or equal to 10 $\mu$ s and less than or equal to 1 s.
13	FSEL	Input	Frequency selection pin This is set to 1250 kHz at Low level input, 250 kHz at High level input, and 750 kHz at open.
14	EN	Input	ON / OFF control pin DC-DC is stopped at Low level input, and it is started at High level input.

Note : Detailed pin descriptions are provided in the OPERATION and APPLICATION INFORMATION section.



**PIN FUNCTIONS (Continued)**

Pin No.	Pin name	Type	Description
15	VREG	Output	LDO output pin This is Output pin of Power supply (LDO) for internal control circuit. Please connect capacitor between VREG and GND.
16	VFB	Input	Comparator negative input pin VFB terminal voltage is regulated to REF output (internal reference voltage). Since VFB is a high impedance terminal, it should not be routed near other noisy path (LX, BST, etc.) or an inductor Routing path should be kept as short as possible.
17	VOUT	Input	Output voltage sense pin Switching frequency is controlled by monitoring output voltage.
18	SS	Output	Soft start capacitor connect pin The output voltage at a start up is smoothly controlled by adjusting Soft Start time. Please connect capacitor between SS and GND.
19	PGOOD	Output	Power good open drain pin A pull up resistor between PGOOD and VREG terminal is necessary. Output is low during Over or Under Voltage Detection conditions.
21	BST	Output	High side Power MOSFET gate driver pin Bootstrap operation is carried out in order to drive the gate voltage of High side Power MOSFET. Please connect a capacitor between BST and LX. Routing path should be kept as short as possible to minimize noise.
22	PVIN	Power supply	Power supply pin for Power MOSFET Recommended rise time ( time to reach 90 % of set value ) setting is greater than or equal to 10 $\mu$ s and less than or equal to 1 s.
23			
24			
25	AGND	Ground	Ground pin for heat radiation
26	PVIN	Power supply	Power supply pin for heat radiation
27	LX	Output	Power MOSFET output pin for heat radiation

Note : Detailed pin descriptions are provided in the OPERATION and APPLICATION INFORMATION section.

**FUNCTIONAL BLOCK DIAGRAM**

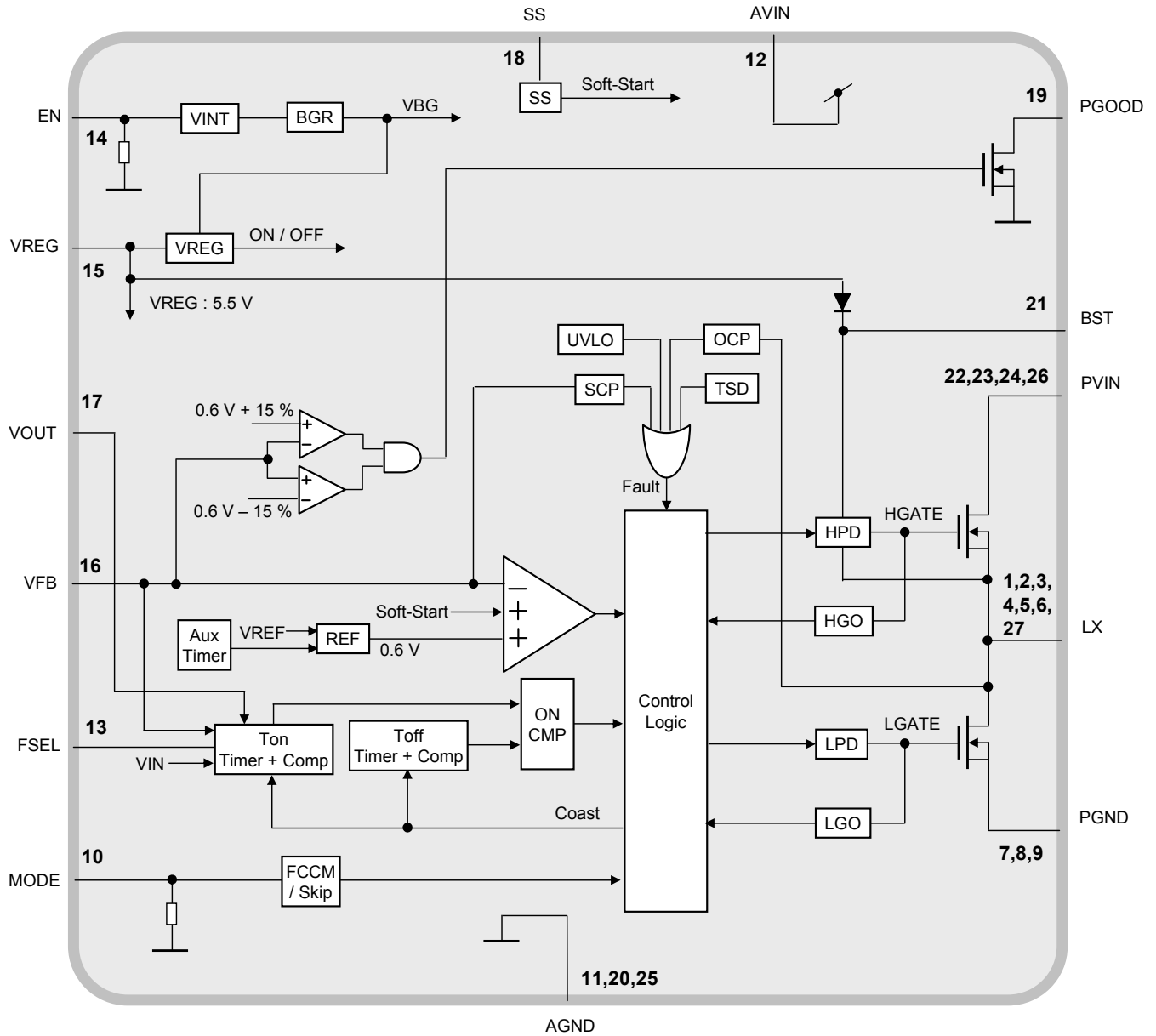

Note : This block diagram is for explaining functions. Part of the block diagram may be omitted, or it may be simplified.

**OPERATION**

1. Protection

(1) Over Current Protection (OCP) and Short Circuit Protection (SCP)

- 1) The Over Current Protection is activated at 4.7 A (Typ). During the OCP, the output voltage continues to drop at the specified current.
- 2) The Short Circuit Protection is implemented when the output voltage decreases and the VFB pin reaches to 60 % of the set voltage of 0.6 V.
- 3) The SCP operates intermittently at 2 ms ON, 16 ms OFF intervals.

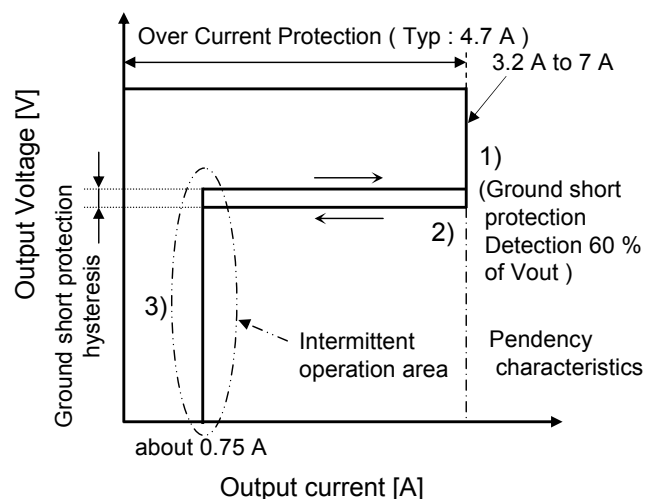

Figure : OCP and SCP Operation

(2) Over Voltage Detection (OVD) and Under Voltage Detection (UVD)

- 1) The MOSFET connected to the PGOOD pin turns ON when the output voltage rises and the VFB pin voltage reaches 115 % of its set voltage (0.6 V).
- 2) After (1) above, the MOSFET connected to the PGOOD pin is turned OFF after 1 ms when the output voltage drops and the VFB pin voltage reaches 110 % of its set voltage (0.6 V).
- 3) The MOSFET connected to the PGOOD pin turns ON when the output voltage drops and the VFB pin voltage reaches 85 % of its set voltage (0.6 V).
- 4) After (3) above, the MOSFET connected to the PGOOD pin is turned OFF after 1 ms when the output voltage drops and the VFB pin voltage reaches 90 % of its set voltage (0.6 V).

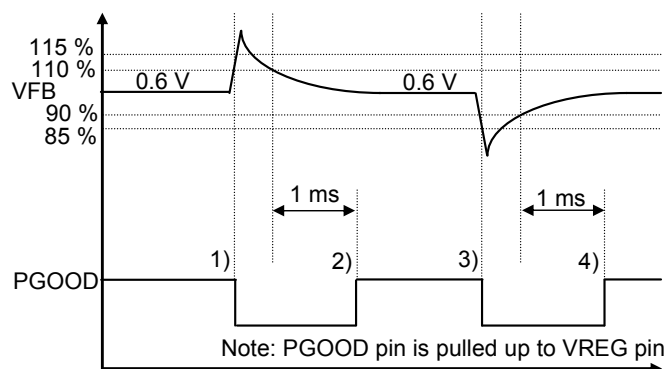

Figure : OVD and UVD Operation

(3) Thermal Shut Down (TSD)

When the IC internal temperature becomes more than about 140 °C, TSD operates and DC-DC turns off.

**OPERATION (Continued)**

**2. Pin Setting**

(1) Operating Mode Setting

The IC can operate at two different modes :  
 Skip (discontinuous) Mode and  
 Forced Continuous Conduction Mode (FCCM).  
 In Skip Mode, the IC is working under pulse skipping  
 mechanism to improve efficiency at light load condition.  
 In FCCM mode, the IC is working at fixed frequency to  
 avoid EMI issues.  
 The Operating Mode can be set by MODE pin as follows.

MODE pin	Mode
Low	Skip Mode
High	FCCM

(2) Switching Frequency Setting

The IC can operate at three different frequency :  
 1250 kHz, 750 kHz and 250 kHz.  
 The Switching Frequency can be set by FSEL pin  
 as follows.

FSEL pin	Frequency [kHz]
Low	1250
High	250
Open	750

**3. Output Voltage Setting**

The Output Voltage can be set by external resistance  
 of VFB pin, and its calculation is as follows.  
 ( $V_{IN} = 12\text{ V}$ ,  $I_{OUT} = 0\text{ A}$ , FCCM,  
 Switching Frequency = 750 kHz)

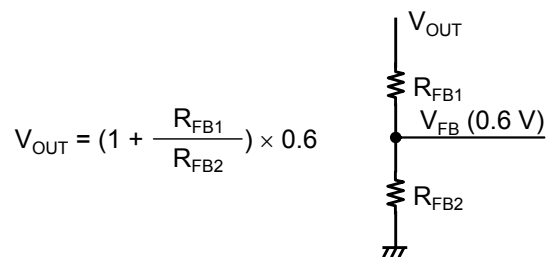

Below resistors are recommended for following popular  
 output voltage.

$V_{OUT}$ [V]	$R_{FB1}$ [ $\Omega$ ]	$R_{FB2}$ [ $\Omega$ ]
5.0	11.0 k	1.5 k
3.3	4.5 k	1.0 k
1.8	2.0 k	1.0 k
1.0	1.0 k	1.5 k

Note :  $R_{FB2}$  can be set to a maximum value of 10 k $\Omega$ .  
 A larger  $R_{FB2}$  value will be more susceptible to noise.

VFB comparator threshold is adjusted to  $\pm 1\%$ , but  
 The actual output voltage accuracy becomes more  
 than  $\pm 1\%$  due to the influence from the circuits other  
 than VFB comparator.

In the case of  $V_{OUT}$  setting = 3.3 V, the actual output  
 voltage accuracy becomes  $\pm 2.5\%$ .  
 (FCCM,  $V_{IN} = 12\text{ V}$ ,  $I_{OUT} = 0\text{ A}$ , Switching Frequency  
 = 750 kHz)

**OPERATION (Continued)**

**4. Soft Start Setting**

Soft Start function maintains the smooth control of the output voltage during start up by adjusting soft start time. When the EN pin becomes High, the current (2 μA) begin to charge toward the external capacitor (C<sub>SS</sub>) of SS pin, and the voltage of SS pin increases straightly. Because the voltage of VFB pin is controlled by the voltage of SS pin during start up, the voltage of VFB increase straightly to the regulation voltage (0.6 V) together with the voltage of SS pin and keep the regulation voltage after that. On the other hand, the voltage of SS pin increase to about 2.8 V and keep the voltage. The calculation of Soft Start Time is as follows.

$$\text{Soft Start Setting [s]} = \frac{0.6}{2\mu} \times C_{SS}$$

C<sub>SS</sub> : External capacitor value of SS pin

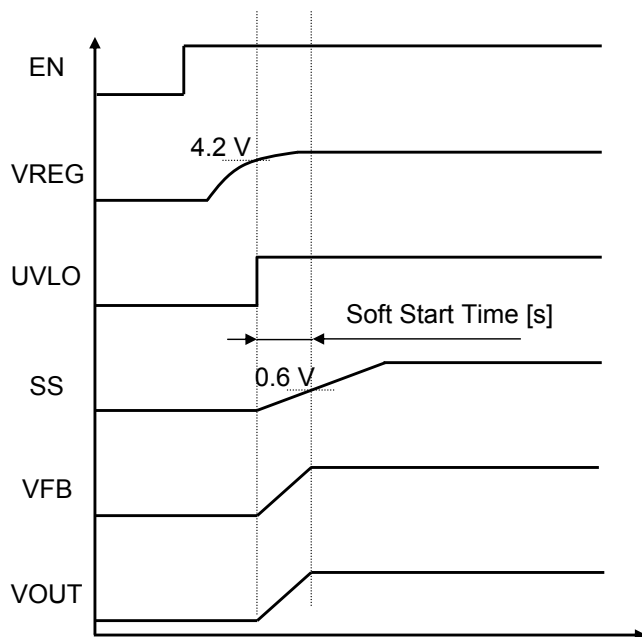

Figure : Soft Start Operation

**5. Start-up / Shut-down Settings**

The Start-up / Shut-down is enabled by the EN pin. The EN pin can be set by applying voltage from an external voltage source.

Case : Setting up the EN pin using an external voltage source. When an external voltage source is used, the EN pin input voltage (V<sub>ENH</sub>, V<sub>ENL</sub>) should satisfy the conditions as defined in the electrical characteristics

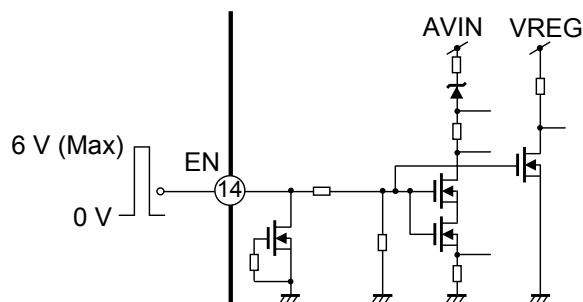

Figure : Internal circuit with EN pin

**OPERATION (Continued)**

6. Power ON / OFF Sequence

- (1) When the EN pin is set to High after the  $V_{IN}$  settles, the BGR and the VREG start up. (Recommended  $V_{IN}$  rise time setting is greater than or equal to 10  $\mu$ s and less than or equal to 1 s.)
- (2) When the VREG pin exceeds its threshold value, the UVLO is released and the Soft Start Sequence is enabled.  
 The capacitor connected to the SS pin begins to charge and the SS pin voltage increases linearly.
- (3) The VOUT pin (DC-DC Output) voltage increases at the same rate as the SS pin.  
 Normal operation begins after the VOUT pin reaches the set voltage.
- (4) When the EN pin is set to Low, the BGR, VREG and UVLO stop operation. The VOUT pin / SS pin Voltage starts to drop and the VOUT pin discharge time depends on the value of the Feedback resistors and the output load current.

Note : The SS pin capacitor should be discharged completely before restarting the startup sequence.  
 An incomplete discharge process might result in an overshoot of the output voltage.

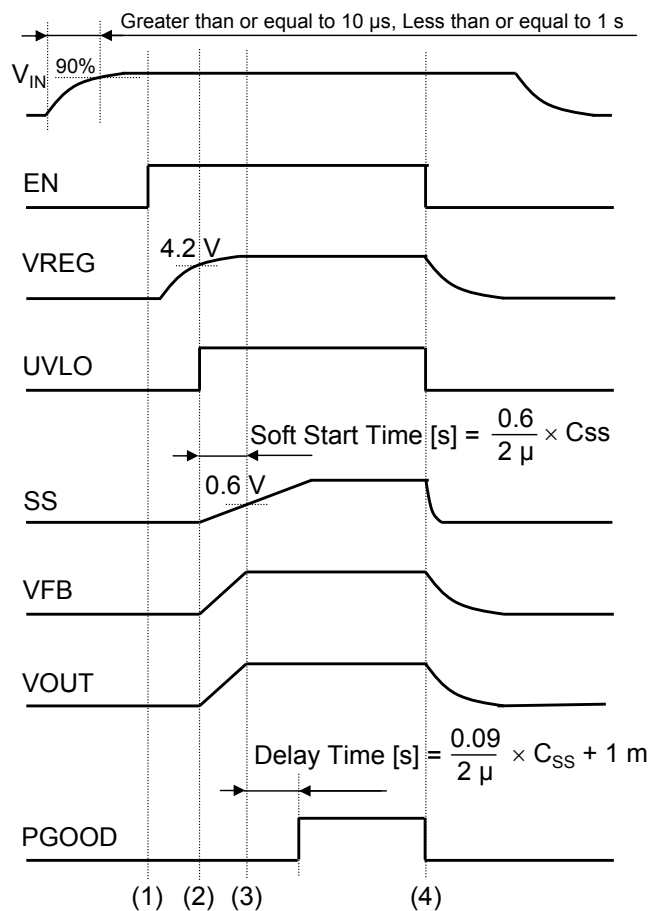
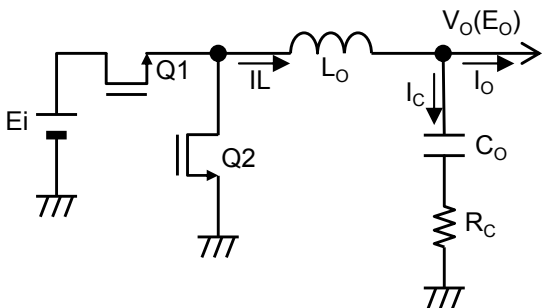
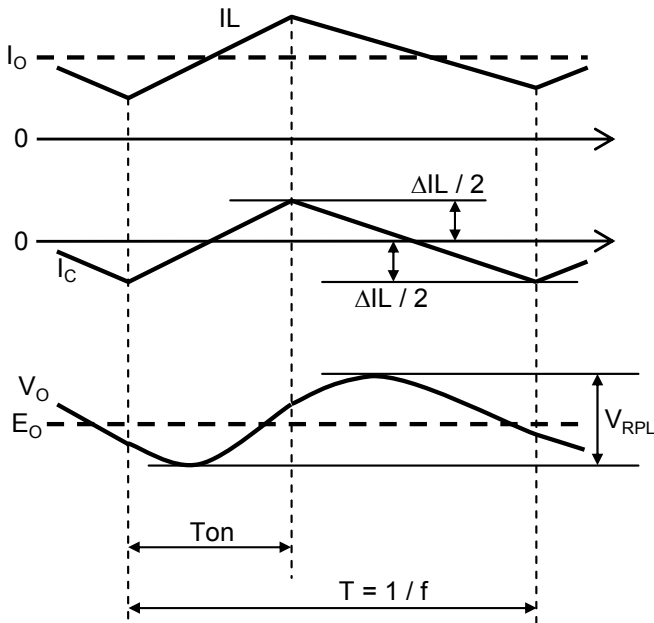

Figure : Power ON / OFF Sequence

**OPERATION (Continued)**

**7. Inductor and Output Capacitor Setting**



Given the desired input and output voltages, the inductor value and operating frequency determine the ripple current.

$$\Delta IL = \frac{E_o \cdot (E_i - E_o)}{E_i \cdot L_o \cdot f}$$

$$I_{ox} = \frac{\Delta IL}{2}$$

Highest efficiency operation is obtained at low frequency with small ripple current. However, achieving this requires a large inductor. There is a trade off among component size, efficiency and operating frequency. A reasonable starting point is to choose a ripple current that is about 40 % of  $I_o(\text{Max})$ . The largest ripple current occurs at the highest  $E_i$ . To guarantee that ripple current does not exceed a specified maximum, the inductance should be chosen according to:

$$L_o \geq \frac{E_o \cdot (E_i - E_o)}{2E_i \cdot I_{ox} \cdot f} \quad @ E_i = E_{i\_max}$$

And its maximum current rating is

$$I_{L\_max} = I_{o\_max} + \frac{\Delta IL}{2} \quad @ E_i = E_{i\_max}$$

The selection of  $C_o$  is primarily determined by the ESR ( $R_c$ ) required to minimize voltage ripple and load transients. The output ripple  $V_{RPL}$  is approximately bounded by:

$$\begin{aligned} V_{rpl} &= V_{op} - V_{ob} = E_i \cdot \frac{C_o \cdot R_c^2}{2L_o} + \frac{\Delta IL}{8C_o \cdot f} \\ &= E_i \cdot \frac{C_o \cdot R_c^2}{2L_o} + \frac{E_o \cdot (E_i - E_o)}{8E_i \cdot L_o \cdot C_o \cdot f^2} \end{aligned}$$

From the above equation, to achieve desired output ripple, low ESR ceramic capacitors are recommended, and its required RMS current rating is:

$$I_{c(rms)\_max} = \frac{\Delta IL}{2\sqrt{3}} \quad @ E_i = E_{i\_max}$$

## TYPICAL CHARACTERISTICS CURVES

### 1. Output Ripple Voltage

Condition :  $V_{IN} = 12\text{ V}$ ,  $V_{OUT}$  Setting = 1.05 V, Switching Frequency = 750 kHz, Skip Mode,  
 $L_O = 1\text{ }\mu\text{H}$ ,  $C_O = 44\text{ }\mu\text{F}$  (22  $\mu\text{F}$  x 2)

$I_{OUT} = 0\text{ A}$

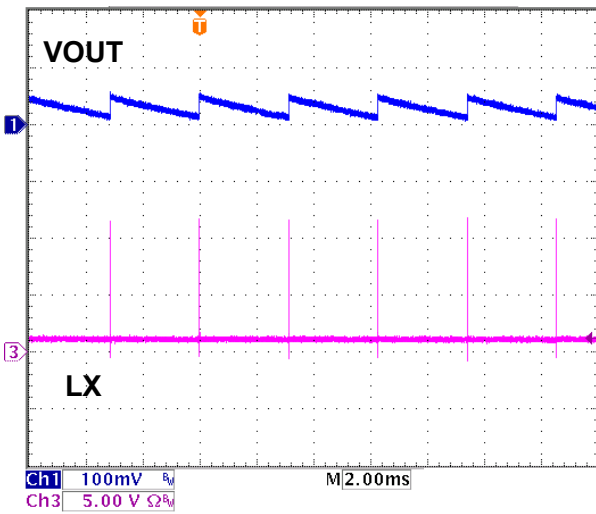

$I_{OUT} = 0.1\text{ A}$

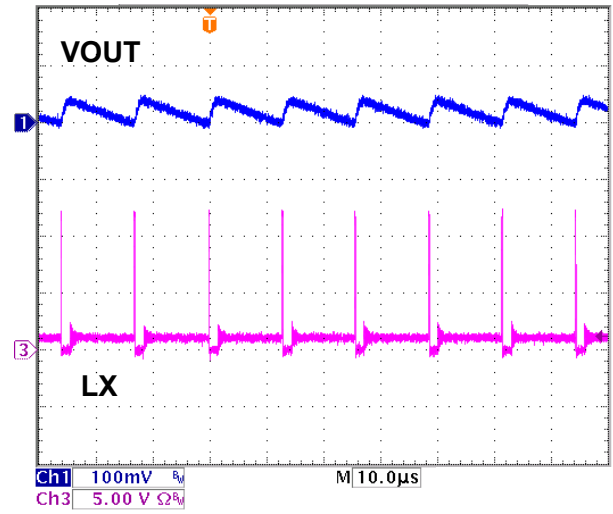

$I_{OUT} = 1\text{ A}$

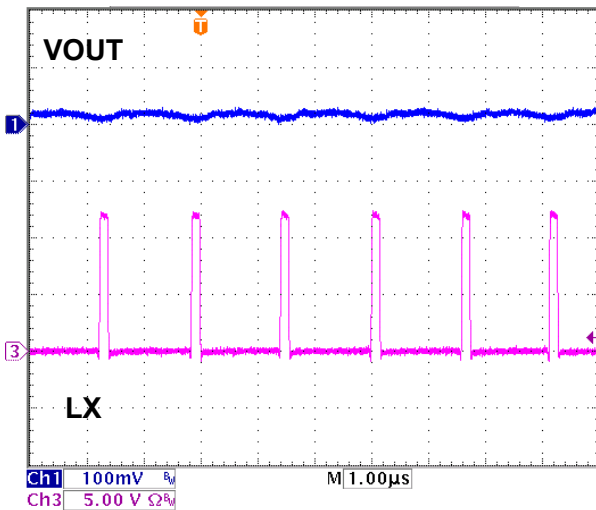

$I_{OUT} = 3\text{ A}$

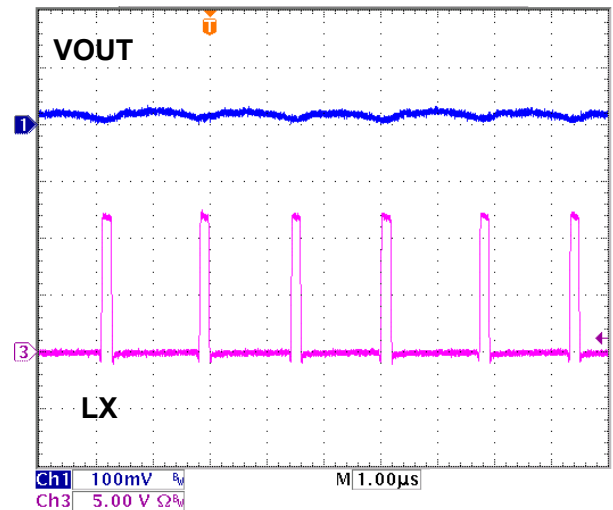



## TYPICAL CHARACTERISTICS CURVES (Continued)

### 1. Output Ripple Voltage (Continued)

Condition :  $V_{IN} = 12\text{ V}$ ,  $V_{OUT}$  Setting = 1.05 V, Switching Frequency = 750 kHz, FCCM,  
 $L_O = 1\ \mu\text{H}$ ,  $C_O = 44\ \mu\text{F}$  (22  $\mu\text{F}$  x 2)

$I_{OUT} = 0\text{ A}$

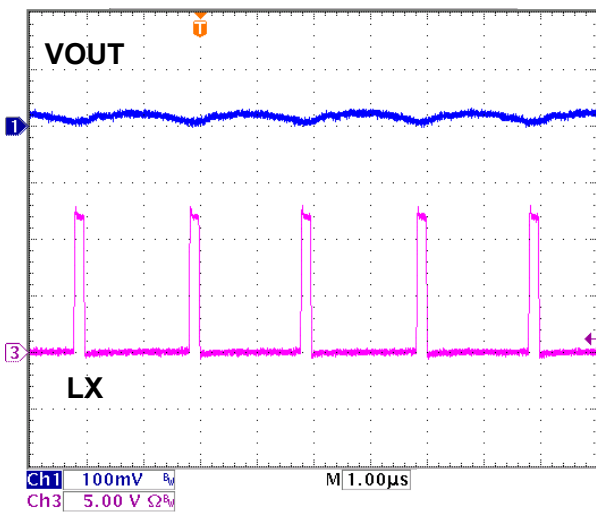

$I_{OUT} = 0.1\text{ A}$

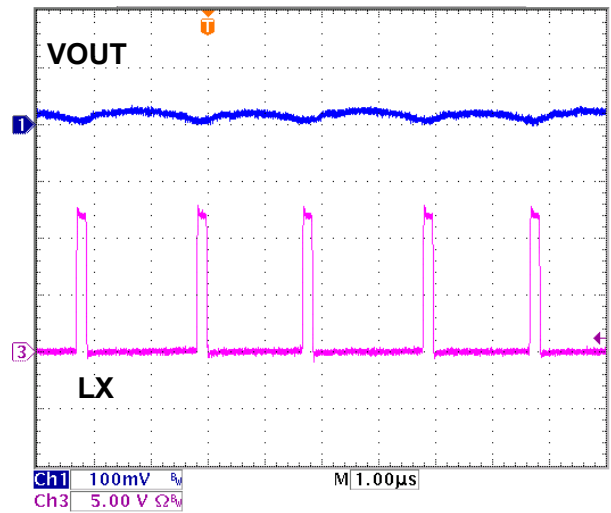

$I_{OUT} = 1\text{ A}$

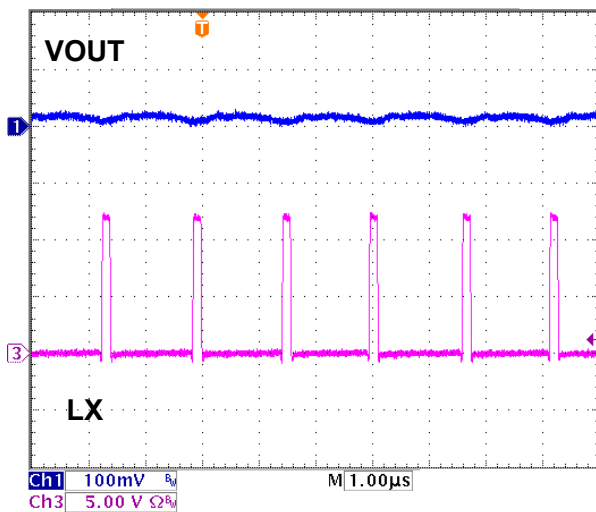

$I_{OUT} = 3\text{ A}$

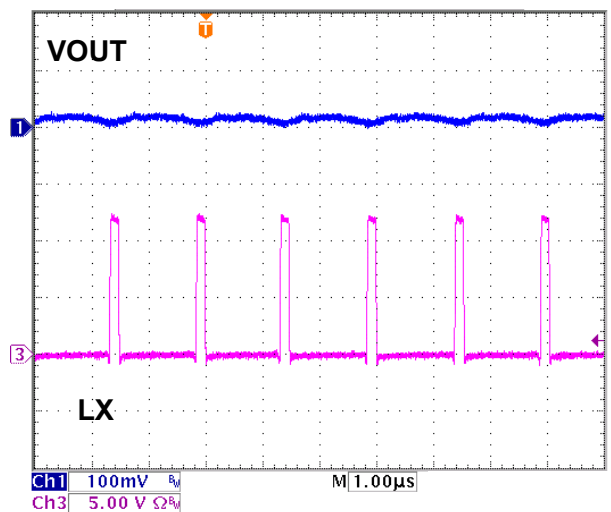

## TYPICAL CHARACTERISTICS CURVES (Continued)

### 2. Load transient response

Condition :  $V_{IN} = 12\text{ V}$ ,  $V_{OUT}$  Setting = 1.05 V, Switching Frequency = 750 kHz,  $I_{OUT} = 50\text{ mA}$  to 3 A (0.15 A /  $\mu\text{s}$ ),  
 $L_O = 1\ \mu\text{H}$ ,  $C_O = 44\ \mu\text{F}$  (22  $\mu\text{F} \times 2$ )

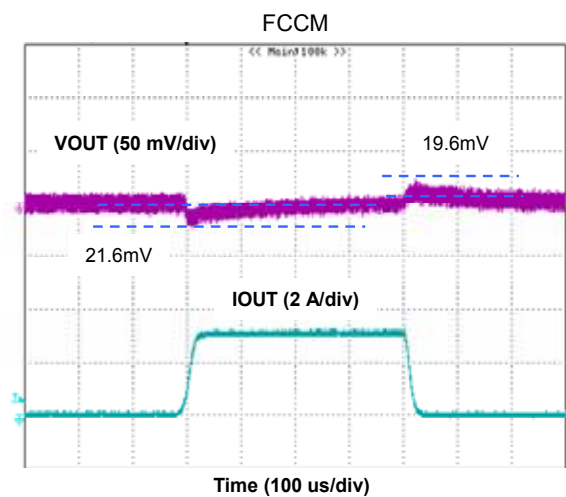
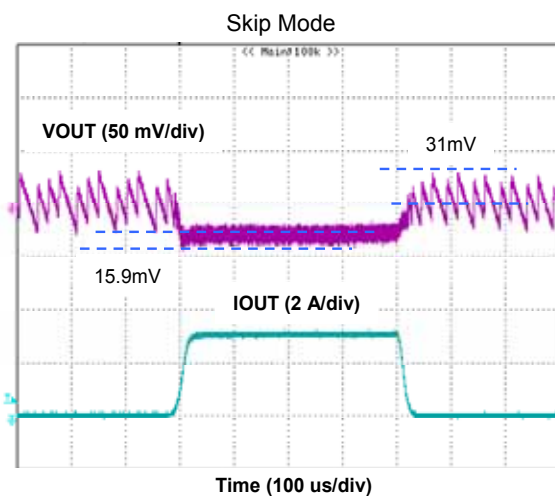

Condition :  $V_{IN} = 12\text{ V}$ ,  $V_{OUT} = 1.05\text{ V}$ , Switching Frequency = 750 kHz,  $I_{OUT} = 0.1\text{ A}$  to 3 A (0.15 A /  $\mu\text{s}$ ),  
 $L_O = 1\ \mu\text{H}$ ,  $C_O = 44\ \mu\text{F}$  (22  $\mu\text{F} \times 2$ )

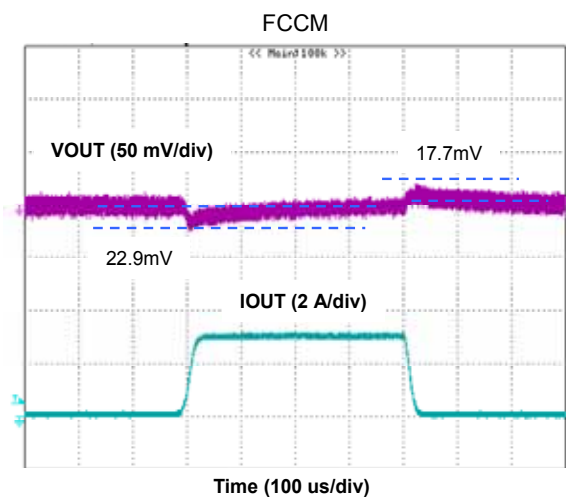
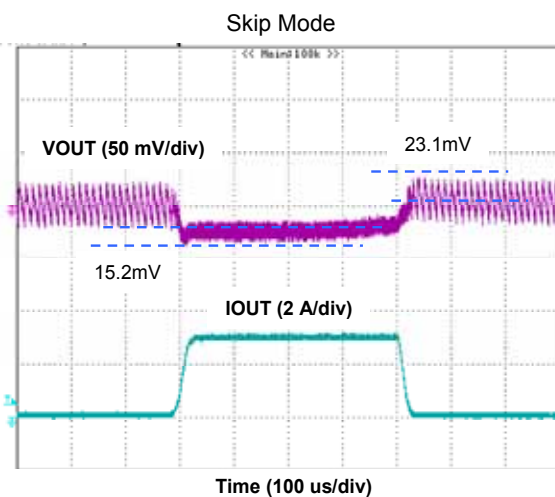

TYPICAL CHARACTERISTICS CURVES (Continued)

3. Efficiency

Condition :  $V_{IN} = 12\text{ V}$ ,  $V_{OUT}$  Setting = 1.05 V / 1.2 V / 1.8 V / 3.3 V / 5.0 V, Switching Frequency = 250 kHz,  
 $L_O = 4.7\ \mu\text{H}$ ,  $C_O = 44\ \mu\text{F}$  (22  $\mu\text{F}$  x 2)

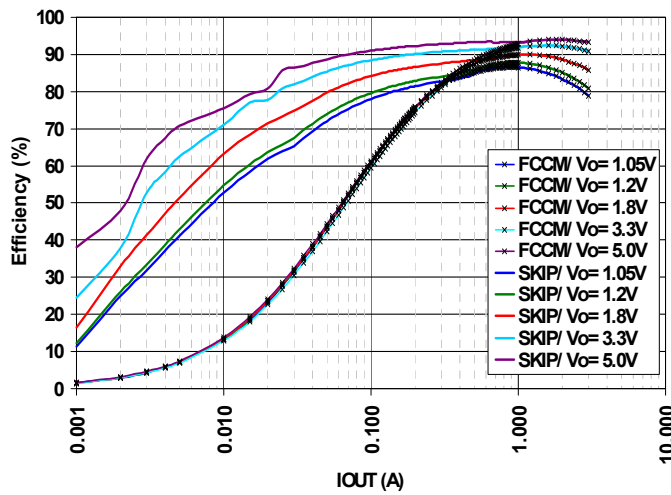

Condition :  $V_{IN} = 12\text{ V}$ ,  $V_{OUT}$  Setting = 1.05 V / 1.2 V / 1.8 V / 3.3 V / 5.0 V, Switching Frequency = 750 kHz,  
 $L_O = 1\ \mu\text{H}$ ,  $C_O = 44\ \mu\text{F}$  (22  $\mu\text{F}$  x 2)

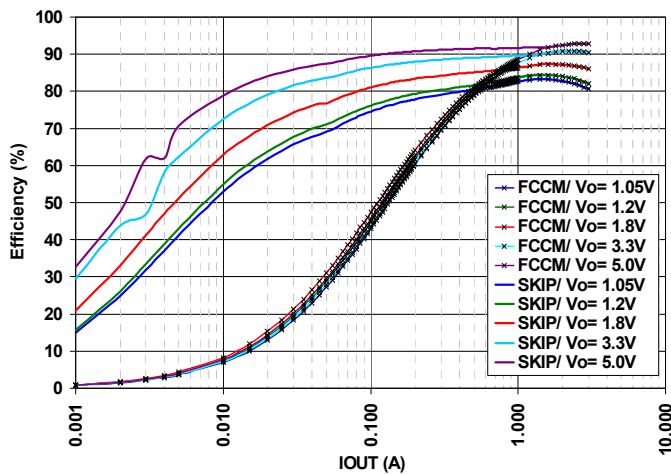

**TYPICAL CHARACTERISTICS CURVES (Continued)**

**4. Load Regulation**

Condition :  $V_{IN} = 12\text{ V}$ ,  $V_{OUT}$  Setting = 1.05 V, Switching Frequency = 250 kHz,  $L_O = 4.7\ \mu\text{H}$ ,  $C_O = 44\ \mu\text{F}$  (22  $\mu\text{F}$  x 2)

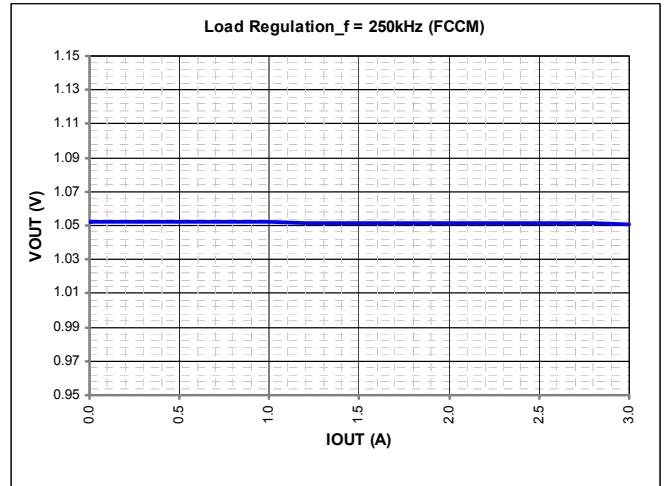
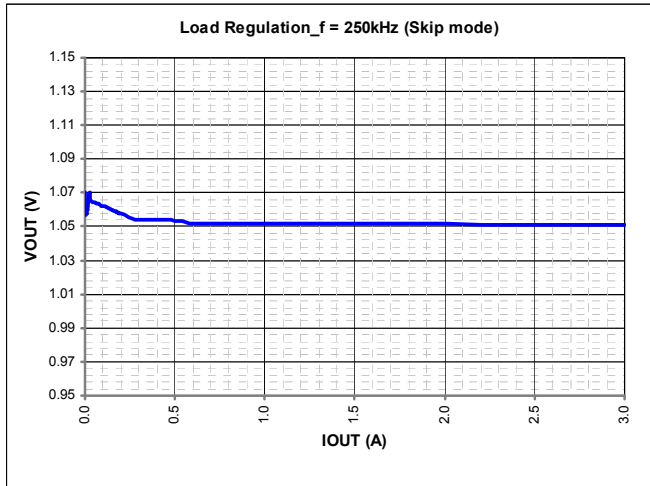

Condition :  $V_{IN} = 12\text{ V}$ ,  $V_{OUT}$  Setting = 1.05 V, Switching Frequency = 750 kHz,  $L_O = 1\ \mu\text{H}$ ,  $C_O = 44\ \mu\text{F}$  (22  $\mu\text{F}$  x 2)

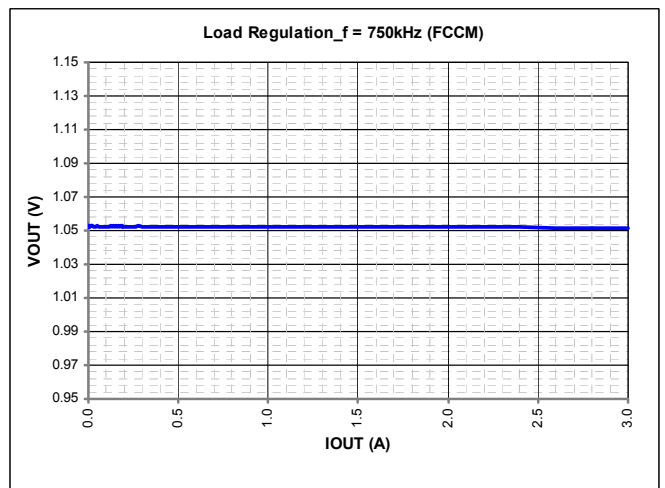
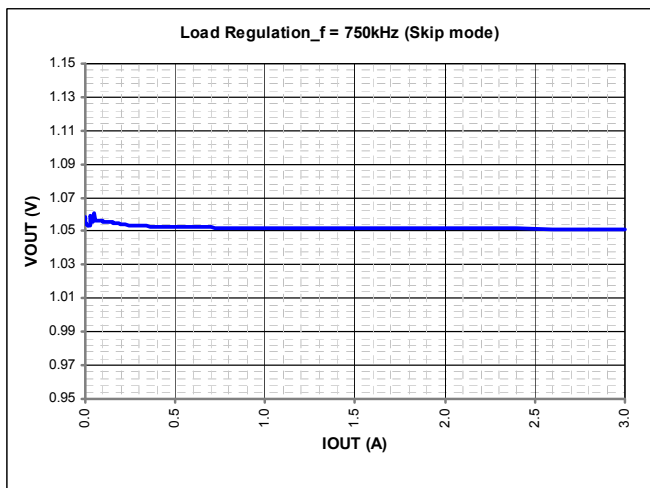

**TYPICAL CHARACTERISTICS CURVES (Continued)**

5. Line Regulation

Condition :  $V_{OUT}$  Setting = 1.05 V, Switching Frequency = 750 kHz, FCCM,  $I_{OUT}$  = 1.5 A,  
 $L_O$  = 1  $\mu$ H,  $C_O$  = 44  $\mu$ F (22  $\mu$ F x 2)

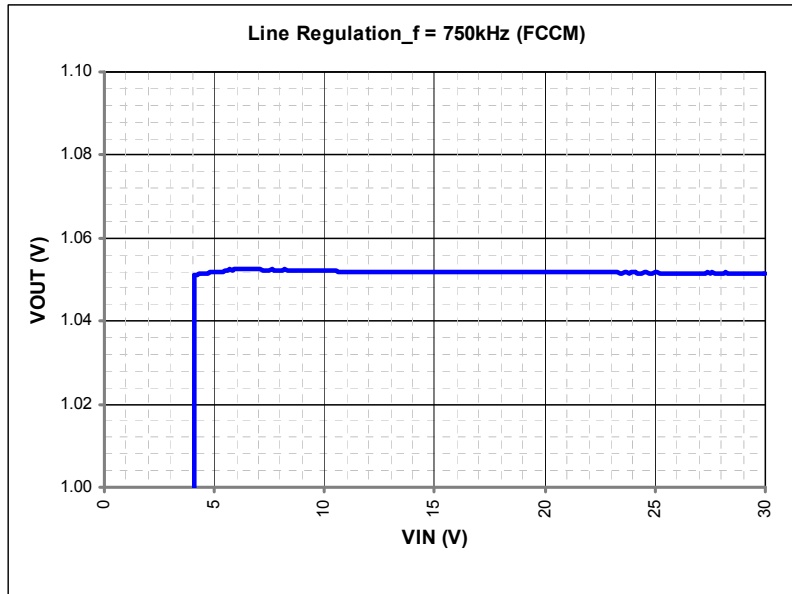

## TYPICAL CHARACTERISTICS CURVES (Continued)

### 6. Start / Shut Down

Condition :  $V_{IN} = 12\text{ V}$ ,  $V_{OUT}$  Setting = 1.05 V, Switching Frequency = 750 kHz, Skip Mode,  $I_{OUT} = 0\text{ A}$ ,  
 $L_O = 1\text{ }\mu\text{H}$ ,  $C_O = 44\text{ }\mu\text{F}$  (22  $\mu\text{F}$  x 2)

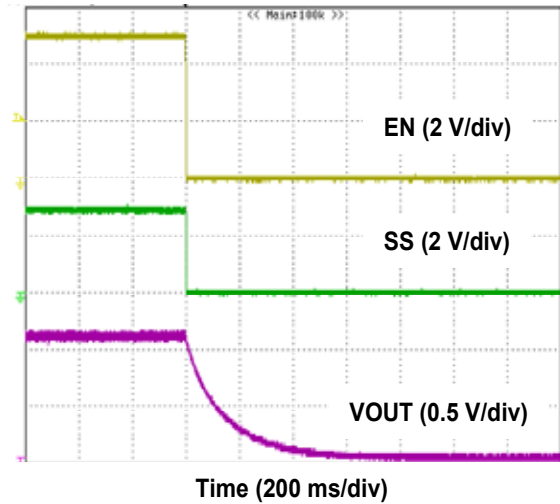
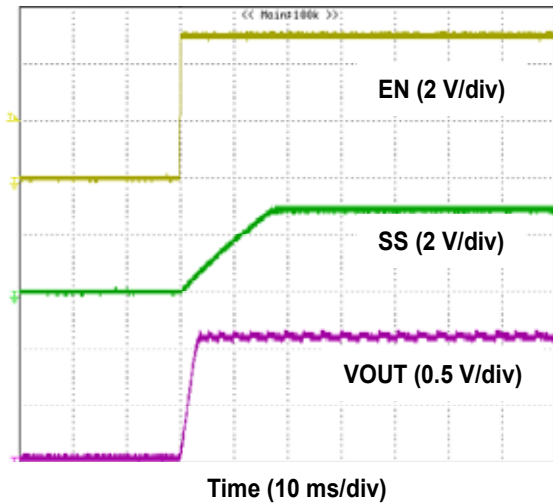

Condition :  $V_{IN} = 12\text{ V}$ ,  $V_{OUT}$  Setting = 1.05 V, Switching Frequency = 750 kHz, FCCM,  $I_{OUT} = 0\text{ A}$ ,  
 $L_O = 1\text{ }\mu\text{H}$ ,  $C_O = 44\text{ }\mu\text{F}$  (22  $\mu\text{F}$  x 2)

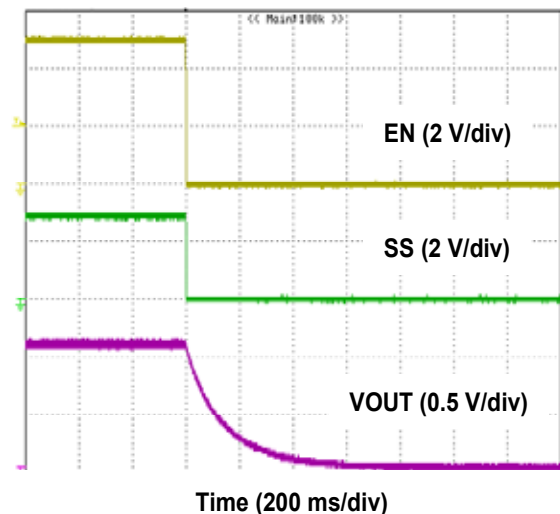
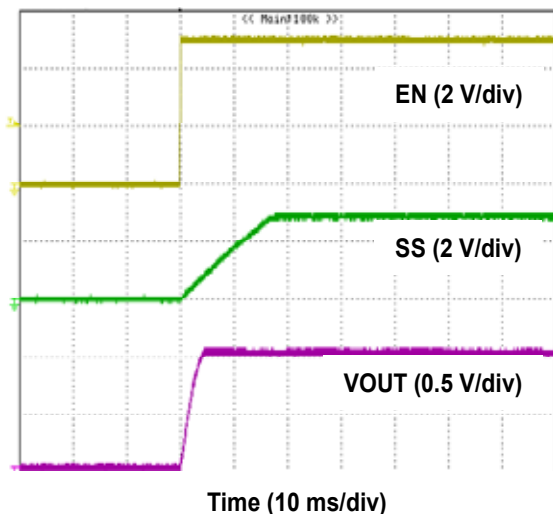

## TYPICAL CHARACTERISTICS CURVES (Continued)

### 6. Start / Shut Down (Continued)

Condition :  $V_{IN} = 12\text{ V}$ ,  $V_{OUT}$  Setting = 1.05 V, Switching Frequency = 750 kHz, Skip Mode,  $R_{LOAD} = 0.5\ \Omega$ ,  
 $L_O = 1\ \mu\text{H}$ ,  $C_O = 44\ \mu\text{F}$  (22  $\mu\text{F} \times 2$ )

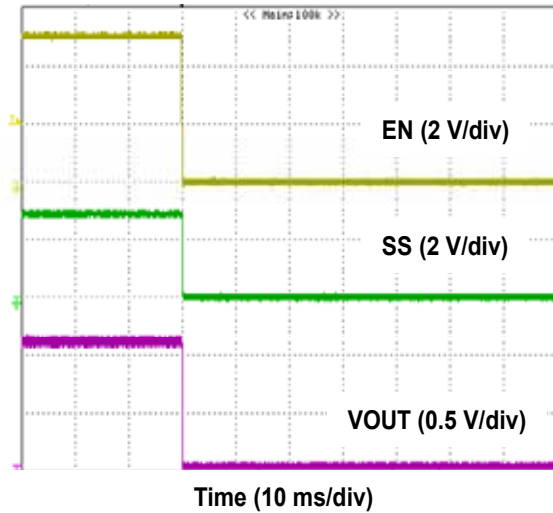
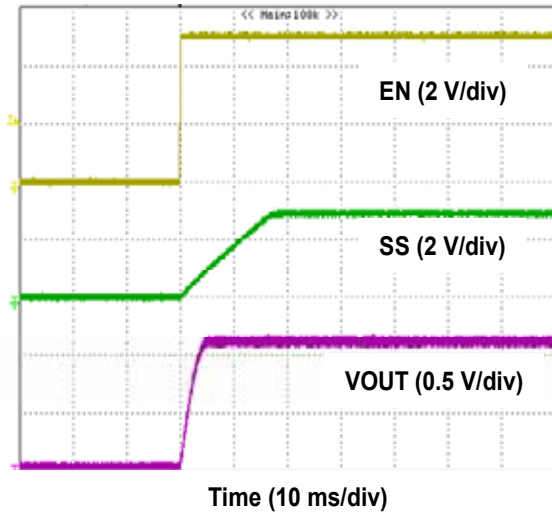

Condition :  $V_{IN} = 12\text{ V}$ ,  $V_{OUT}$  Setting = 1.05 V, Switching Frequency = 750 kHz, FCCM,  $R_{LOAD} = 0.5\ \Omega$ ,  
 $L_O = 1\ \mu\text{H}$ ,  $C_O = 44\ \mu\text{F}$  (22  $\mu\text{F} \times 2$ )

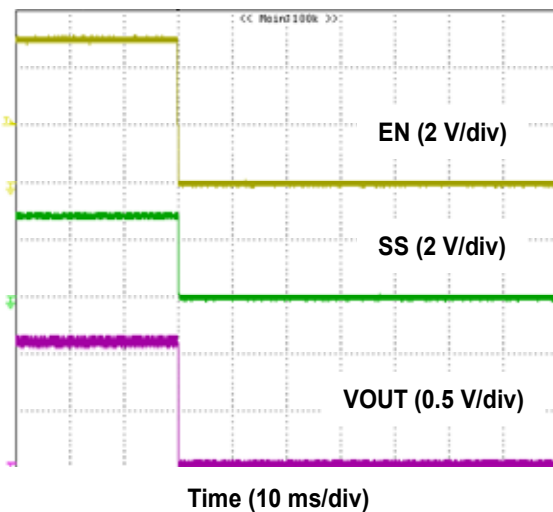
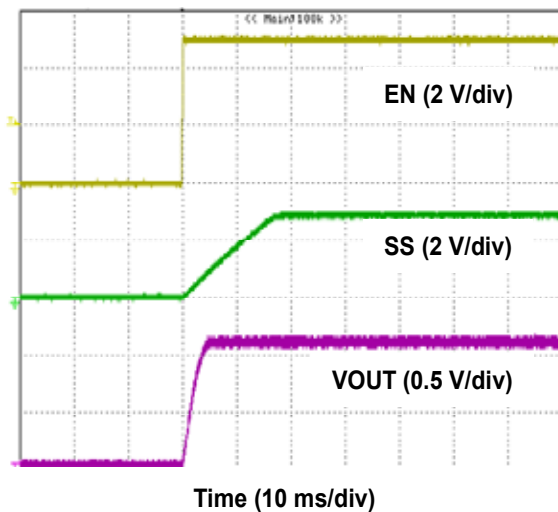

**TYPICAL CHARACTERISTICS CURVES (Continued)**

7. Short Circuit Protection

Condition :  $V_{IN} = 12\text{ V}$ ,  $V_{OUT}$  Setting = 1.05 V, Switching Frequency = 750 kHz,  $L_O = 1\ \mu\text{H}$ ,  $C_O = 44\ \mu\text{F}$  ( $22\ \mu\text{F} \times 2$ )

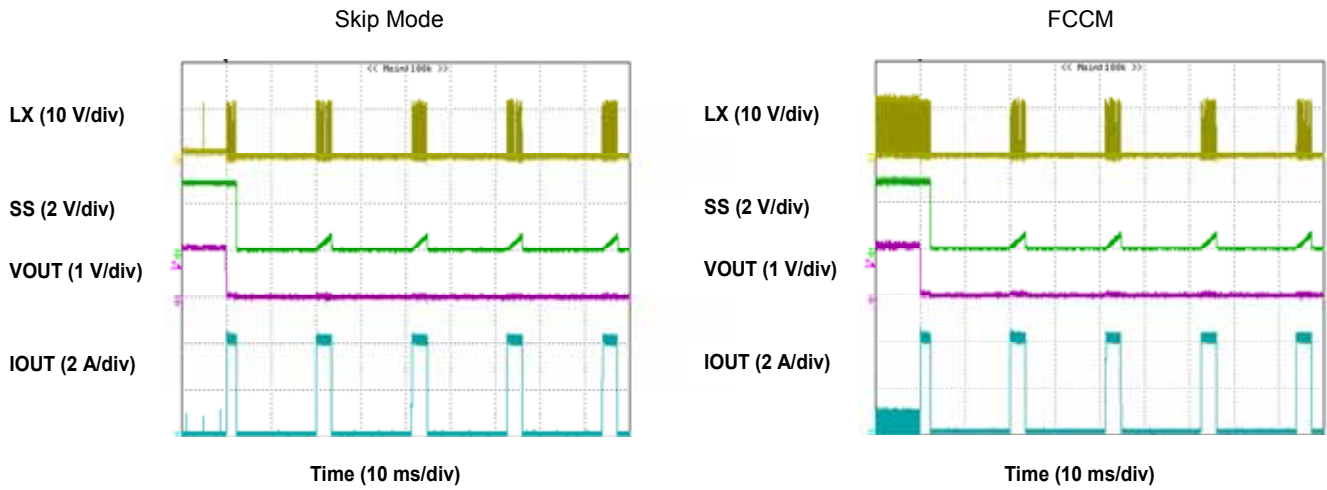



**TYPICAL CHARACTERISTICS CURVES (Continued)**

**8. Switching Frequency**

Condition :  $V_{IN} = 12\text{ V}$ ,  $V_{OUT}$  Setting = 1.05 V, Switching Frequency = 750 kHz,  $I_{OUT} = 10\text{ mA}$  to 3 A,  
 $L_O = 1\text{ }\mu\text{H}$ ,  $C_O = 44\text{ }\mu\text{F}$  (22  $\mu\text{F}$  x 2)

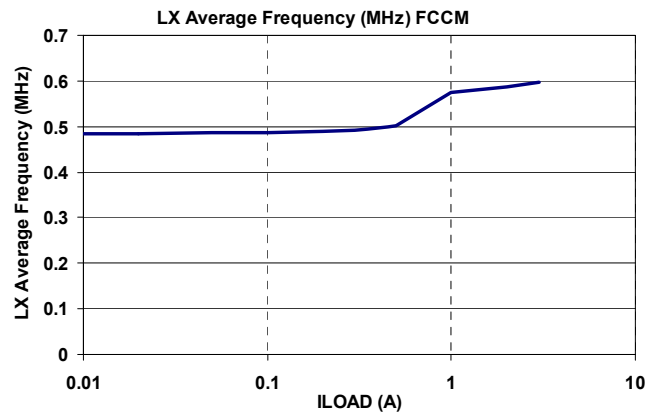
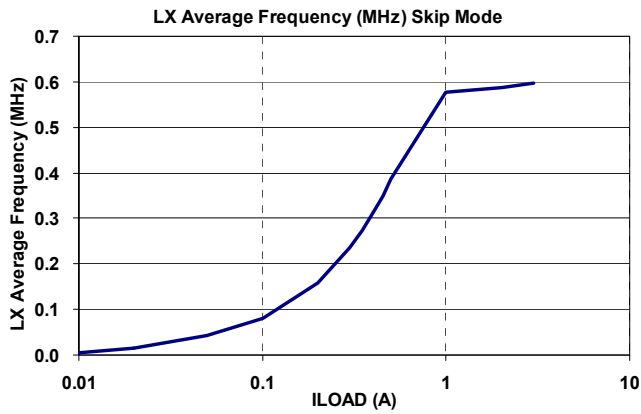

Condition :  $V_{OUT}$  Setting = 1.05 V, Switching Frequency = 750 kHz,  $I_{OUT} = 1.5\text{ A}$ ,  $L_O = 1\text{ }\mu\text{H}$ ,  $C_O = 44\text{ }\mu\text{F}$  (22  $\mu\text{F}$  x 2)

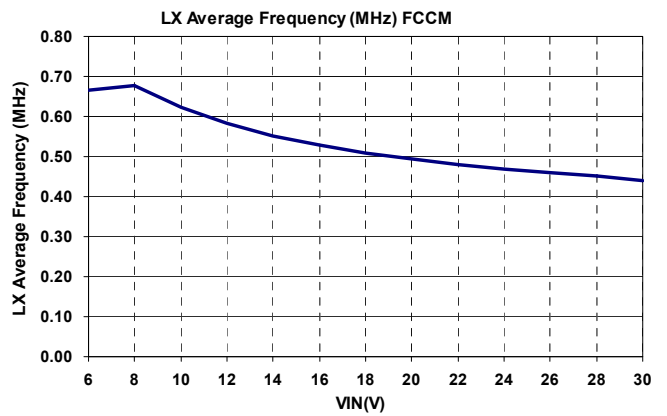
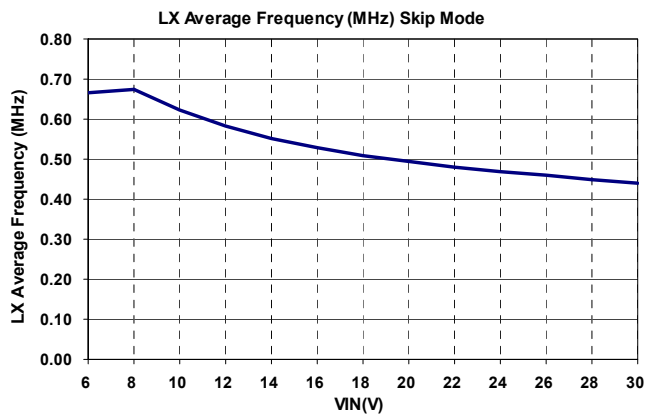

**TYPICAL CHARACTERISTICS CURVES (Continued)**

9. Thermal Performance

Condition :  $V_{IN} = 12\text{ V}$ ,  $V_{OUT}$  Setting = 1.05 V, Switching Frequency = 750 kHz, FCCM,  $I_{OUT} = 3\text{ A}$ ,  
 $L_O = 1\text{ }\mu\text{H}$ ,  $C_O = 44\text{ }\mu\text{F}$  (22  $\mu\text{F}$  x 2)

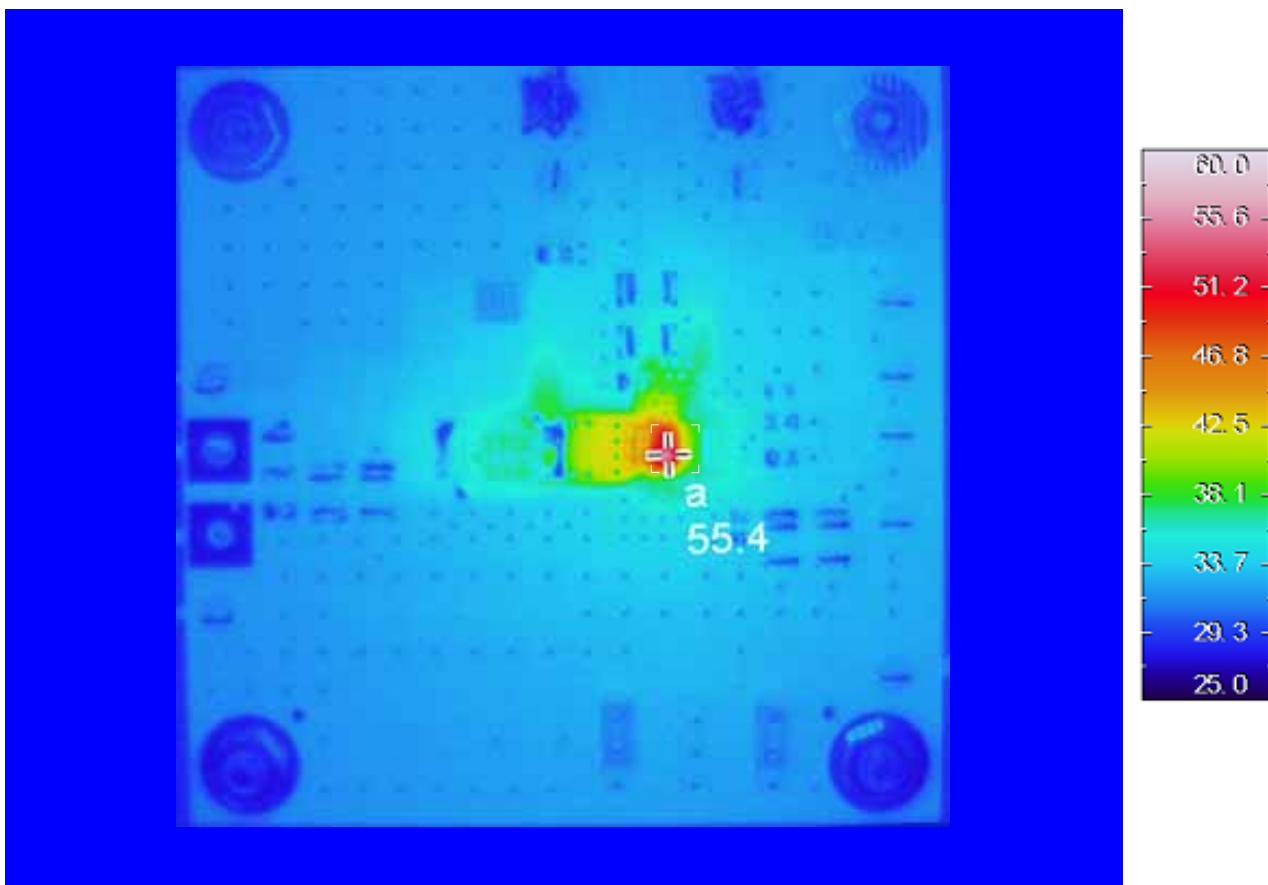



**APPLICATIONS INFORMATION (Continued)**

**2. Layout Recommendations**

Board layout considerations are necessary for stable operation of the DC-DC regulator. The following precautions must be used when designing the board layout.

- (a) The Input capacitor  $C_{IN}$  must be placed in such a way that the distance between PVIN and PGND is minimum, in order to suppress the switching noise. Stray inductance and impedance should be reduced as indicated by loop (1) in the figure below.
- (b) A single point ground connection (2) must be used to connect PGND and AGND to improve operation stability.
- (c) Output current line  $I_{OUT}$  and the output sense line VOUT must have small common impedance to reduce output load variations. Output sense line VOUT must be close to the output condenser  $C_O$  as indicated by (3) below.
- (d) Power Loss and output ripple voltage can be reduced by placing the inductor  $L_O$  and output capacitor  $C_O$  such that the stray inductance and the impedance of loop (4) is minimum. This is realized by :
  - i) Minimizing distance between inductor  $L_O$  and LX pin.
  - ii) Reducing distance between output capacitor  $C_O$  and (2) / (3)
- (e) Thick lines in the application circuit example represent lines with large current flow. These lines should be designed as thick as possible.
- (f) VFB / SS / VREG lines should be placed far away from LX line, BST line and inductor  $L_O$  to reduce the effects of switching noise. These lines should be designed as short as possible. This is especially true for the VFB line, which is a high impedance line.
- (g)  $R_{FB1}$  /  $R_{FB2}$  should also be placed as far away as possible from LX line, BST line and inductor  $L_O$  to minimize the effects of switching noise.  $R_{FB1}$  /  $R_{FB2}$  should be placed close to the VFB pin.
- (h) LX / BST lines are noisy lines. They should be designed as short as possible.

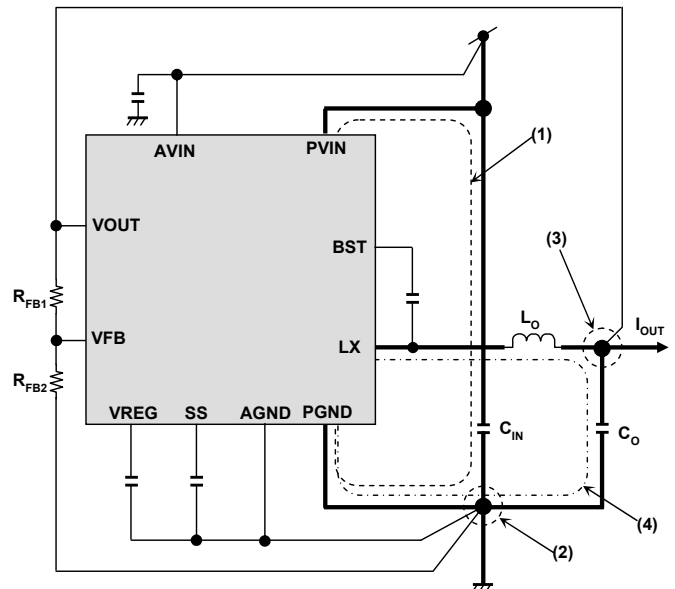

Figure : Application circuit diagram

Note : The application circuit diagram and layout diagram explained in this section, should be used as reference examples. The operation of the mass production set is not guaranteed. Sufficient evaluation and verification is required in the design of the mass production set. The Customer is fully responsible for the incorporation of the above illustrated application circuit and the information attached with it, in the design of the equipment.

**APPLICATIONS INFORMATION (Continued)**

3. Recommended component

Reference Designator	QTY	Value	Manufacturer	Part Number	Note
C-AVIN1	2	10 $\mu$ F	TAIYO YUDEN	UMK325AB7106MM-T	—
C-AVIN2	1	0.1 $\mu$ F	Murata	GRM188R72A104KA35L	—
C-BST	1	0.1 $\mu$ F	Murata	GRM188R72A104KA35L	—
C-DCDCOUT	2	22 $\mu$ F	Murata	GRM32ER71E226KE15L	—
C-PVIN5	2	10 $\mu$ F	TAIYO YUDEN	UMK325AB7106MM-T	—
C-PVIN6	1	0.1 $\mu$ F	Murata	GRM188R72A104KA35L	—
C-SS	1	10 nF	Murata	GRM188R72A103KA01L	—
C-VREG	1	1.0 $\mu$ F	Murata	GRM188R71E105KA12L	—
L-LX	1	1.0 $\mu$ H	Panasonic	ETQP3W1R0WFN	FSEL : GND (1250 kHz) OPEN (750 kHz)
		4.7 $\mu$ H	Panasonic	ETQ3W4R7WFN	FSEL : VREG (250 kHz)
R-FB1	1	3.3 k $\Omega$	Panasonic	ERJ3EKF3301V	—
R-FB2	1	1.2 k $\Omega$	Panasonic	ERJ3EKF1201V	—
R-FB3	1	1.0 k $\Omega$	Panasonic	ERJ3EKF1001V	—
R-FB4	1	0 k $\Omega$	Panasonic	ERJ3GEY0R00V	—
R-PG	1	100k $\Omega$	Panasonic	ERJ3EKF1003V	—

**PACKAGE INFORMATION**

Outline Drawing

Package Code : HQFN024-A3-0404

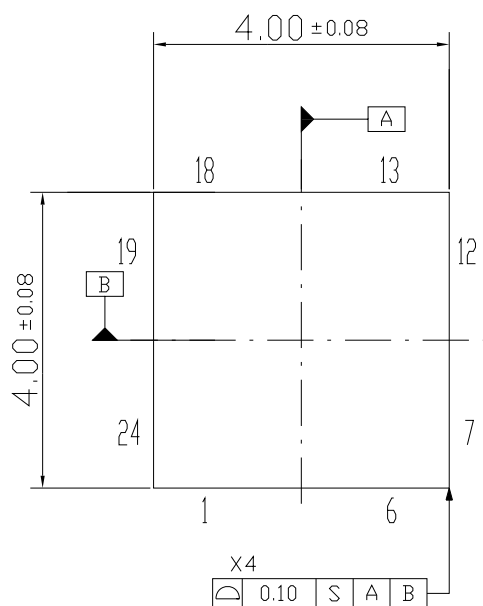

Unit : mm

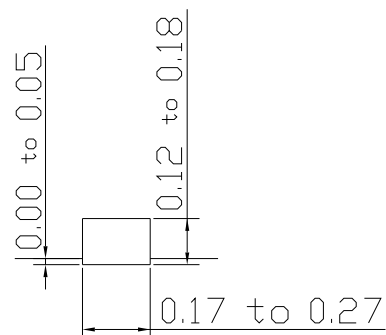
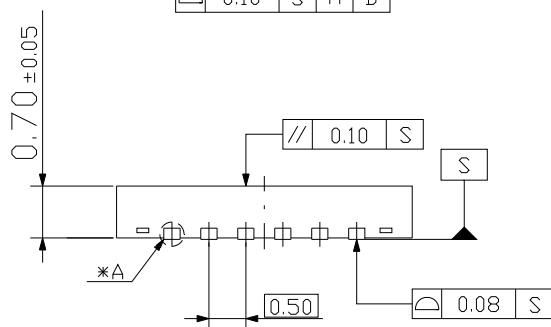

Detail \*A (Reference)

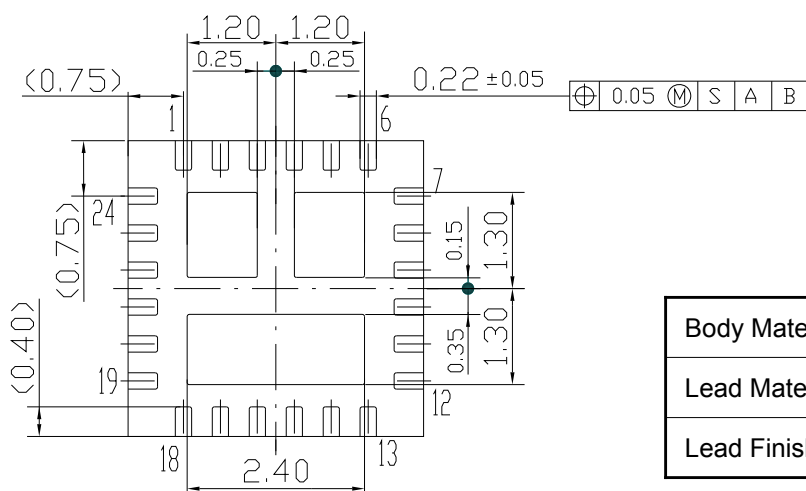

Body Material	: Br / Sb Free Epoxy Resin
Lead Material	: Cu Alloy
Lead Finish Method	: Pd Plating

## IMPORTANT NOTICE

1. When using the IC for new models, verify the safety including the long-term reliability for each product.
2. When the application system is designed by using this IC, please confirm the notes in this book.  
Please read the notes to descriptions and the usage notes in the book.
3. This IC is intended to be used for general electronic equipment.  
Consult our sales staff in advance for information on the following applications: Special applications in which exceptional quality and reliability are required, or if the failure or malfunction of this IC may directly jeopardize life or harm the human body.  
Any applications other than the standard applications intended.
  - (1) Space appliance (such as artificial satellite, and rocket)
  - (2) Traffic control equipment (such as for automotive, airplane, train, and ship)
  - (3) Medical equipment for life support
  - (4) Submarine transponder
  - (5) Control equipment for power plant
  - (6) Disaster prevention and security device
  - (7) Weapon
  - (8) Others : Applications of which reliability equivalent to (1) to (7) is requiredOur company shall not be held responsible for any damage incurred as a result of or in connection with the IC being used for any special application, unless our company agrees to the use of such special application.  
However, for the IC which we designate as products for automotive use, it is possible to be used for automotive.
4. This IC is neither designed nor intended for use in automotive applications or environments unless the IC is designated by our company to be used in automotive applications.  
Our company shall not be held responsible for any damage incurred by customers or any third party as a result of or in connection with the IC being used in automotive application, unless our company agrees to such application in this book.
5. Please use this IC in compliance with all applicable laws and regulations that regulate the inclusion or use of controlled substances, including without limitation, the EU RoHS Directive. Our company shall not be held responsible for any damage incurred as a result of our IC being used by our customers, not complying with the applicable laws and regulations.
6. Pay attention to the direction of the IC. When mounting it in the wrong direction onto the PCB (printed-circuit-board), it might be damaged.
7. Pay attention in the PCB (printed-circuit-board) pattern layout in order to prevent damage due to short circuit between pins. In addition, refer to the Pin Description for the pin configuration.
8. Perform visual inspection on the PCB before applying power, otherwise damage might happen due to problems such as solder-bridge between the pins of the IC. Also, perform full technical verification on the assembly quality, because the same damage possibly can happen due to conductive substances, such as solder ball, that adhere to the IC during transportation.
9. Take notice in the use of this IC that it might be damaged when an abnormal state occurs such as output pin-VCC short (Power supply fault), output pin-GND short (Ground fault), or output-to-output-pin short (load short). Safety measures such as installation of fuses are recommended because the extent of the above-mentioned damage will depend on the current capability of the power supply.
10. The protection circuit is for maintaining safety against abnormal operation. Therefore, the protection circuit should not work during normal operation.  
Especially for the thermal protection circuit, if the area of safe operation or the absolute maximum rating is momentarily exceeded due to output pin to VCC short (Power supply fault), or output pin to GND short (Ground fault), the IC might be damaged before the thermal protection circuit could operate.
11. Unless specified in the product specifications, make sure that negative voltage or excessive voltage are not applied to the pins because the IC might be damaged, which could happen due to negative voltage or excessive voltage generated during the ON and OFF timing when the inductive load of a motor coil or actuator coils of optical pick-up is being driven.
12. Product which has specified ASO (Area of Safe Operation) should be operated in ASO
13. Verify the risks which might be caused by the malfunctions of external components.
14. Connect the metallic plates (fins) on the back side of the IC with their respective potentials (AGND, PVIN, LX). The thermal resistance and the electrical characteristics are guaranteed only when the metallic plates (fins) are connected with their respective potentials.

## Request for your special attention and precautions in using the technical information and semiconductors described in this book

- (1) If any of the products or technical information described in this book is to be exported or provided to non-residents, the laws and regulations of the exporting country, especially, those with regard to security export control, must be observed.
- (2) The technical information described in this book is intended only to show the main characteristics and application circuit examples of the products. No license is granted in and to any intellectual property right or other right owned by Panasonic Corporation or any other company. Therefore, no responsibility is assumed by our company as to the infringement upon any such right owned by any other company which may arise as a result of the use of technical information described in this book.
- (3) The products described in this book are intended to be used for general applications (such as office equipment, communications equipment, measuring instruments and household appliances), or for specific applications as expressly stated in this book.  
Consult our sales staff in advance for information on the following applications:
  - Special applications (such as for airplanes, aerospace, automotive equipment, traffic signaling equipment, combustion equipment, life support systems and safety devices) in which exceptional quality and reliability are required, or if the failure or malfunction of the products may directly jeopardize life or harm the human body.It is to be understood that our company shall not be held responsible for any damage incurred as a result of or in connection with your using the products described in this book for any special application, unless our company agrees to your using the products in this book for any special application.
- (4) The products and product specifications described in this book are subject to change without notice for modification and/or improvement. At the final stage of your design, purchasing, or use of the products, therefore, ask for the most up-to-date Product Standards in advance to make sure that the latest specifications satisfy your requirements.
- (5) When designing your equipment, comply with the range of absolute maximum rating and the guaranteed operating conditions (operating power supply voltage and operating environment etc.). Especially, please be careful not to exceed the range of absolute maximum rating on the transient state, such as power-on, power-off and mode-switching. Otherwise, we will not be liable for any defect which may arise later in your equipment.  
Even when the products are used within the guaranteed values, take into the consideration of incidence of break down and failure mode, possible to occur to semiconductor products. Measures on the systems such as redundant design, arresting the spread of fire or preventing glitch are recommended in order to prevent physical injury, fire, social damages, for example, by using the products.
- (6) Comply with the instructions for use in order to prevent breakdown and characteristics change due to external factors (ESD, EOS, thermal stress and mechanical stress) at the time of handling, mounting or at customer's process. When using products for which damp-proof packing is required, satisfy the conditions, such as shelf life and the elapsed time since first opening the packages.
- (7) This book may be not reprinted or reproduced whether wholly or partially, without the prior written permission of our company.



# Mouser Electronics

Authorized Distributor

Click to View Pricing, Inventory, Delivery & Lifecycle Information:

[Panasonic:](#)

[NN30310AAVB](#)