



# STB30NF20L

## N-channel 200 V, 0.065 $\Omega$ , 30 A STripFET™ Power MOSFET in D<sup>2</sup>PAK package

Datasheet — production data

### Features

Order code	V <sub>DSS</sub>	R <sub>DS(on)</sub>	I <sub>D</sub>	P <sub>TOT</sub>
STB30NF20L	200 V	0.075 $\Omega$	30 A	150 W

- Gate charge minimized
- 100% avalanche tested
- Excellent figure of merit (R<sub>DS\*</sub> Q<sub>g</sub>)
- Very good manufacturing repeatability
- Very low intrinsic capacitance

### Applications

- Automotive

### Description

This N-channel enhancement mode Power MOSFET benefits from the latest refinement of STMicroelectronics' unique "single feature size" strip-based process, which decreases the critical alignment steps to offer exceptional manufacturing reproducibility. The result is a transistor with extremely high packing density for low on-resistance, rugged avalanche characteristics and low gate charge.

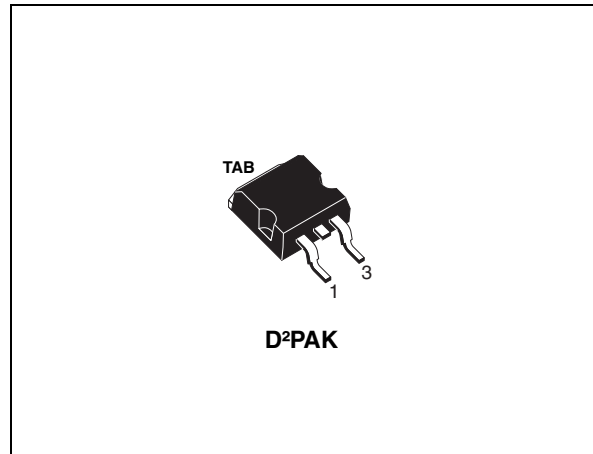

Figure 1. Internal schematic diagram

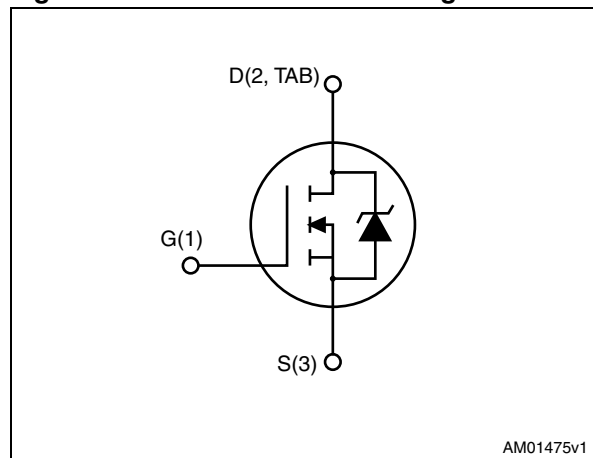

Table 1. Device summary

Order code	Marking	Package	Packaging
STB30NF20L	30NF20L	D <sup>2</sup> PAK	Tape and reel

---

## Contents

<b>1</b>	<b>Electrical ratings</b> .....	<b>3</b>
<b>2</b>	<b>Electrical characteristics</b> .....	<b>4</b>
	2.1 Electrical characteristics (curves) .....	6
<b>3</b>	<b>Test circuit</b> .....	<b>8</b>
<b>4</b>	<b>Package mechanical data</b> .....	<b>9</b>
<b>5</b>	<b>Packaging mechanical data</b> .....	<b>12</b>
<b>6</b>	<b>Revision history</b> .....	<b>14</b>

# 1 Electrical ratings

**Table 2. Absolute maximum ratings**

Symbol	Parameter	Value	Unit
$V_{DS}$	Drain-source voltage	200	V
$V_{GS}$	Gate-source voltage	$\pm 20$	V
$I_D$	Drain current (continuous) at $T_C = 25\text{ }^\circ\text{C}$	30	A
$I_D$	Drain current (continuous) at $T_C = 100\text{ }^\circ\text{C}$	19	A
$I_{DM}^{(1)}$	Drain current (pulsed)	120	A
$P_{TOT}$	Total dissipation at $T_C = 25\text{ }^\circ\text{C}$	150	W
	Derating factor	1	W/ $^\circ\text{C}$
$dv/dt^{(2)}$	Peak diode recovery voltage slope	10	V/ns
$T_J$ $T_{stg}$	Operating junction temperature Storage temperature	-55 to 175	$^\circ\text{C}$
$T_l$	Maximum lead temperature for soldering purpose	300	$^\circ\text{C}$

1. Pulse width limited by safe operating area.
2.  $I_{SD} \leq 30\text{A}$ ,  $di/dt \leq 200\text{A}/\mu\text{s}$ ,  $V_{DD} = 80\%V_{(BR)DSS}$ .

**Table 3. Thermal data**

Symbol	Parameter	Value	Unit
$R_{thJC}$	Thermal resistance junction-case max.	1	$^\circ\text{C}/\text{W}$
$R_{thJA}$	Thermal resistance junction-ambient max.	62.5	$^\circ\text{C}/\text{W}$

**Table 4. Avalanche data**

Symbol	Parameter	Value	Unit
$I_{AR}$	Avalanche current, repetitive or not repetitive (pulse width limited by $T_{jmax}$ )	30	A
$E_{AS}$	Single pulse avalanche energy (starting $T_j = 25\text{ }^\circ\text{C}$ , $I_D = I_{AR}$ , $V_{DD} = 50\text{ V}$ )	140	mJ

## 2 Electrical characteristics

( $T_{CASE}=25^{\circ}C$  unless otherwise specified).

**Table 5. On/off states**

Symbol	Parameter	Test conditions	Min.	Typ.	Max.	Unit
$V_{(BR)DSS}$	Drain-source breakdown voltage	$I_D = 1 \text{ mA}, V_{GS} = 0$	200			V
$I_{DSS}$	Zero gate voltage drain current ( $V_{GS} = 0$ )	$V_{DS} = 200 \text{ V},$ $V_{DS} = 200 \text{ V}, T_c = 125^{\circ}C$			1 10	$\mu\text{A}$ $\mu\text{A}$
$I_{GSS}$	Gate body leakage current ( $V_{DS} = 0$ )	$V_{GS} = \pm 20 \text{ V}$			$\pm 100$	nA
$V_{GS(th)}$	Gate threshold voltage	$V_{DS} = V_{GS}, I_D = 250 \mu\text{A}$	1	2	3	V
$R_{DS(on)}$	Static drain-source on resistance	$V_{GS} = 5 \text{ V}, I_D = 15 \text{ A}$		0.065	0.075	$\Omega$

**Table 6. Dynamic**

Symbol	Parameter	Test conditions	Min.	Typ.	Max.	Unit
$C_{iss}$	Input capacitance	$V_{DS} = 25 \text{ V}, f = 1 \text{ MHz}, V_{GS} = 0$	-	1990	-	pF
$C_{oss}$	Output capacitance			297		pF
$C_{rss}$	Reverse transfer capacitance			42		pF
$Q_g$	Total gate charge	$V_{DD} = 160 \text{ V}, I_D = 30 \text{ A}$	-	65	-	nC
$Q_{gs}$	Gate-source charge	$V_{GS} = 10 \text{ V}$		7		nC
$Q_{gd}$	Gate-drain charge	(see Figure 14)		21		nC

**Table 7. Switching times**

Symbol	Parameter	Test conditions	Min.	Typ.	Max.	Unit
$t_{d(on)}$	Turn-on delay time	$V_{DD} = 100 \text{ V}, I_D = 15 \text{ A},$ $R_G = 4.7 \Omega, V_{GS} = 10 \text{ V}$ (see Figure 13)	-	14	-	ns
$t_r$	Rise time			12		ns
$t_{d(off)}$	Turn-off delay time	$V_{DD} = 100 \text{ V}, I_D = 15 \text{ A},$ $R_G = 4.7 \Omega, V_{GS} = 10 \text{ V}$ (see Figure 13)	-	68	-	ns
$t_f$	Fall time			14		ns

**Table 8. Source drain diode**

Symbol	Parameter	Test conditions	Min.	Typ.	Max.	Unit
$I_{SD}$ $I_{SDM}^{(1)}$	Source-drain current Source-drain current (pulsed)	$V_{SD}=1.5\text{ V}$	-		30 120	A A
$V_{SD}^{(2)}$	Forward on voltage	$I_{SD}=30\text{ A}$ , $V_{GS}=0$	-		1.5	V
$t_{rr}$ $Q_{rr}$ $I_{RRM}$	Reverse recovery time Reverse recovery charge Reverse recovery current	$I_{SD}=30\text{ A}$ , $di/dt = 100\text{ A}/\mu\text{s}$ , $V_{DD}=100\text{ V}$	-	140 750 13		ns nC A
$t_{rr}$ $Q_{rr}$ $I_{RRM}$	Reverse recovery time Reverse recovery charge Reverse recovery current	$I_{SD}=30\text{ A}$ , $di/dt = 100\text{ A}/\mu\text{s}$ , $V_{DD}=100\text{ V}$ , $T_j=150\text{ }^\circ\text{C}$	-	170 1.1 14		ns $\mu\text{C}$ A

1. Pulse width limited by safe operating area.
2. Pulsed: pulse duration=300 $\mu\text{s}$ , duty cycle 1.5%

## 2.1 Electrical characteristics (curves)

Figure 2. Safe operating area

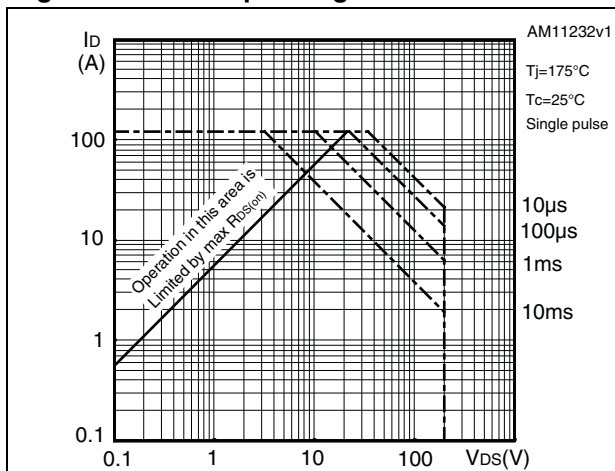

Figure 3. Thermal impedance

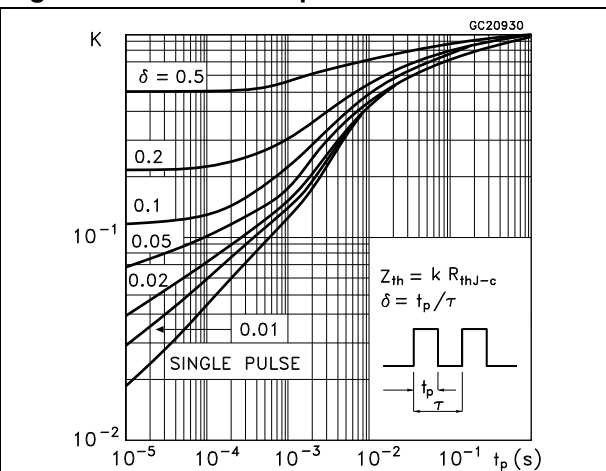

Figure 4. Output characteristics

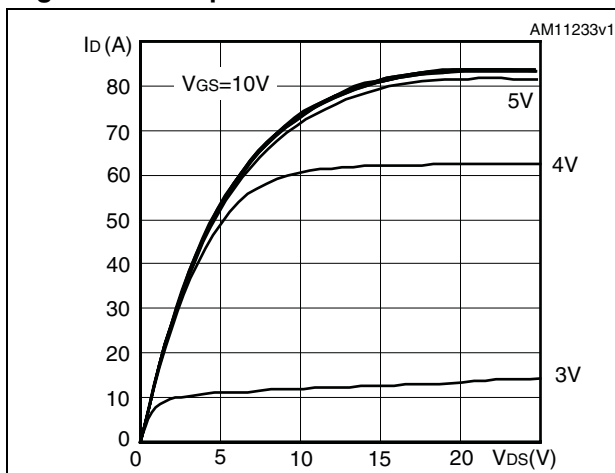

Figure 5. Transfer characteristics

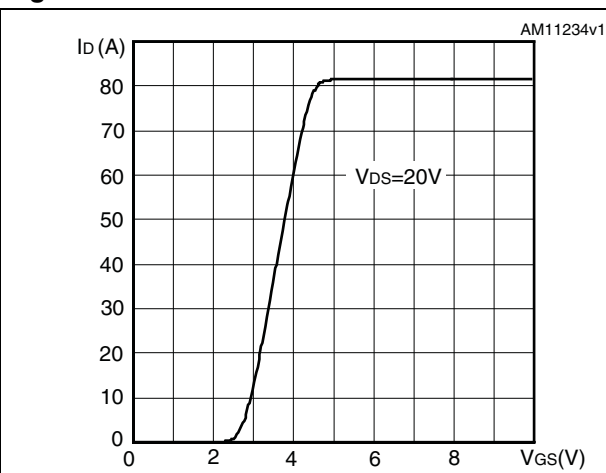

Figure 6. Normalized  $B_{V_{DS}}$  vs temperature

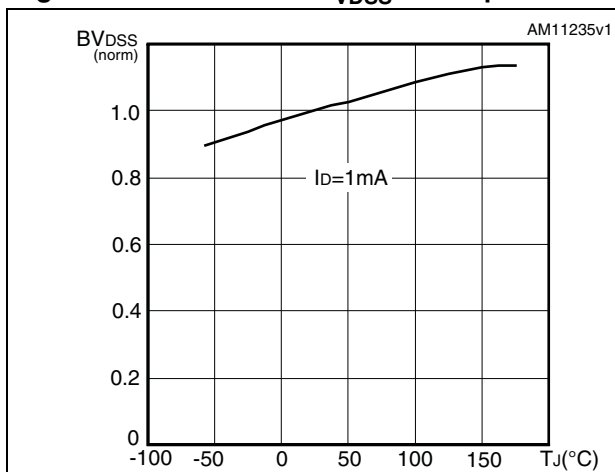

Figure 7. Static drain-source on-resistance

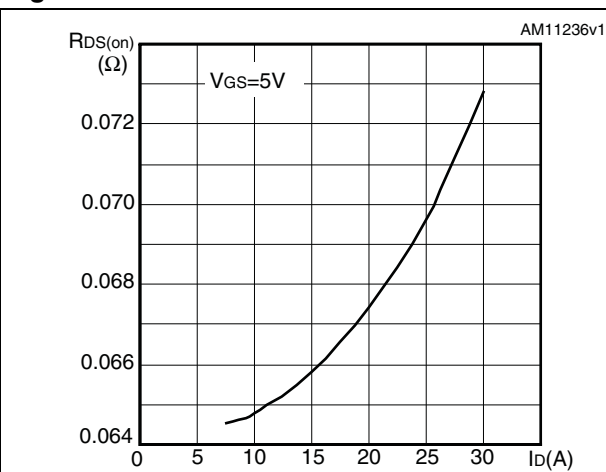

Figure 8. Gate charge vs gate-source voltage Figure 9. Capacitance variations

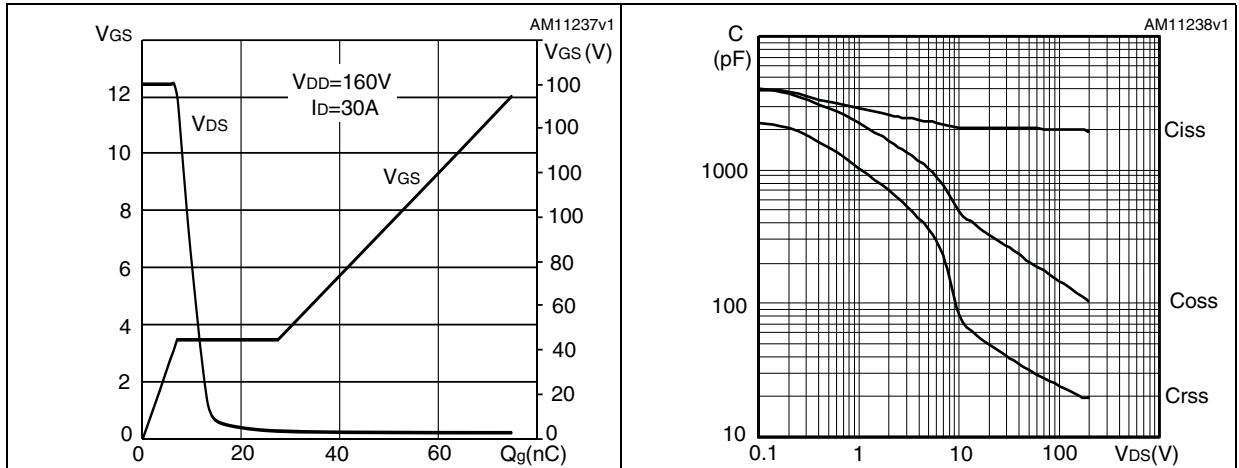

Figure 10. Normalized gate threshold voltage vs temperature Figure 11. Normalized on-resistance vs temperature

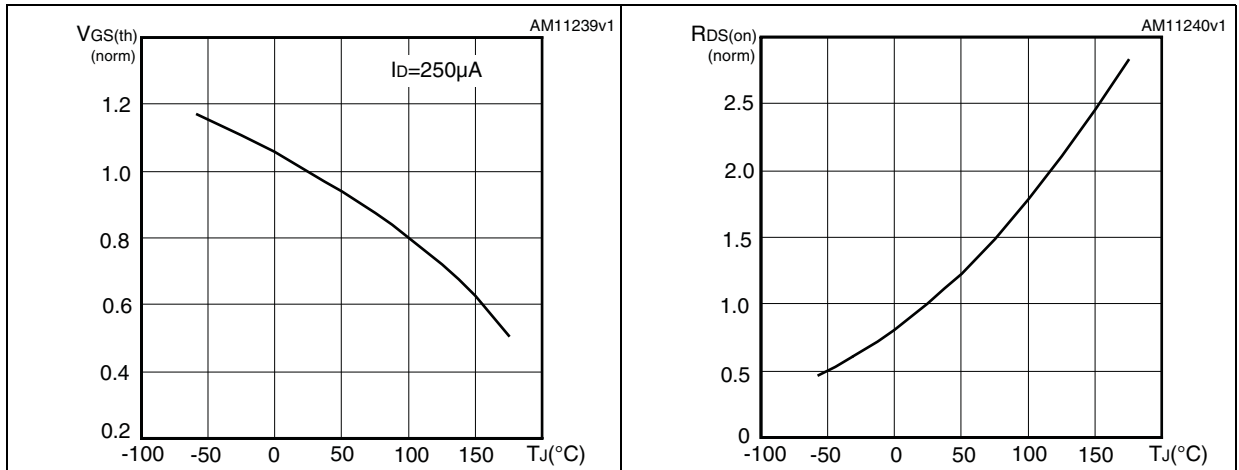
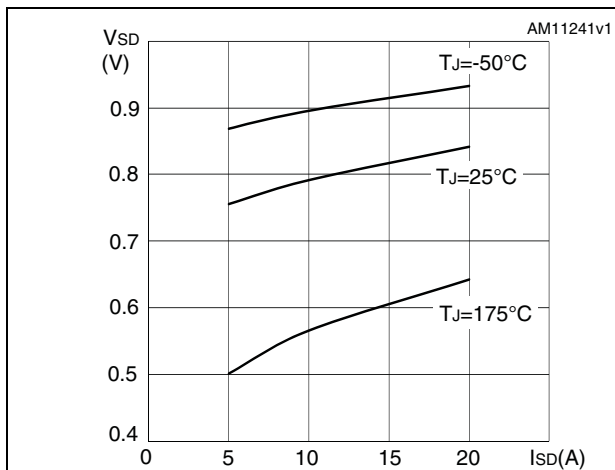

Figure 12. Source-drain diode forward characteristics







## 4 Package mechanical data

In order to meet environmental requirements, ST offers these devices in different grades of ECOPACK® packages, depending on their level of environmental compliance. ECOPACK® specifications, grade definitions and product status are available at: [www.st.com](http://www.st.com). ECOPACK is an ST trademark.

**Table 9. D<sup>2</sup>PAK (TO-263) mechanical data**

Dim.	mm		
	Min.	Typ.	Max.
A	4.40		4.60
A1	0.03		0.23
b	0.70		0.93
b2	1.14		1.70
c	0.45		0.60
c2	1.23		1.36
D	8.95		9.35
D1	7.50		
E	10		10.40
E1	8.50		
e		2.54	
e1	4.88		5.28
H	15		15.85
J1	2.49		2.69
L	2.29		2.79
L1	1.27		1.40
L2	1.30		1.75
R		0.4	
V2	0°		8°

Figure 19. D<sup>2</sup>PAK (TO-263) drawing

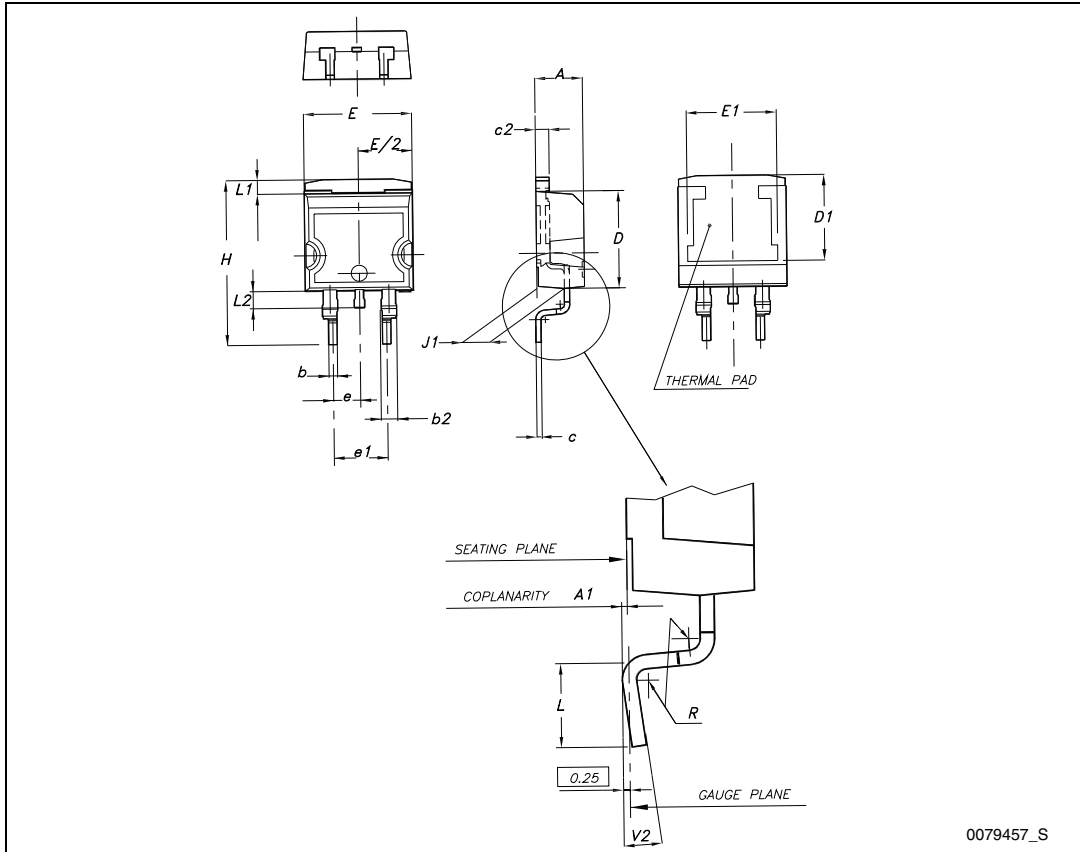
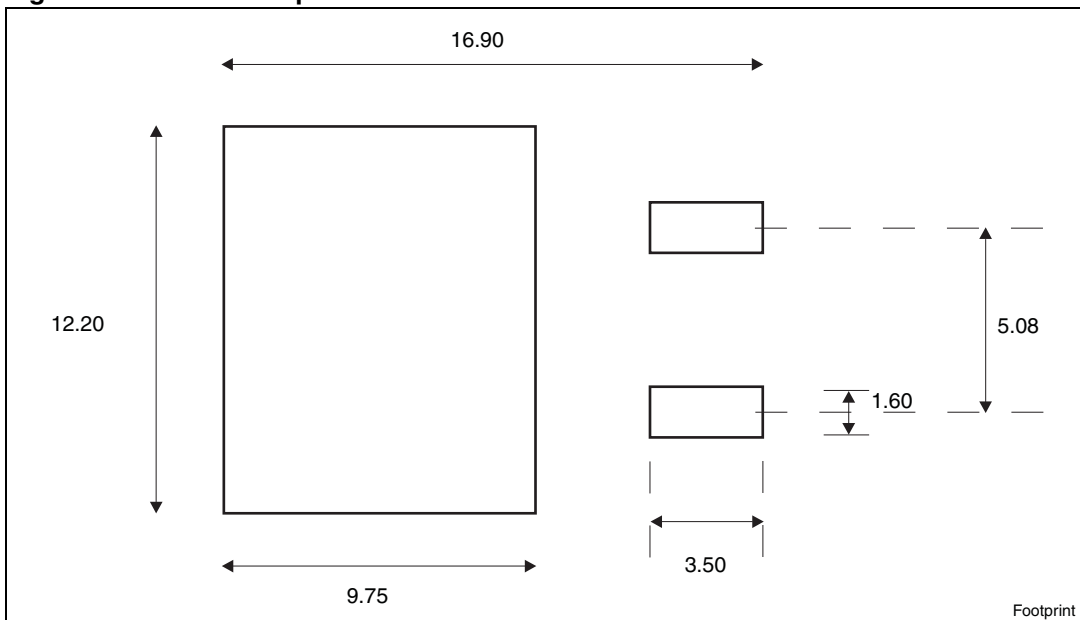

Figure 20. D<sup>2</sup>PAK footprint<sup>(a)</sup>



a. All dimensions are in millimeters.

## 5 Packaging mechanical data

Table 10. D<sup>2</sup>PAK (TO-263) tape and reel mechanical data

Tape			Reel		
Dim.	mm		Dim.	mm	
	Min.	Max.		Min.	Max.
A0	10.5	10.7	A		330
B0	15.7	15.9	B	1.5	
D	1.5	1.6	C	12.8	13.2
D1	1.59	1.61	D	20.2	
E	1.65	1.85	G	24.4	26.4
F	11.4	11.6	N	100	
K0	4.8	5.0	T		30.4
P0	3.9	4.1			
P1	11.9	12.1		Base qty	1000
P2	1.9	2.1		Bulk qty	1000
R	50				
T	0.25	0.35			
W	23.7	24.3			

Figure 21. Tape

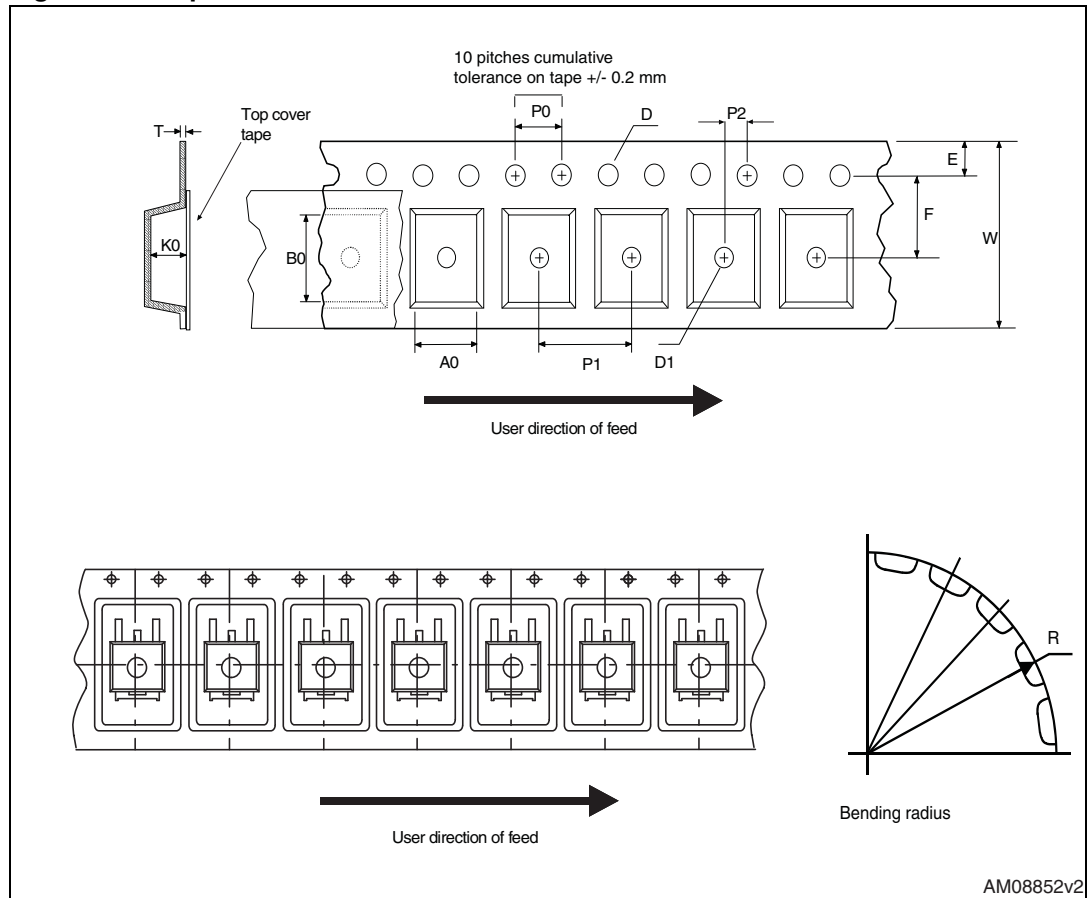
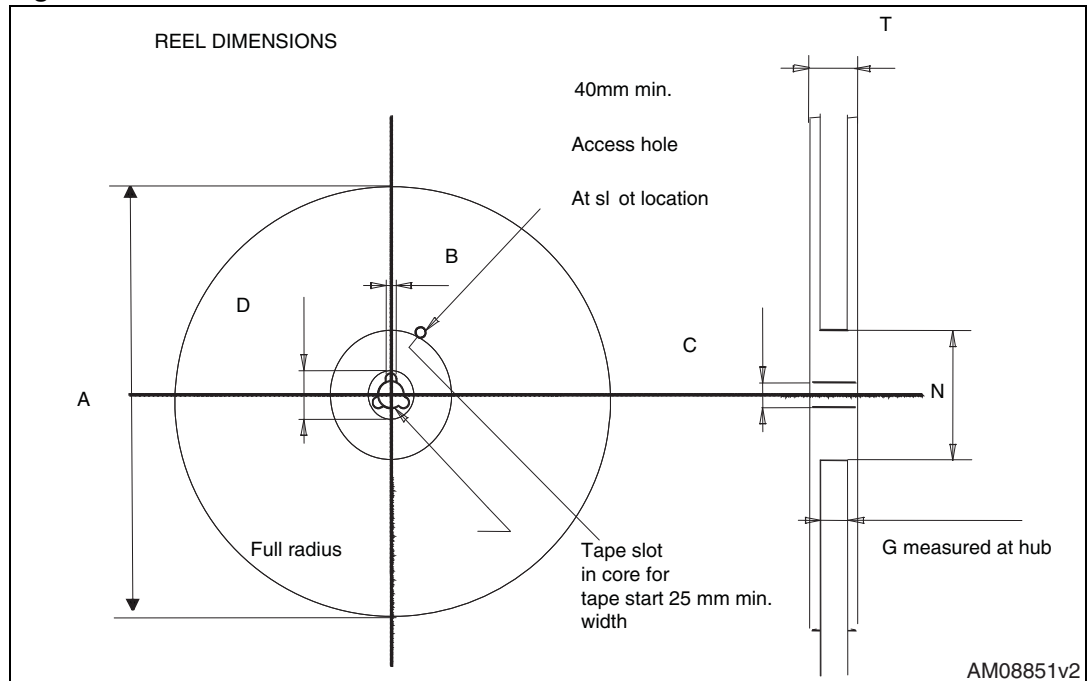

Figure 22. Reel



## 6 Revision history

Table 11. Document revision history

Date	Revision	Changes
01-Feb-2012	1	First release.
07-Mar-2012	2	$P_{TOT}$ in cover page and in <a href="#">Table 2</a> has been updated. <a href="#">Figure 2</a> , <a href="#">Figure 6</a> , <a href="#">Figure 10</a> and <a href="#">Figure 11</a> have been updated.

**Please Read Carefully:**

Information in this document is provided solely in connection with ST products. STMicroelectronics NV and its subsidiaries ("ST") reserve the right to make changes, corrections, modifications or improvements, to this document, and the products and services described herein at any time, without notice.

All ST products are sold pursuant to ST's terms and conditions of sale.

Purchasers are solely responsible for the choice, selection and use of the ST products and services described herein, and ST assumes no liability whatsoever relating to the choice, selection or use of the ST products and services described herein.

No license, express or implied, by estoppel or otherwise, to any intellectual property rights is granted under this document. If any part of this document refers to any third party products or services it shall not be deemed a license grant by ST for the use of such third party products or services, or any intellectual property contained therein or considered as a warranty covering the use in any manner whatsoever of such third party products or services or any intellectual property contained therein.

**UNLESS OTHERWISE SET FORTH IN ST'S TERMS AND CONDITIONS OF SALE ST DISCLAIMS ANY EXPRESS OR IMPLIED WARRANTY WITH RESPECT TO THE USE AND/OR SALE OF ST PRODUCTS INCLUDING WITHOUT LIMITATION IMPLIED WARRANTIES OF MERCHANTABILITY, FITNESS FOR A PARTICULAR PURPOSE (AND THEIR EQUIVALENTS UNDER THE LAWS OF ANY JURISDICTION), OR INFRINGEMENT OF ANY PATENT, COPYRIGHT OR OTHER INTELLECTUAL PROPERTY RIGHT.**

**UNLESS EXPRESSLY APPROVED IN WRITING BY TWO AUTHORIZED ST REPRESENTATIVES, ST PRODUCTS ARE NOT RECOMMENDED, AUTHORIZED OR WARRANTED FOR USE IN MILITARY, AIR CRAFT, SPACE, LIFE SAVING, OR LIFE SUSTAINING APPLICATIONS, NOR IN PRODUCTS OR SYSTEMS WHERE FAILURE OR MALFUNCTION MAY RESULT IN PERSONAL INJURY, DEATH, OR SEVERE PROPERTY OR ENVIRONMENTAL DAMAGE. ST PRODUCTS WHICH ARE NOT SPECIFIED AS "AUTOMOTIVE GRADE" MAY ONLY BE USED IN AUTOMOTIVE APPLICATIONS AT USER'S OWN RISK.**

Resale of ST products with provisions different from the statements and/or technical features set forth in this document shall immediately void any warranty granted by ST for the ST product or service described herein and shall not create or extend in any manner whatsoever, any liability of ST.

ST and the ST logo are trademarks or registered trademarks of ST in various countries.

Information in this document supersedes and replaces all information previously supplied.

The ST logo is a registered trademark of STMicroelectronics. All other names are the property of their respective owners.

© 2012 STMicroelectronics - All rights reserved

STMicroelectronics group of companies

Australia - Belgium - Brazil - Canada - China - Czech Republic - Finland - France - Germany - Hong Kong - India - Israel - Italy - Japan - Malaysia - Malta - Morocco - Philippines - Singapore - Spain - Sweden - Switzerland - United Kingdom - United States of America

[www.st.com](http://www.st.com)

# Mouser Electronics

Authorized Distributor

Click to View Pricing, Inventory, Delivery & Lifecycle Information:

[STMicroelectronics:](#)

[STB30NF20L](#)