

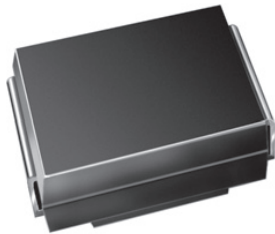

High Power Density Surface Mount TRANSZORB® Transient Voltage Suppressors



DO-214AA (SMB J-Bend)

FEATURES

- Low profile package
- Ideal for automated placement
- Glass passivated pellet chip junction
- Available in uni-directional and bi-directional
- Excellent clamping capability
- Very fast response time
- Low incremental surge resistance
- Meets MSL level 1, per J-STD-020, LF maximum peak of 260 °C
- AEC-Q101 qualified
- Material categorization: for definitions of compliance please see www.vishay.com/doc?99912



RoHS
COMPLIANT

TYPICAL APPLICATIONS

Use in sensitive electronics protection against voltage transients induced by inductive load switching and lighting on ICs, MOSFET, signal lines of sensor units for consumer, computer, industrial, automotive, and telecommunication.

MECHANICAL DATA

Case: DO-214AA (SMB J-Bend)

Molding compound meets UL 94 V-0 flammability rating
Base P/N-E3 - RoHS-compliant, industrial grade
Base P/N-HE3 - RoHS-compliant, AEC-Q101 qualified

Terminals: Matte tin plated leads, solderable per J-STD-002 and JESD 22-B102

E3 suffix meets JESD 201 class 2 whisker test, HE3 suffix meets JESD 201 class 2 whisker test

Polarity: For uni-directional types the color band denotes cathode end, no marking on bi-directional types

PRIMARY CHARACTERISTICS	
V _{BR} (uni-directional)	6.4 V to 49.1 V
V _{BR} (bi-directional)	6.4 V to 49.1 V
V _{WM}	5.0 V to 40 V
P _{PPM} (uni-directional)	1000 W
P _{PPM} (bi-directional)	800 W
I _{FSM} (uni-directional only)	100 A
T _J max.	150 °C
Polarity	Uni-directional, bi-directional
Package	DO-214AA (SMB J-Bend)

MAXIMUM RATINGS (T _A = 25 °C unless otherwise noted)			
PARAMETER	SYMBOL	VALUE	UNIT
Peak pulse power dissipation with a 10/1000 μs waveform (fig. 1)	uni-directional	1000	W
	bi-directional	800	
Peak pulse current with a 10/1000 μs waveform	I _{PPM} ⁽¹⁾	See next table	A
Peak forward surge current 8.3 ms single half sine-wave uni-directional only	I _{FSM} ⁽²⁾	100	A
Operating junction and storage temperature range	T _J , T _{STG}	-55 to +150	°C

Notes

⁽¹⁾ Non-repetitive current pulse, per fig. 3 and derated above T_A = 25 °C per fig. 2

⁽²⁾ Mounted on 0.2" x 0.2" (5.0 mm x 5.0 mm) copper pads to each terminal



UNI-DIRECTIONAL

ELECTRICAL CHARACTERISTICS (T _A = 25 °C unless otherwise noted)								
DEVICE TYPE	DEVICE MARKING CODE	BREAKDOWN VOLTAGE V _{BR} AT I _T ⁽¹⁾ (V)		TEST CURRENT I _T (mA)	STAND-OFF VOLTAGE V _{WM} (V)	MAXIMUM REVERSE LEAKAGE AT V _{WM} I _D (μA)	MAXIMUM PEAK PULSE SURGE CURRENT I _{PPM} ⁽²⁾ (A)	MAXIMUM CLAMPING VOLTAGE AT I _{PPM} V _C (V)
		MIN.	MAX.					
SMB10J5.0A	1AE	6.40	7.07	10	5.0	1000	108.7	9.2
SMB10J6.0A	1AG	6.67	7.37	10	6.0	1000	97.1	10.3
SMB10J6.5A	1AK	7.22	7.98	10	6.5	500	89.3	11.2
SMB10J7.0A	1AM	7.78	8.60	10	7.0	200	83.3	12.0
SMB10J7.5A	1AP	8.33	9.21	1.0	7.5	100	77.5	12.9
SMB10J8.0A	1AR	8.89	9.83	1.0	8.0	50	73.5	13.6
SMB10J8.5A	1AT	9.44	10.4	1.0	8.5	20	69.4	14.4
SMB10J9.0A	1AV	10.0	11.1	1.0	9.0	10	64.9	15.4
SMB10J10A	1AX	11.1	12.3	1.0	10	5.0	58.8	17.0
SMB10J11A	1AZ	12.2	13.5	1.0	11	5.0	54.9	18.2
SMB10J12A	1BE	13.3	14.7	1.0	12	5.0	50.3	19.9
SMB10J13A	1BG	14.4	15.9	1.0	13	1.0	46.5	21.5
SMB10J14A	1BK	15.6	17.2	1.0	14	1.0	43.1	23.2
SMB10J15A	1BM	16.7	18.5	1.0	15	1.0	41.0	24.4
SMB10J16A	1BP	17.8	19.7	1.0	16	1.0	38.5	26.0
SMB10J17A	1BR	18.9	20.9	1.0	17	1.0	36.2	27.6
SMB10J18A	1BT	20.0	22.1	1.0	18	1.0	34.2	29.2
SMB10J20A	1BV	22.2	24.5	1.0	20	1.0	30.9	32.4
SMB10J22A	1BX	24.4	26.9	1.0	22	1.0	28.2	35.5
SMB10J24A	1BZ	26.7	29.5	1.0	24	1.0	25.7	38.9
SMB10J26A	1CE	28.9	31.9	1.0	26	1.0	23.8	42.1
SMB10J28A	1CG	31.1	34.4	1.0	28	1.0	22.0	45.4
SMB10J30A	1CK	33.3	36.8	1.0	30	1.0	20.7	48.4
SMB10J33A	1CM	36.7	40.6	1.0	33	1.0	18.8	53.3
SMB10J36A	1CP	40.0	44.2	1.0	36	1.0	17.2	58.1
SMB10J40A	1CR	44.4	49.1	1.0	40	1.0	15.5	64.5

Notes

- (1) Pulse test: t_p ≤ 50 ms
(2) Surge current waveform per fig. 3 and derate per fig. 2
(3) All terms and symbols are consistent with ANSI/IEEE C62.35
(4) V_F = 3.5 V at I_F = 50 A (uni-directional only)



BI-DIRECTIONAL

ELECTRICAL CHARACTERISTICS ($T_A = 25\text{ }^\circ\text{C}$ unless otherwise noted)								
DEVICE TYPE	DEVICE MARKING CODE	BREAKDOWN VOLTAGE V_{BR} AT I_T ⁽¹⁾ (V)		TEST CURRENT I_T (mA)	STAND-OFF VOLTAGE V_{WM} (V)	MAXIMUM REVERSE LEAKAGE AT V_{WM} I_D (μA)	MAXIMUM PEAK PULSE SURGE CURRENT I_{PPM} ⁽²⁾ (A)	MAXIMUM CLAMPING VOLTAGE AT I_{PPM} V_C (V)
		MIN.	MAX.					
SMB8J5.0CA	1AE	6.40	7.25	10	5.0	2000	87.0	9.2
SMB8J6.0CA	1AG	6.67	7.37	10	6.0	2000	77.7	10.3
SMB8J6.5CA	1AK	7.22	7.98	10	6.5	1000	71.4	11.2
SMB8J7.0CA	1AM	7.78	8.60	10	7.0	400	66.7	12.0
SMB8J7.5CA	1AP	8.33	9.21	1.0	7.5	200	62.0	12.9
SMB8J8.0CA	1AR	8.89	9.83	1.0	8.0	100	58.8	13.6
SMB8J8.5CA	1AT	9.44	10.4	1.0	8.5	40	55.6	14.4
SMB8J9.0CA	1AV	10.0	11.1	1.0	9.0	20	51.9	15.4
SMB8J10CA	1AX	11.1	12.3	1.0	10	10	47.1	17.0
SMB8J11CA	1AZ	12.2	13.5	1.0	11	5.0	44.0	18.2
SMB8J12CA	1BE	13.3	14.7	1.0	12	5.0	40.2	19.9
SMB8J13CA	1BG	14.4	15.9	1.0	13	1.0	37.2	21.5
SMB8J14CA	1BK	15.6	17.2	1.0	14	1.0	34.5	23.2
SMB8J15CA	1BM	16.7	18.5	1.0	15	1.0	32.8	24.4
SMB8J16CA	1BP	17.8	19.7	1.0	16	1.0	30.8	26.0
SMB8J17CA	1BR	18.9	20.9	1.0	17	1.0	29.0	27.6
SMB8J18CA	1BT	20.0	22.1	1.0	18	1.0	27.4	29.2
SMB8J20CA	1BV	22.2	24.5	1.0	20	1.0	24.7	32.4
SMB8J22CA	1BX	24.4	26.9	1.0	22	1.0	22.5	35.5
SMB8J24CA	1BZ	26.7	29.5	1.0	24	1.0	20.6	38.9
SMB8J26CA	1CE	28.9	31.9	1.0	26	1.0	19.0	42.1
SMB8J28CA	1CG	31.1	34.4	1.0	28	1.0	17.6	45.4
SMB8J30CA	1CK	33.3	36.8	1.0	30	1.0	16.5	48.4
SMB8J33CA	1CM	36.7	40.6	1.0	33	1.0	15.0	53.3
SMB8J36CA	1CP	40.0	44.2	1.0	36	1.0	13.8	58.1
SMB8J40CA	1CR	44.4	49.1	1.0	40	1.0	12.4	64.5

Notes

- (1) Pulse test: $t_p \leq 50\text{ ms}$
(2) Surge current waveform per fig. 3 and derate per fig. 2
(3) All terms and symbols are consistent with ANSI/IEEE C62.35

THERMAL CHARACTERISTICS ($T_A = 25\text{ }^\circ\text{C}$ unless otherwise noted)			
PARAMETER	SYMBOL	VALUE	UNIT
Typical thermal resistance, junction to ambient ⁽¹⁾	$R_{\theta JA}$	72	$^\circ\text{C/W}$
Typical thermal resistance, junction to lead	$R_{\theta JL}$	20	

Note

- (1) Mounted on minimum recommended pad layout

ORDERING INFORMATION (Example)				
PREFERRED P/N	UNIT WEIGHT (g)	PREFERRED PACKAGE CODE	BASE QUANTITY	DELIVERY MODE
SMB10J5.0A-E3/52	0.106	52	750	7" diameter plastic tape and reel
SMB10J5.0A-E3/5B	0.106	5B	3200	13" diameter plastic tape and reel
SMB10J5.0AHE3/52 ⁽¹⁾	0.106	52	750	7" diameter plastic tape and reel
SMB10J5.0AHE3/5B ⁽¹⁾	0.106	5B	3200	13" diameter plastic tape and reel

Note

- (1) AEC-Q101 qualified

RATINGS AND CHARACTERISTICS CURVES ($T_A = 25\text{ }^\circ\text{C}$ unless otherwise noted)

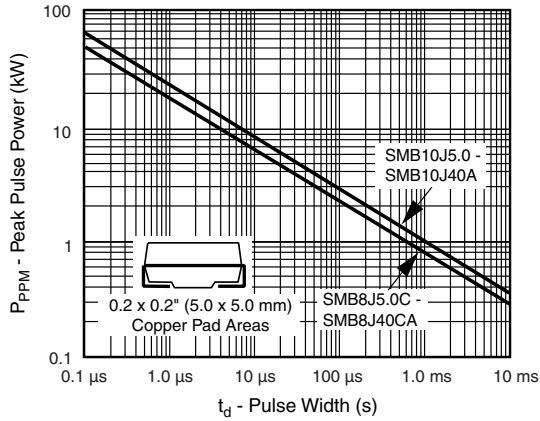

Fig. 1 - Peak Pulse Power Rating Curve

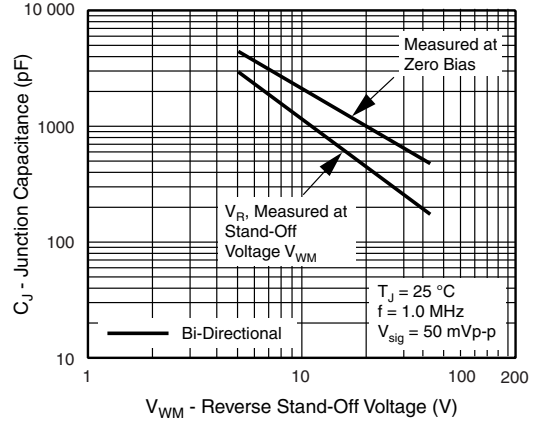

Fig. 4 - Typical Junction Capacitance

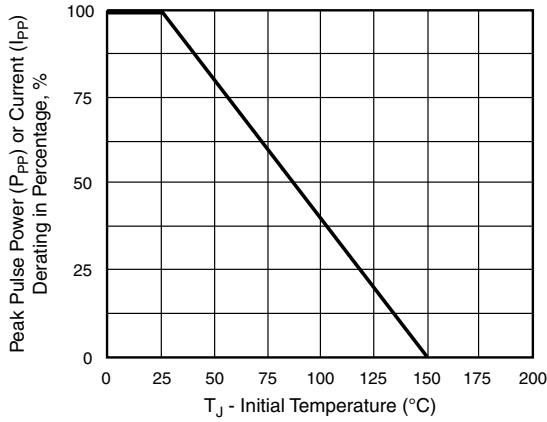

Fig. 2 - Pulse Power or Current vs. Initial Junction Temperature

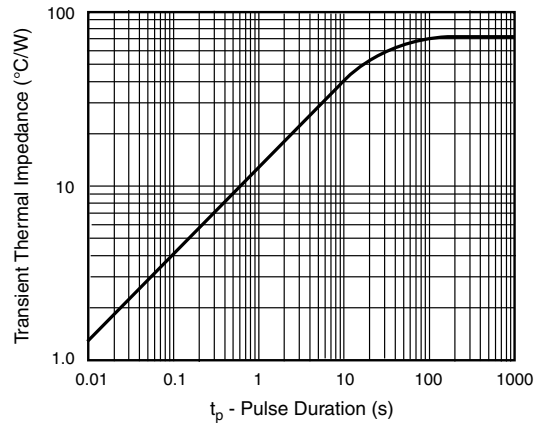

Fig. 5 - Typical Transient Thermal Impedance

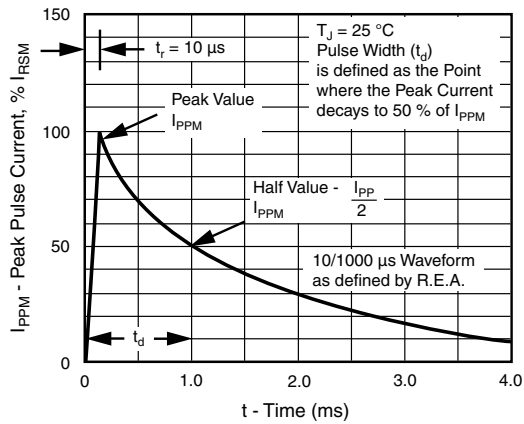

Fig. 3 - Pulse Waveform

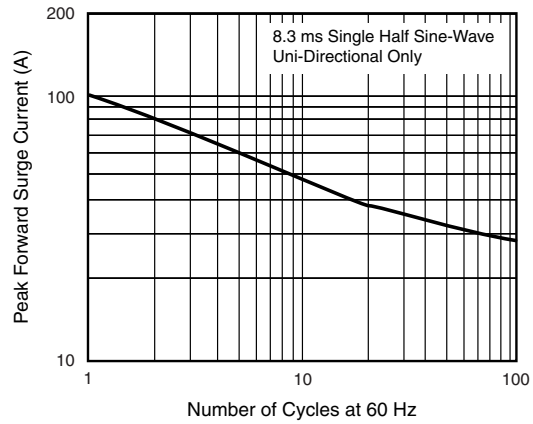
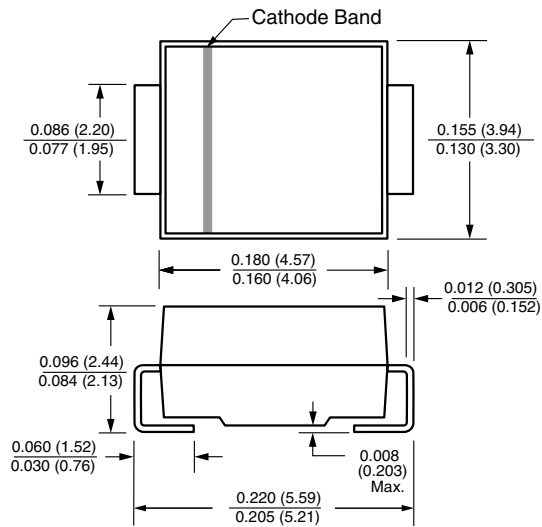

Fig. 6 - Maximum Non-Repetitive Forward Surge Current



PACKAGE OUTLINE DIMENSIONS in inches (millimeters)

DO-214AA (SMB J-Bend)



Mounting Pad Layout

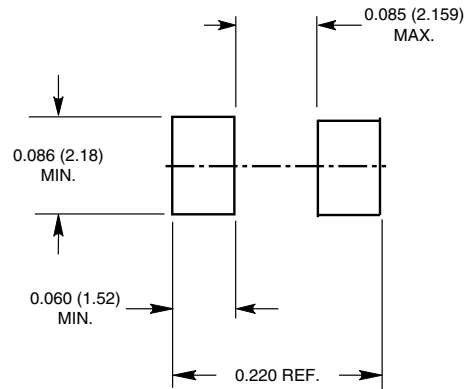



Disclaimer

ALL PRODUCT, PRODUCT SPECIFICATIONS AND DATA ARE SUBJECT TO CHANGE WITHOUT NOTICE TO IMPROVE RELIABILITY, FUNCTION OR DESIGN OR OTHERWISE.

Vishay Intertechnology, Inc., its affiliates, agents, and employees, and all persons acting on its or their behalf (collectively, "Vishay"), disclaim any and all liability for any errors, inaccuracies or incompleteness contained in any datasheet or in any other disclosure relating to any product.

Vishay makes no warranty, representation or guarantee regarding the suitability of the products for any particular purpose or the continuing production of any product. To the maximum extent permitted by applicable law, Vishay disclaims (i) any and all liability arising out of the application or use of any product, (ii) any and all liability, including without limitation special, consequential or incidental damages, and (iii) any and all implied warranties, including warranties of fitness for particular purpose, non-infringement and merchantability.

Statements regarding the suitability of products for certain types of applications are based on Vishay's knowledge of typical requirements that are often placed on Vishay products in generic applications. Such statements are not binding statements about the suitability of products for a particular application. It is the customer's responsibility to validate that a particular product with the properties described in the product specification is suitable for use in a particular application. Parameters provided in datasheets and / or specifications may vary in different applications and performance may vary over time. All operating parameters, including typical parameters, must be validated for each customer application by the customer's technical experts. Product specifications do not expand or otherwise modify Vishay's terms and conditions of purchase, including but not limited to the warranty expressed therein.

Except as expressly indicated in writing, Vishay products are not designed for use in medical, life-saving, or life-sustaining applications or for any other application in which the failure of the Vishay product could result in personal injury or death. Customers using or selling Vishay products not expressly indicated for use in such applications do so at their own risk. Please contact authorized Vishay personnel to obtain written terms and conditions regarding products designed for such applications.

No license, express or implied, by estoppel or otherwise, to any intellectual property rights is granted by this document or by any conduct of Vishay. Product names and markings noted herein may be trademarks of their respective owners.

Mouser Electronics

Authorized Distributor

Click to View Pricing, Inventory, Delivery & Lifecycle Information:

Vishay:

[SMB10J10A-E3/2C](#) [SMB10J10A-E3/51](#) [SMB10J10A-E3/52](#) [SMB10J10A-E3/55](#) [SMB10J10A-E3/5B](#)
[SMB10J10AHE3/2C](#) [SMB10J10AHE3/52](#) [SMB10J10AHE3/55](#) [SMB10J10AHE3/5B](#) [SMB10J10-E3/2C](#) [SMB10J10-E3/51](#) [SMB10J10-E3/52](#) [SMB10J10-E3/55](#) [SMB10J10-E3/5B](#) [SMB10J10HE3/2C](#) [SMB10J10HE3/52](#)
[SMB10J10HE3/55](#) [SMB10J10HE3/5B](#) [SMB10J11A-E3/2C](#) [SMB10J11A-E3/51](#) [SMB10J11A-E3/52](#) [SMB10J11A-E3/55](#) [SMB10J11A-E3/5B](#) [SMB10J11AHE3/2C](#) [SMB10J11AHE3/52](#) [SMB10J11AHE3/55](#) [SMB10J11AHE3/5B](#)
[SMB10J11-E3/2C](#) [SMB10J11-E3/51](#) [SMB10J11-E3/52](#) [SMB10J11-E3/55](#) [SMB10J11-E3/5B](#) [SMB10J11HE3/2C](#) [SMB10J11HE3/52](#) [SMB10J11HE3/55](#) [SMB10J11HE3/5B](#) [SMB10J12A-E3/2C](#) [SMB10J12A-E3/51](#) [SMB10J12A-E3/52](#)
[SMB10J12A-E3/55](#) [SMB10J12A-E3/5B](#) [SMB10J12AHE3/2C](#) [SMB10J12AHE3/52](#) [SMB10J12AHE3/55](#) [SMB10J12AHE3/5B](#) [SMB10J12-E3/2C](#) [SMB10J12-E3/51](#) [SMB10J12-E3/52](#) [SMB10J12-E3/55](#) [SMB10J12-E3/5B](#)
[SMB10J12HE3/2C](#) [SMB10J12HE3/52](#) [SMB10J12HE3/55](#) [SMB10J12HE3/5B](#) [SMB10J13A-E3/2C](#) [SMB10J13A-E3/51](#) [SMB10J13A-E3/52](#) [SMB10J13A-E3/55](#) [SMB10J13A-E3/5B](#) [SMB10J13AHE3/2C](#) [SMB10J13AHE3/52](#)
[SMB10J13AHE3/55](#) [SMB10J13AHE3/5B](#) [SMB10J13-E3/2C](#) [SMB10J13-E3/51](#) [SMB10J13-E3/52](#) [SMB10J13-E3/55](#) [SMB10J13-E3/5B](#) [SMB10J13HE3/2C](#) [SMB10J13HE3/52](#) [SMB10J13HE3/55](#) [SMB10J13HE3/5B](#) [SMB10J14A-E3/2C](#)
[SMB10J14A-E3/51](#) [SMB10J14A-E3/52](#) [SMB10J14A-E3/55](#) [SMB10J14A-E3/5B](#) [SMB10J14AHE3/2C](#) [SMB10J14AHE3/52](#) [SMB10J14AHE3/55](#) [SMB10J14AHE3/5B](#) [SMB10J14-E3/2C](#) [SMB10J14-E3/51](#) [SMB10J14-E3/52](#)
[SMB10J14-E3/55](#) [SMB10J14-E3/5B](#) [SMB10J14HE3/2C](#) [SMB10J14HE3/52](#) [SMB10J14HE3/55](#) [SMB10J14HE3/5B](#) [SMB10J15A-E3/2C](#) [SMB10J15A-E3/51](#) [SMB10J15A-E3/52](#) [SMB10J15A-E3/55](#) [SMB10J15A-E3/5B](#)
[SMB10J15AHE3/2C](#) [SMB10J15AHE3/52](#) [SMB10J15AHE3/55](#) [SMB10J15AHE3/5B](#) [SMB10J15-E3/2C](#)